



THE COUNTY OF GALVESTON

RUFUS G. CROWDER, CPPO, CPPB
PURCHASING AGENT

GWEN MCLAREN, CPPB
ASST. PURCHASING AGENT

COUNTY COURTHOUSE
722 Moody (21st Street)
Fifth (5th) Floor
GALVESTON, TEXAS 77550

February 23, 2021

PROJECT NAME: Galveston Seawall Rip Rap Deficiencies West of 61st Street

SOLICITATION NO: ITB #B211026

RE: ADDENDUM #1

To All Prospective Proposers,

The following information is being provided to aid in preparation of your bid submittal:

Due to Winter Storm Uri that affected Galveston County last week the timeline for Bid #B211026, Galveston Seawall Rip Rap Deficiencies West of 61st Street has been revised:

- **Pre-Bid video/tele-conference:** **Tuesday, March 2, 2021 at 10:00 a.m.**

The Pre-Bid Conference shall take place via video/tele-conference and the instructions are listed below and on the County's Purchasing website:

Minimum System Requirements for Video Conferencing:

1. High-resolution webcam;
2. Computer processing minimum: 2 GB of RAM and a quad-core processor;
3. Network bandwidth: 1 Mbps is sufficient for 15 fps at 720p resolution;

Calling from a mobile device:

1. Front facing camera;
2. In ear headphone with built in mic

Instructions for Video Conferencing:

1. [Click here](#) or navigate to <https://guest.lifesize.com/1907077>;
2. Enter Name and email (optional);
3. Click the Terms of Service and Privacy Policy checkbox;
4. Click Join Meeting

***Note - be sure to enable audio and video.**

- **Questions Deadline:** **Friday, March 5, 2021; by 5:00 p.m.**
- **Bid Opening:** **Thursday, March 18, 2021; at 2:00 p.m.**

As a reminder, all questions regarding this solicitation must be submitted in writing to:

Rufus G. Crowder, CPPO CPPB
Galveston County Purchasing Agent
722 Moody, Fifth (5th) Floor
Galveston, Texas 77550
E-mail: purchasing.bids@co.galveston.tx.us

If you have any further questions regarding this proposal, please address them to Rufus Crowder, CPPO CPPB, Purchasing Agent, via e-mail at purchasing.bids@co.galveston.tx.us, or contact the Purchasing Department at (409) 770-5371.

Please excuse us for any inconvenience that this may have caused.

Sincerely,

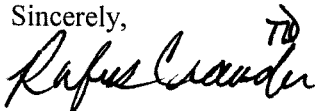

Rufus G. Crowder, CPPO CPPB
Purchasing Agent
Galveston County



THE COUNTY OF GALVESTON

RUFUS G. CROWDER, CPPO, CPPB
PURCHASING AGENT

GWEN MCLAREN, CPPB
ASST. PURCHASING AGENT

COUNTY COURTHOUSE
722 Moody (21st Street)
Fifth (5th) Floor
GALVESTON, TEXAS 77550

March 10, 2021

PROJECT NAME: Galveston Seawall Rip Rap Deficiencies West of 61st Street

SOLICITATION NO: ITB #B211026

RE: ADDENDUM #2

To All Prospective Bidders,

The following information is being provided to aid in preparation of your proposal submittal(s):

REVISED BID OPENING DATE:

Bid #B211026, Galveston Seawall Rip Rap Deficiencies West of 61st Street scheduled to be opened on Thursday, March 4, 2021 at 2:00 P.M. has been re-scheduled.

The new deadline for submitting a bid is as follows:

Date: Thursday, March 18, 2021

Time: 2:00 P.M.

Question #1: *Sheet 2 of 39 states, "No part of the crane including the outriggers shall be placed on the existing sidewalk. Only a rubber-tired crane will be permitted." Are outriggers allowed to be used on the street?*

Response: Outriggers will be allowed to be used on the street with proper matting. Outriggers must not be placed on the sidewalk no matter what type of matting is used.

Question #2: *Why are no track machines allowed? The exclusive requirement of rubber tired machines not only makes the work more difficult, but more expensive. Requiring track machines to also mat would reduce the ground pressure.*

Response: The State has recently overlaid FM 3005 and to minimize the potential of damage to the roadway tracked vehicles are not permitted.

**Galveston Seawall Rip Rap Deficiencies West of 61st Street
Addendum 2**

Question #3: *If track machines were allowed if matted, would working on top of the sidewalk be entertained? Gaining an additional 10'-15' would drastically affect the equipment required.*

Response: All equipment must remain on the roadway and parking area, no equipment or part of equipment shall be placed on the sidewalk.

Question #4: *What date will the pre-bid be re-schedule to?*

Response: The pre-bid meeting was rescheduled for Tuesday, March 2, 2021 at 10:00 a.m.

Question #5: *Is the bid date going to be extended?*

Response: The bid due date has been extended to 2:00 P.M. CST, on Thursday, March 18, 2021.

Question #6: *Why is this not a Corp of Engineers project and is a Galveston County?*

Response: Galveston County, not the Corps of Engineers, owns the Seawall from Beach Road to the west end of the Seawall.

Question #7: *The existing stones are severely irregular shaped and real irregular in place (i.e. probably moved around during Ike). It does not like the plans show even existing surface.*

Response: The areas defined on the plans is where the rock is to be placed. The contractor will place the rock as close to the lines shown on the plans. It is not the intent to have a completely flat surface when placing the new blocks on top of the existing.

Question #8: *How is the contractor to make an even surface in which the new stoned are placed<is the contractor to fill the voids with loose crushed concrete to make an even surface. Or remove the existing stones which water would then erode Subgrade or?*

Response: The intent is not to have an even level surface where prohibited by the existing conditions. No, work is to be performed to level up the existing surface. The new blocks will be placed on top of the existing surface as neatly as conditions will permit.

Question #9: *It seems like the only constructable method per plan design would be*
a. Sheetpile a few feet outside each section after removing a few stones in the line of sheetpile. (i.e. a cofferdam)
b. Remove all existing severely eroded and moved stones
c. Pump water while placing leveling sand
d. Pump water while placing stones
e. Remove piling and place old stones in void between old stones and new stones

Very expensive. Way to too low Engineers estimate. What happed if this proves to be true? Rebid? Find more funds? Or?

**Galveston Seawall Rip Rap Deficiencies West of 61st Street
Addendum 2**

Response: None of the items of work as questioned are required. This project is to place the blocks as close to the plans as conditions will permit. The granite blocks serve as an erosion measure to protect the seawall from direct forces of wave action.

Question #10: *FURNISH/INSTALL GRANITE DERRICK STONE EA 2095
What company supplies this specialized stone. Not in specs. We cannot find a company on website.*

Response: Coldspring – Daniel Pfannenstein 320-685-4615
ASL Stone – Gretchen Linn 817-727-5939

Question #11: *CONSTRUCT DETOURS LS 1 Parts of TC Plan is difficult to follow
What is beginning and ending stations for temp asphalt crossover shown on sheet 15
Where is pay item and LF quantity for removing and replacing curb
Is the 2" new asphalt placed on new 6" asphalt stabilized base? Are the 2 red lines shown the new curb? If yes, it looks like the end points are blunt curb ends in the middle of the two roads? ????*

Response: The temporary crossover is transitioned over the existing median. The only pavement that will be constructed is in between the existing roadway. The red lines shown on the plan are simply the width of the cross over and the location of the temporary striping. The crossover will not be curbed, and the removal of the existing curb is outside of the crossover area. This crossover is paid for under Construct Detours, lump sum. This lump sum price includes restoring the crossover area back to pre-construction conditions.

Question #12: *Per plan sheet 2: please advise as to what permits and licenses will be required by the C.o. Galveston.*

Response: This project falls under the maintenance agreement and no federal, county or state permits (other than the TxDOT traffic control approval) are required. The City of Galveston will require a permit.

Question #13: *Per plan sheet 2: per 1 column, 7th paragraph; please advise as to the comment: "no equipment on the existing toe". Per a site visit and sheet no. 3; the drawing referencing typical section A show a level across the top of the proposed 6 ea. blocks. Without adding level of bedding rock, stacking the blocks on the existing material will not result in a +/- level top between from 1st through 6th block. If the level up bedding material is incidental; clarification is critical to identify the scope of the project.*

Response: No leveling is required. The new blocks will be placed on top of the existing surface as neatly as conditions will permit.

Question #14: *Per plan sheet 2: is station 10+00 the west end of the seawall? Regarding the note to show stations; it is critical to identify where 10+00 is.*

Response: Station 10+00 is the western most end of the seawall.

**Galveston Seawall Rip Rap Deficiencies West of 61st Street
Addendum 2**

Question #15: *Is a field office required and is a chain link fence required to establish a boundary between the public access and project staging area boundaries during the project? Please clarify if the existing fence on the beach side of Diamond Beach facility is to be connected to the lay down area at the east corner and limits.*

Response: No field trailer is required. The entire parking area behind the Diamond Beach facility will be closed off for the contractor staging and laydown area.

Question #16: *Per plan sheet 2: the second column, second paragraph mentions a pre con meeting requirement to show plan to secure the project site and suspend work due to a forecasted storm event. Further in second column, 4th paragraph mentions “no significant traffic generator events have been identified”. Please clarify if work might be suspended for tourist season or i.e. “Bicker Weekend” or any tourist event that may require a temporary demobilization or traffic control take down and re install.*

Response: There is no anticipated suspension of work for special events. If the City demands a suspension of work, this will be discussed and possibly handed in a change order.

Question #17: *Per plan sheet 2: 2nd column, 7th paragraph mentions “120 day installation period will not be added to”. Can the applicable traffic control plan and installation be scheduled just prior to the block arrivals? It is recommended that the existing traffic not be an inconvenience to the public until it is required, and the overall traffic control is and expensive item. Please consider and clarify.*

Response: Yes, the 120 days is after the block begins to arrive on site. The schedule has 60 days built into it to allow for production of the blocks. The overall construction duration is 180 calendar days. The traffic should not be impacted until the contractor is ready to place the blocks. Refer to page 85 of the specifications.

Question #18: *I noticed no cones in the traffic control plan. Are they allowed?*

Response: Traffic cones are not permitted, per TxDOT’s approval of the traffic plan.

Question #19: *Per plan sheet 3: Regarding note @ top right of sheet; actual field conditions vary significantly more than “slightly”. Please acknowledge.*

Response: Concur, the new blocks will be placed on top of the existing surface as neatly as conditions will permit.

Question #20: *Per plan sheet no. 5: does the 1st block section start @ sta. 10+75?*

Response: The plans call out 10+73 but since this run of blocks goes to the stairs, we would recommend working from the stairs back to the beginning.

**Galveston Seawall Rip Rap Deficiencies West of 61st Street
Addendum 2**

Question #21: *From early discussions with potential suppliers from the U.S. and around the world; the timing to get the blocks produced at the quarry and delivered to the site is” 2-3 months”. The specifications mention 120 days for installation. Can the days for installation start being charged after delivery starts? Comments have been received that mentions the engineer’s estimated bid amount @ \$2.2mm is considerably low for the project. Will the project be awarded if the bids are significantly higher than the estimated bid amount?*

Response: Yes, the 120 days is after the block begins to arrive on site. The schedule has 60 days built into it to allow for production of the blocks. The overall construction duration is 180 calendar days. Refer to page 85 of the specifications.

Prepare your bids as you feel appropriate. The County will have the option to reject, accept and or rebid the project whichever is in their best interest.

Question #22: *Sheet no. 2: General notes / left column, 5th paragraph: “procure permits and licenses which are to be issued by the city, county or M.U.D”. At top of middle column, 1st paragraph: “the work fall under the maintenance and repair section of the permit associated with U.S. Army Corps of Engineers (USACE) permit area. Therefore, no additional permits are required.” Please clarify duty of the contractor.*

Response: This project falls under the maintenance agreement and no federal, county or state permits (other than the TxDOT traffic control approval) are required. The City of Galveston will require a permit.

Question #23: *Sheet no. 2: middle column 5th paragraph down: “The anticipated construction duration after derrick stones begin to arrive at the project sited is 120 calendar days. Construction is limited to daylight hours only”. In the 17th paragraph down / middle column; “use of cones for daylight time work only. Replace cones with plastic barrels during night time hours. Please clarify if night time hours work is allowed.*

Response: No nighttime work is permitted. The traffic control will be as shown and approved by TxDOT.

Question #24: *If bids are received 3/18/2021; when is anticipated notice to proceed? It is respectfully requested that a “notice of intent to award” be issued to allow the prospective quarry to cut the stones required for the proposed 120 calendar day installation period. Please clarify.*

Response: The anticipated award of the contract and notice to proceed will be around June 1. The 120 days for installation is after the block begins to arrive on site. The schedule has 60 days built into it to allow for production of the blocks. The overall construction duration is 180 calendar days. Refer to page 85 of the specifications.

**Galveston Seawall Rip Rap Deficiencies West of 61st Street
Addendum 2**

Question #25: *P84 of states that a 12 month warranty from the date of final acceptance. Please clarify that damage to the new stone due to inclement weather is not the responsibility of the contractor.*

Response: If the granite stone provided meets the specifications, the contractor is not responsible for damage to the stones due to inclement weather.

Question #26: *P88, #46 states that the “Contractor shall be responsible for obtaining and furnishing all necessary permits and licenses, City, County, State or Federal as are required for the performance of the work”. can you clarify exactly which permits will be the contractors responsibility?*

Response: This project falls under the maintenance agreement and no federal, county or state permits (other than the TxDOT traffic control approval) are required. The City of Galveston will require a permit.

Question #27: *P88, #51 states “Work shall not be commenced by the contractor before sunrise and shall be so conducted that all equipment is off the road and safely stored by sunset.” When working West of the staging area, will we be required to store all equipment in the staging area at the end of each day?*

Response: The entire parking area behind the Diamond Beach facility will be closed off for the contractor staging and laydown area. Equipment shall be moved and stored at this location each night.

Question #28: *P88, #51 states “Work shall not be commenced by the contractor before sunrise and shall be so conducted that all equipment is off the road and safely stored by sunset.” Is working 7 days/week allowed?*

Response: Yes, working weekends is permitted.

Question #29: *The plans state the no permits and no SWPPP are required by contractor. Specifications say permits and SWPPP are required. Please clarify.*

Response: This project falls under the maintenance agreement and no federal, county or state permits (other than the TxDOT traffic control approval) are required. The City of Galveston will require a permit. A SWPPP is not required.

Question #30: *Will you consider allowing equipment on the toe stone?*

Response: No equipment will be allowed on the toe stone or in the Gulf of Mexico.

**Galveston Seawall Rip Rap Deficiencies West of 61st Street
Addendum 2**

Question #31: Will you consider allowing equipment with steel tracks assuming they stay on wood mats?

Response: The State has recently overlaid FM 3005 and to minimize the potential of damage to the roadway tracked vehicles are not permitted.

Question #32: The plans specify that equipment is not allowed on the sidewalk/walkway. Will you allow equipment on the sidewalk assuming they are on wood mats?

Response: No equipment will be allowed on sidewalk.

Question #33: Is structural integrity of the sidewalk/seawall a concern if large equipment was allowed on the sidewalk?

Response: Yes, no equipment will be allowed on sidewalk.

Question #34: List of suppliers

Response: Coldspring – Daniel Pfannenstein 320-685-4615
ASL Stone – Gretchen Linn 817-727-5939

Question #35: Necessary permits? City?

Response: This project falls under the maintenance agreement and no federal, county or state permits (other than the TxDOT traffic control approval) are required. The City of Galveston will require a permit.

Question #36: Laydown area? Behind diamond beach?

Response: The entire parking area behind the Diamond Beach facility will be closed off for the contractor staging and laydown area.

Question #37: Traffic control phases. Can we take phase 1 down before 2?

Response: Any change in the traffic control phasing must be presented to the construction manager for consideration and coordination with TxDOT, County and the City.

Question #38: Construction phasing

Response: The limits and timing of work to be performed with respect to construction phasing will be considered if it is in the best interest of the County and City.

**Galveston Seawall Rip Rap Deficiencies West of 61st Street
Addendum 2**

Question #39: *There is a couple places in the documents that talks about fencing in the project with orange safety fencing or chain link but does not call it out on the plans?*

Response: No orange safety fencing or chain link fencing will be required in this project.

Question #40: *What will be the maximum tolerable gap between each new stone placed*

Response: The maximum gap between each Granite Derrick Stone is 3-5 inches. This spacing should be limited to the spaces parallel to the seawall. The spacing perpendicular to the seawall should be as small as possible.

Question #41: *How will a Mobe / Demobe be handled in the event of a storm or a City event that we have to open all lanes. The project is kicking off at the start of Hurricane season.*

Response: In the unforeseen chance the City rules the street must open, the County Engineer will inform the Contractor at the earliest possible. The Contractor will need to remove all traffic control barricades, secure equipment, and secure the project site. Once the County Engineer deems it safe the Contractor will need to place all traffic control barricades. If this situation occurs a change order may be approved.

Question #42: *Will Galveston county consider the use of precast concrete blocks of equal size as specified*

Response: Concrete blocks of the same dimensions will not be permitted as a substitute to the granite derrick stones. This type of material has been used in the past and has not performed as well as the specified material.

As a reminder, all questions regarding this proposal must be submitted in writing to:

Rufus G. Crowder, CPPO CPPB
Galveston County Purchasing Agent
722 Moody, Fifth (5th) Floor
Galveston, Texas 77550
E-mail: purchasing.bids@co.galveston.tx.us

If you have any further questions regarding this proposal, please address them to Rufus Crowder, CPPO CPPB, Purchasing Agent, via e-mail at purchasing.bids@co.galveston.tx.us, or contact the Purchasing Department at (409) 770-5371.

Please excuse us for any inconvenience that this may have caused.

Sincerely,

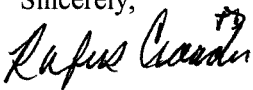

Rufus G. Crowder, CPPO CPPB
Purchasing Agent
Galveston County

INDEX OF SHEETS

SHEET NO	DESCRIPTION
1	COVER SHEET
2	GENERAL NOTES AND QUANTITIES
3-4	TYPICAL SECTION TOE PROTECTION
5-13	PLAN VIEW
14	MAINTENANCE OF TRAFFIC NOTES
15	TEMPORARY ASPHALT CROSSOVER DETAIL
16-25	MAINTENANCE OF TRAFFIC
26-37	BC(1)-14 - BC(12)-14
38	TCP(1-4)-18
39	WZ(TD)-17

GALVESTON SEAWALL RIP RAP DEFICIENCIES WEST OF 61st STREET

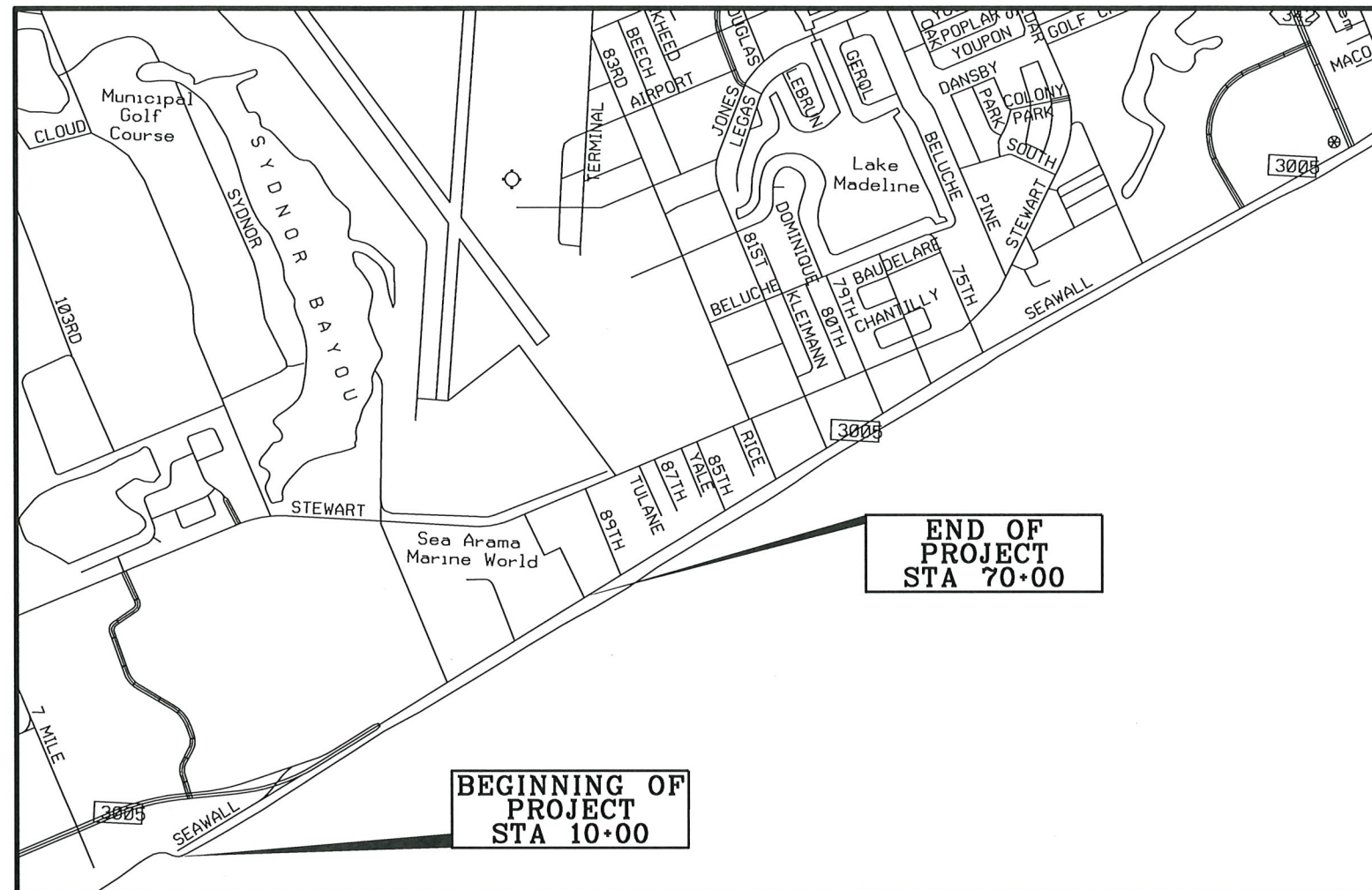

PROJECT LOCATION
SCALE: N.T.S.

COUNTY OF GALVESTON
GALVESTON, TEXAS 77550

GALVESTON SEAWALL DATUM STATEMENT:

1. ALL COORDINATES ARE REFERENCED TO THE TEXAS COORDINATE SYSTEM, SOUTH CENTRAL ZONE (4204), NAD 1983(CONUS), GEOID12A. HORIZONTAL CONTROL WAS ESTABLISHED BY GPS OBS (RTN) UTILIZING ALLTERRA CENTRAL VRS NETWORK AND DIRECTLY TIED TO BASE STATION HCPC g1012.
2. ALL ELEVATIONS ARE BASED ON NORTH AMERICAM VERTICAL DATUM OF 1988 (NAVD 88)(ADJUSTMENT OF 1991). ELEVATIONS WERE DERIVED BY GPS OBS (RTN) AND VERTICALLY CONSTRAINED TO NGS MONUMENT PID AW0613, STAMPED 145+87.45 (USACE), ELEVATION 14.92'.
3. FIELD SURVEYING WAS PERFORMED IN AUGUST 2018.
4. THE UNIT OF MEASURE IS U.S. SURVEY FEET.

DANNENBAUM
ENGINEERING CORPORATION
T.B.P.E. FIRM REGISTRATION #392
3100 WEST ALABAMA HOUSTON, TX 77098 (713) 520-9570

PREPARED BY:

DANNENBAUM ENGINEERING CORP.
TBPE FIRM REGISTRATION NO. 392

Donald A. Stephanik
DONALD A. STEPHANIK, P.E.
PROJECT MANAGER

DATE: 1/27/2021



GENERAL NOTES:

GENERAL:

NOTIFY THE ENGINEER IMMEDIATELY IF DISCREPANCIES ARE DISCOVERED IN THE HORIZONTAL CONTROL OR THE BENCHMARK DATA.

REFERENCES TO MANUFACTURER'S TRADE NAME OR CATALOG NUMBERS ARE FOR THE PURPOSE OF IDENTIFICATION ONLY. SIMILAR MATERIALS FROM OTHER MANUFACTURERS ARE PERMITTED IF THEY ARE OF EQUAL QUALITY, COMPLY WITH THE SPECIFICATIONS FOR THIS PROJECT, AND ARE APPROVED, EXCEPT FOR ROADWAY ILLUMINATION, ELECTRICAL, AND TRAFFIC SIGNAL ITEMS.

CLEARLY MARK OR HIGHLIGHT ON THE SHOP DRAWINGS, THE ITEMS BEING FURNISHED FOR THIS PROJECT. SUBMIT REQUIRED SHOP DRAWINGS IN ACCORDANCE WITH THE SHOP DRAWING DISTRIBUTION LIST SHOWN IN THE NOTE FOR ITEM 5 FOR REVIEW AND DISTRIBUTION.

UNLESS OTHERWISE SHOWN ON THE PLANS OR OTHERWISE DIRECTED, COMMENCE WORK AFTER SUNRISE AND ENSURE CONSTRUCTION EQUIPMENT IS OFF THE ROAD BY SUNSET.

PROCURE PERMITS AND LICENSES, WHICH ARE TO BE ISSUED BY THE CITY, COUNTY, OR MUNICIPAL UTILITY DISTRICT.

DUE TO THE CLOSE PROXIMITY TO SCHOLES INTERNATIONAL AIRPORT, ALL EQUIPMENT THAT EXTENDS 35 FEET AND ABOVE THE GROUND SHALL BE EQUIPPED WITH AN AVIATION ORANGE AND WHITE CHECKERED FLAG OF A MINIMAL SIZE THREE FOOT BY THREE FOOT. THE FLAG SHALL BE ATTACHED TO THE HIGHEST POINT ON THE EQUIPMENT.

NO EQUIPMENT SHALL BE ALLOWED TO OPERATE ON THE EXISTING TOE PROTECTION. ALL PLACEMENT OF THE DERRICK STONE SHALL BE ACCOMPLISHED FROM THE ROADWAY ADJACENT TO THE SIDEWALK. ALL THE EQUIPMENT SHOULD BE RUBBER TIRE EQUIPMENT. NO TRACK EQUIPMENT OR VEHICLES ARE PERMITTED.

SITE MANAGEMENT

MARK STATIONS EVERY 100 FT. AND MAINTAIN THE MARKINGS FOR THE PROJECT DURATION. REMOVE THE STATION MARKINGS AT THE COMPLETION OF THE PROJECT. THIS WORK IS SUBSIDIARY TO THE VARIOUS BID ITEMS.

DO NOT MIX OR STORE MATERIALS, OR STORE OR REPAIR EQUIPMENT, ON TOP OF CONCRETE PAVEMENT UNLESS AUTHORIZED BY THE ENGINEER. PERMISSION WILL BE GRANTED TO STORE MATERIALS ON SURFACES IF NO DAMAGE OR DISCOLORATION WILL RESULT.

PERSONAL VEHICLES OF EMPLOYEES ARE NOT PERMITTED TO PARK WITHIN THE RIGHT OF WAY, INCLUDING SECTIONS CLOSED TO PUBLIC TRAFFIC. EMPLOYEES

MAY PARK ON THE RIGHT OF WAY AT THE CONTRACTOR'S OFFICE, EQUIPMENT, AND MATERIALS STORAGE YARD SITES.

ASSUME OWNERSHIP OF DEBRIS AND DISPOSE OF AT AN APPROVED LOCATION. DO NOT DISPOSE OF DEBRIS ON PRIVATE PROPERTY UNLESS APPROVED IN WRITING BY THE ENGINEER.

TRAFFIC CONTROL AND CONSTRUCTION

WHEN DESIGN DETAILS ARE NOT SHOWN ON THE PLANS, PROVIDE SIGNS AND ARROWS CONFORMING TO THE LATEST "STANDARD HIGHWAY SIGN DESIGNS FOR TEXAS" MANUAL.

UTILITIES

CONSIDER THE LOCATIONS OF UNDERGROUND UTILITIES DEPICTED IN THE PLANS AS APPROXIMATE AND EMPLOY RESPONSIBLE CARE TO AVOID DAMAGING UTILITY FACILITIES. DEPENDING UPON SCOPE AND MAGNITUDE OF PLANNED CONSTRUCTION ACTIVITIES, ADVANCED FIELD CONFIRMATION BY THE UTILITY OWNER OR OPERATOR MAY BE PRUDENT. WHERE POSSIBLE, PROTECT AND PRESERVE PERMANENT SIGNS, MARKERS, AND DESIGNATIONS OF UNDERGROUND FACILITIES.

IF THE CONTRACTOR DAMAGES OR CAUSES DAMAGE (BREAKS, LEAKS, NICKS, DENTS, GOUGES, ETC.) TO THE UTILITY, CONTACT THE UTILITY FACILITY OWNER OR OPERATOR IMMEDIATELY.

IF WORKING NEAR POWER LINES, COMPLY WITH THE APPROPRIATE SECTIONS OF TEXAS STATE LAW AND FEDERAL REGULATIONS RELATING TO THE TYPE OF WORK INVOLVED.

CONTROL OF WORK

NO PART OF THE CRANE INCLUDING OUTRIGGERS SHALL BE PLACE ON THE EXISTING SIDEWALK. ONLY A RUBBER-TIRED CRANE WILL BE PERMITTED. THE CONTRACTOR SHALL PROVIDE ALL NECESSARY EQUIPMENT AND MATERIALS TO PROTECT THE EXISTING PAVEMENT FROM DAMAGE. NO ADDITIONAL COST WILL BE PAID FOR SUCH PAVEMENT PROTECTION. IT SHALL BE CONSIDERED INCIDENTAL TO THE PLACEMENT OF THE DERRICK STONE.

LEGAL RELATIONS AND RESPONSIBILITIES

THE PROJECT WORK FALLS UNDER THE MAINTENANCE AND REPAIR SECTION OF THE PERMIT ASSOCIATED WITH THE U.S. ARMY CORPS OF ENGINEERS (USACE) PERMIT AREA. THEREFORE, NO ADDITIONAL PERMITS ARE REQUIRED.

THIS PROJECT IS ON A HURRICANE EVACUATION ROUTE. PROVIDE AT THE PRE-CONSTRUCTION MEETING A WRITTEN PLAN OUTLINING PROCEDURES TO SUSPEND WORK, SECURE THE JOB SITE, AND SAFELY HANDLE TRAFFIC THROUGH AND ACROSS THE PROJECT IN THE EVENT OF A HURRICANE EVACUATION.

DURING THE HURRICANE SEASON (JUNE 1 THROUGH NOVEMBER 30), DO NOT CLOSE ANY TRAVEL LANES EXCEPT WHEN THE CONTRACTOR CAN DEMONSTRATE THAT HE/SHE CAN PROVIDE LABOR, EQUIPMENT, MATERIAL, A WORK PLAN, AND QUALITY OF WORK TO SATISFACTORILY RETURN ALL LANES TO AN OPEN, ALL-WEATHER TRAVEL SURFACE WITHIN 3 DAYS OF RECEIVING WRITTEN OR VERBAL NOTICE BUT NO LATER THAN 3 DAYS BEFORE THE PREDICTED HURRICANE LANDFALL.

IN ADDITION TO LANE CLOSURES, CEASE WORK 3 DAYS BEFORE THE PREDICTED HURRICANE LANDFALL ON OR NEAR THE ROADWAY THAT ADVERSELY IMPACTS THE FLOW OF TRAFFIC AND REDUCES THE CAPACITY OF THE HIGHWAY DURING AN EVACUATION. VEHICLES OF THE CONTRACTOR, SUBCONTRACTORS, OR MATERIAL SUPPLIERS WILL NOT BE ALLOWED TO ENTER OR EXIT THE TRAFFIC STREAM, INCLUDING THOSE FOR THE PURPOSE OF MATERIAL HAULING AND DELIVERY, AND MOBILIZATION OR DEMOBILIZATION OF EQUIPMENT. WHEN DIRECTED, THIS PROHIBITION WILL INCLUDE A REASONABLE TIME PERIOD FOR THE EVACUEES TO RETURN TO THEIR POINT OF ORIGIN.

NO SIGNIFICANT TRAFFIC GENERATOR EVENTS HAVE BEEN IDENTIFIED.

PROSECUTION AND PROGRESS

CREATE, MAINTAIN, AND SUBMIT FOR APPROVAL, A CRITICAL PATH METHOD (CPM) PROJECT SCHEDULE USING COMPUTER SOFTWARE THAT IS FULLY COMPATIBLE WITH THE LATEST VERSION OF PRIMAVERA SYSTEMS, INC. OR PRIMAVERA PROJECT PLANNER (P3 OR P6).

THE COUNTY WILL NOT ADJUST THE NUMBER OF DAYS FOR THE PROJECT AND MILESTONES, IF ANY, DUE TO DIFFERENCES IN OPINION REGARDING ANY ASSUMPTIONS MADE IN THE PREPARATION OF THE SCHEDULE OR FOR ERRORS, OMISSIONS, OR DISCREPANCIES FOUND IN THE TIME DETERMINATION SCHEDULE.

PROVIDE A VIRUS-FREE COMPUTER DISK OR OTHER ACCEPTABLE ELECTRONIC MEDIA CONTAINING THE PRIMAVERA CONSTRUCTION SCHEDULE.

THE ANTICIPATED CONSTRUCTION DURATION AFTER THE DERRICK STONES BEGIN TO ARRIVE AT THE PROJECT SITE IS 120 CALENDAR DAYS. THE CONSTRUCTION WILL BE LIMITED TO DAYLIGHT CONSTRUCTION ONLY.

BARRICADES, SIGNS, AND TRAFFIC HANDLING

USE A TRAFFIC CONTROL PLAN FOR HANDLING TRAFFIC THROUGH THE VARIOUS PHASES OF CONSTRUCTION. FOLLOW THE PHASING SEQUENCE UNLESS OTHERWISE AGREED UPON BY THE ENGINEER AND THE PROJECT MANAGER. ENSURE THIS PLAN CONFORMS TO THE LATEST "TEXAS MANUAL ON UNIFORM TRAFFIC CONTROL DEVICES" AND THE LATEST BARRICADE AND CONSTRUCTION (BC) STANDARD SHEETS. THE LATEST VERSIONS OF WORK ZONE STANDARD SHEETS WZ (BTS-1) AND WZ (BTS-2) ARE THE TRAFFIC CONTROL PLAN FOR THE SIGNAL INSTALLATIONS.

SUBMIT CHANGES TO THE TRAFFIC CONTROL PLAN TO THE ENGINEER. PROVIDE A LAYOUT SHOWING THE CONSTRUCTION PHASING, SIGNS, STRIPING, AND SIGNALIZATIONS FOR CHANGES TO THE ORIGINAL TRAFFIC CONTROL PLAN.

FURNISH AND MAINTAIN THE BARRICADES AND WARNING SIGNS, INCLUDING THE NECESSARY TEMPORARY AND PORTABLE TRAFFIC CONTROL DEVICES, DURING THE VARIOUS PHASES OF CONSTRUCTION. PLACE AND CONSTRUCT THESE BARRICADES AND WARNING SIGNS IN ACCORDANCE WITH THE LATEST "TEXAS MANUAL ON UNIFORM TRAFFIC CONTROL DEVICES" FOR TYPICAL CONSTRUCTION LAYOUTS.

COVER WORK ZONE SIGNS WHEN WORK RELATED TO THE SIGNS IS NOT IN PROGRESS, OR WHEN ANY HAZARD RELATED TO THE SIGNS NO LONGER EXISTS.

KEEP THE DELINEATION DEVICES, SIGNS, AND PAVEMENT MARKINGS CLEAN. THIS WORK IS SUBSIDIARY TO THE ITEM, "BARRICADES, SIGNS, AND TRAFFIC HANDLING."

COVER OR REMOVE THE PERMANENT SIGNS AND CONSTRUCTION SIGNS THAT ARE INCORRECT OR THAT DO NOT APPLY TO THE CURRENT SITUATION FOR A PARTICULAR PHASE.

DO NOT MOUNT SIGNS ON DRUMS OR BARRICADES, EXCEPT THOSE LISTED IN THE LATEST BARRICADES AND CONSTRUCTION STANDARD SHEETS.

USE TRAFFIC CONES FOR DAYTIME WORK ONLY. REPLACE THE CONES WITH PLASTIC DRUMS DURING NIGHTTIME HOURS.

A MINIMUM OF 7 DAYS IN ADVANCE OF ANY TOTAL CLOSURE, PLACE A PORTABLE CHANGEABLE MESSAGE (PCM) SIGN AT THE LOCATION OF EACH TOTAL CLOSURE WHICH INFORMS THE TRAVELING PUBLIC OF THE DETAILS OF THE CLOSURE. ALTERNATELY, IF THE TRAFFIC CONTROL PLAN PROVIDES A POSITIVE BARRIER AT THE LOCATION, A NON-TRAILER MOUNTED STATIC MESSAGE BOARD SIGN BEHIND THE POSITIVE BARRIER MAY BE USED IN PLACE OF A PCM.

TEMPORARY EROSION, SEDIMENTATION AND ENVIRONMENTAL CONTROLS

DUE TO THE NATURE OF THE WORK INVOLVED, A STORM WATER POLLUTION PREVENTION PLAN (SWP3) IS NOT REQUIRED. HOWEVER, IF A SWP3 BECOMES NECESSARY, IT WILL BE PAID AS EXTRA WORK.

THE STORM WATER POLLUTION PREVENTION PLAN (SWP3) CONSISTS OF TEMPORARY EROSION CONTROL MEASURES NEEDED AND PROVIDED FOR UNDER THIS ITEM. THE DISTURBED AREA IS LESS THAN ONE ACRE AND USE OF EROSION CONTROL MEASURES IS NOT ANTICIPATED. IF PHYSICAL CONDITIONS ENCOUNTERED AT THE JOB SITE REQUIRE NECESSARY CONTROLS, BMP INSTALLATION, MAINTENANCE, AND REMOVAL WILL BE PAID AS EXTRA WORK ON A FORCE ACCOUNT BASIS PER ARTICLES 4.4 AND 9.7. SINCE THE DISTURBED AREA IS LESS THAN 5 ACRES, A "NOTICE OF INTENT" (NOI) IS NOT REQUIRED.

WORK ZONE PAVEMENT MARKINGS

AT THE END OF EACH WORKDAY, MARK ROADWAYS THAT REMAIN OPEN TO TRAFFIC DURING CONSTRUCTION OPERATIONS WITH STANDARD PAVEMENT MARKINGS, IN ACCORDANCE WITH THE LATEST "TEXAS MANUAL ON UNIFORM TRAFFIC CONTROL DEVICES."

CLEANING AND SWEEPING HIGHWAYS

THE CONTRACTOR SHALL CLEAN AND SWEEP THE HIGHWAY AND PARKING AREA UPON COMPLETION OF THE PLACEMENT OF THE DERRICK STONE AND PROJECT ACTIVITIES. THIS WORK WILL BE CONSIDERED INCIDENTAL TO THE MOBILIZATION/DEMOBILIZATION PAY ITEM.

Contract Line Item (CLIN)	TxDOT 2014	Item Description	Unit	Unit Quantity
GENERAL				
0001	500	Mobilization	LS	1
0002	502	Barricades, Signs, and Traffic Handling	MONTH	4
0003		Constructing Detours	LS	1
0004		Project Sign	EA	1
EROSION CONTROL				
0005		Furnish and Install Granite Derrick Stone	EA	2,095

NOT TO SCALE

REV. NO.	DATE	DESCRIPTION	BY



DANNENBAUM
ENGINEERING CORPORATION
T.B.P.E. FIRM REGISTRATION #392
3100 WEST ALABAMA HOUSTON, TX 77098 (713) 520-9570

GALVESTON SEAWALL RIP RAP DEFICIENCIES WEST OF 61st STREET

GENERAL NOTES AND QUANTITIES

SHEET 2 OF 39

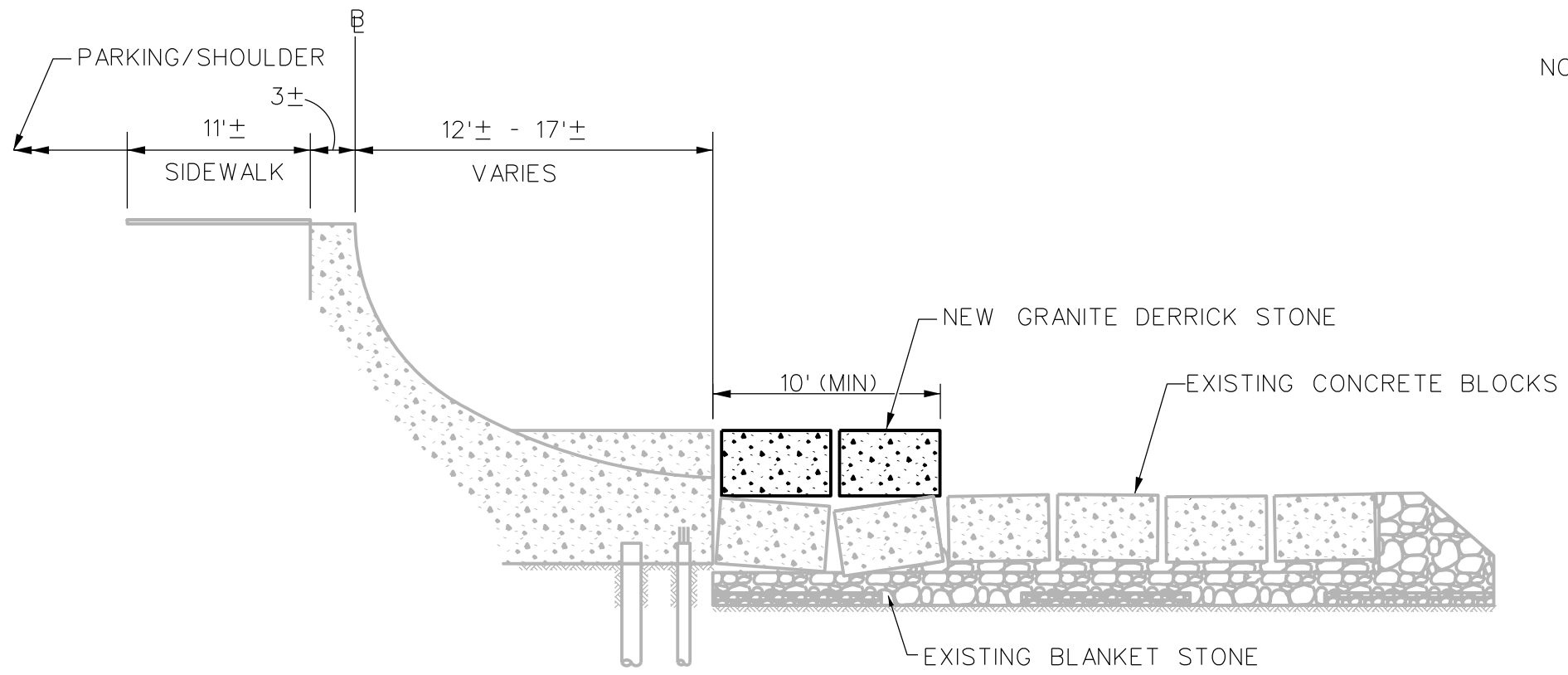

NOTES:
 1) ACTUAL FIELD CONDITIONS MAY VARY SLIGHTLY
 THE INTENT IS TO PLACE THE DERRICK STONE
 AS CLOSE TO THE TYPICALS SHOWN TO PROVIDE
 TOE PROTECTION OF THE SEAWALL.

(A) PROPOSED TYPICAL SECTION
 10-FOOT-WIDE TOE PROTECTION

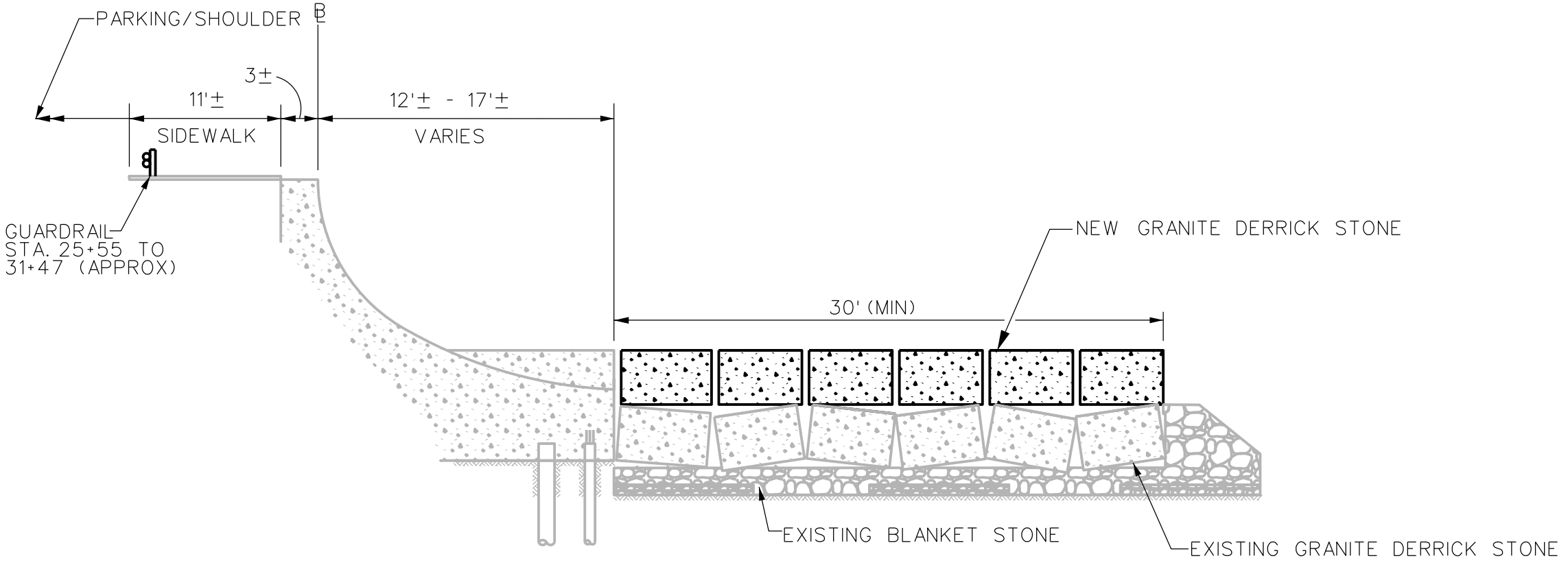

(B) PROPOSED TYPICAL SECTION
 30-FOOT-WIDE TOE PROTECTION

NOT TO SCALE

REV. NO.	DATE	DESCRIPTION	BY



DANNENBAUM
 ENGINEERING CORPORATION
 T.B.P.E. FIRM REGISTRATION #392
 3100 WEST ALABAMA HOUSTON, TX 77098 (713) 520-9570

GALVESTON SEAWALL RIP RAP
 DEFICIENCIES WEST OF 61st STREET

TYPICAL SECTION TOE
 PROTECTION

SHEET 3 OF 39

SHEET
 NO.
 3

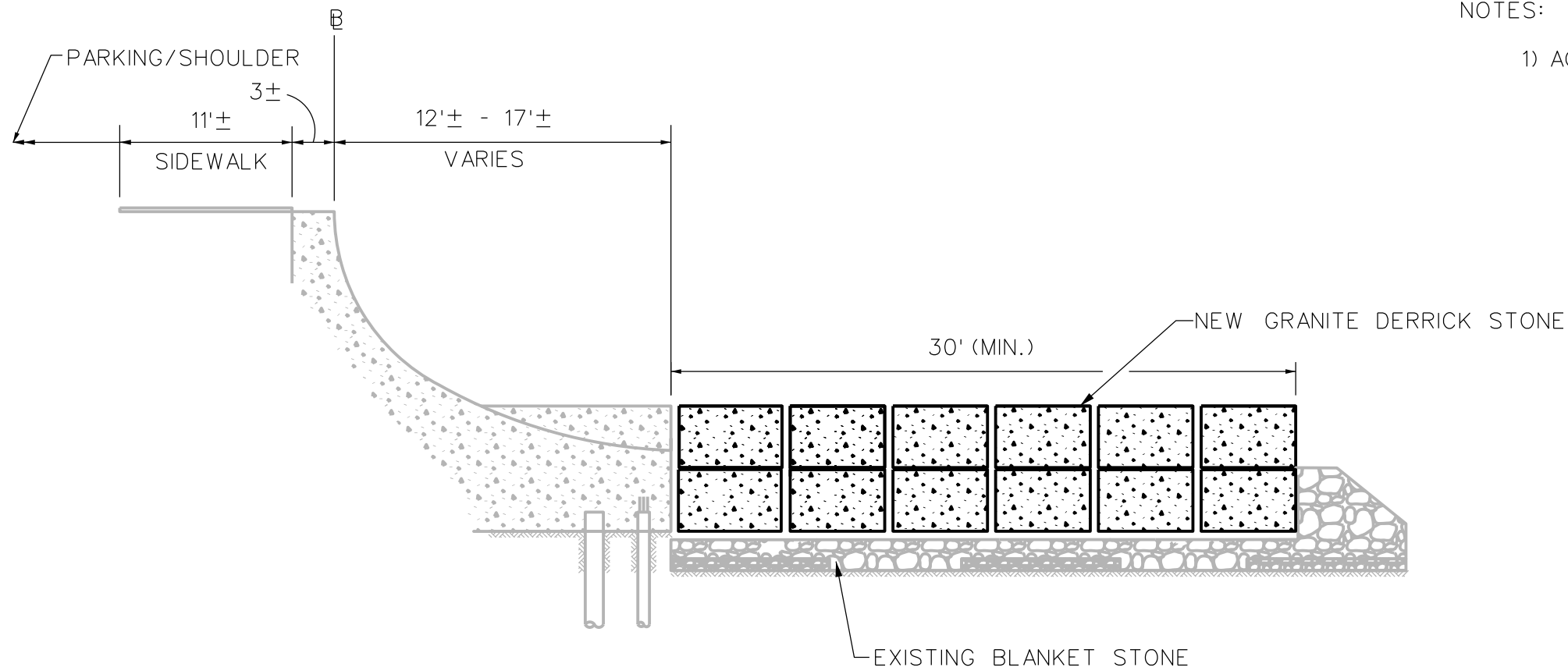

NOTES:

- 1) ACTUAL FIELD CONDITIONS MAY VARY SLIGHTLY THE INTENT IS TO PLACE THE DERRICK STONE AS CLOSE TO THE TYPICALS SHOWN TO PROVIDE TOE PROTECTION OF THE SEAWALL.

Ⓒ PROPOSED TYPICAL SECTION
DOUBLE STACK STONE AREA

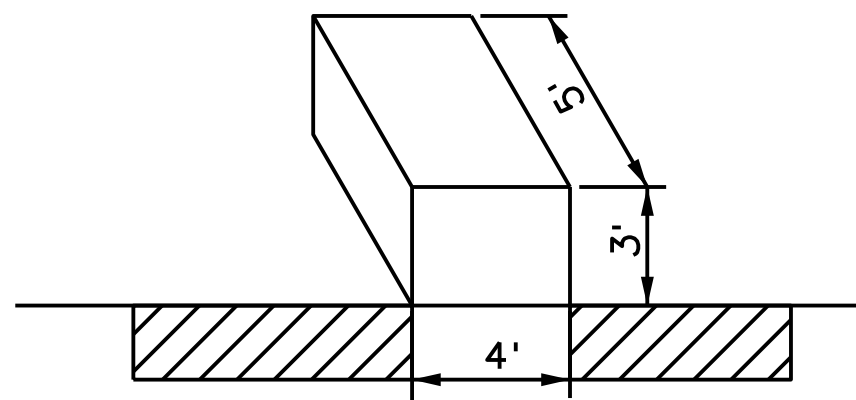

GRANITE DERRICK STONE
NOT TO SCALE

NOT TO SCALE

REV. NO.	DATE	DESCRIPTION	BY



DANNENBAUM
ENGINEERING CORPORATION
T.B.P.E. FIRM REGISTRATION #392
3100 WEST ALABAMA HOUSTON, TX 77098 (713) 520-9570

GALVESTON SEAWALL RIP RAP DEFICIENCIES WEST OF 61st STREET

TYPICAL SECTION TOE PROTECTION

SHEET 4 OF 39

LEGEND



NOTES:

1) DO NOT CUT DERRICK STONE
TO FIT INTO STATION LIMITS.

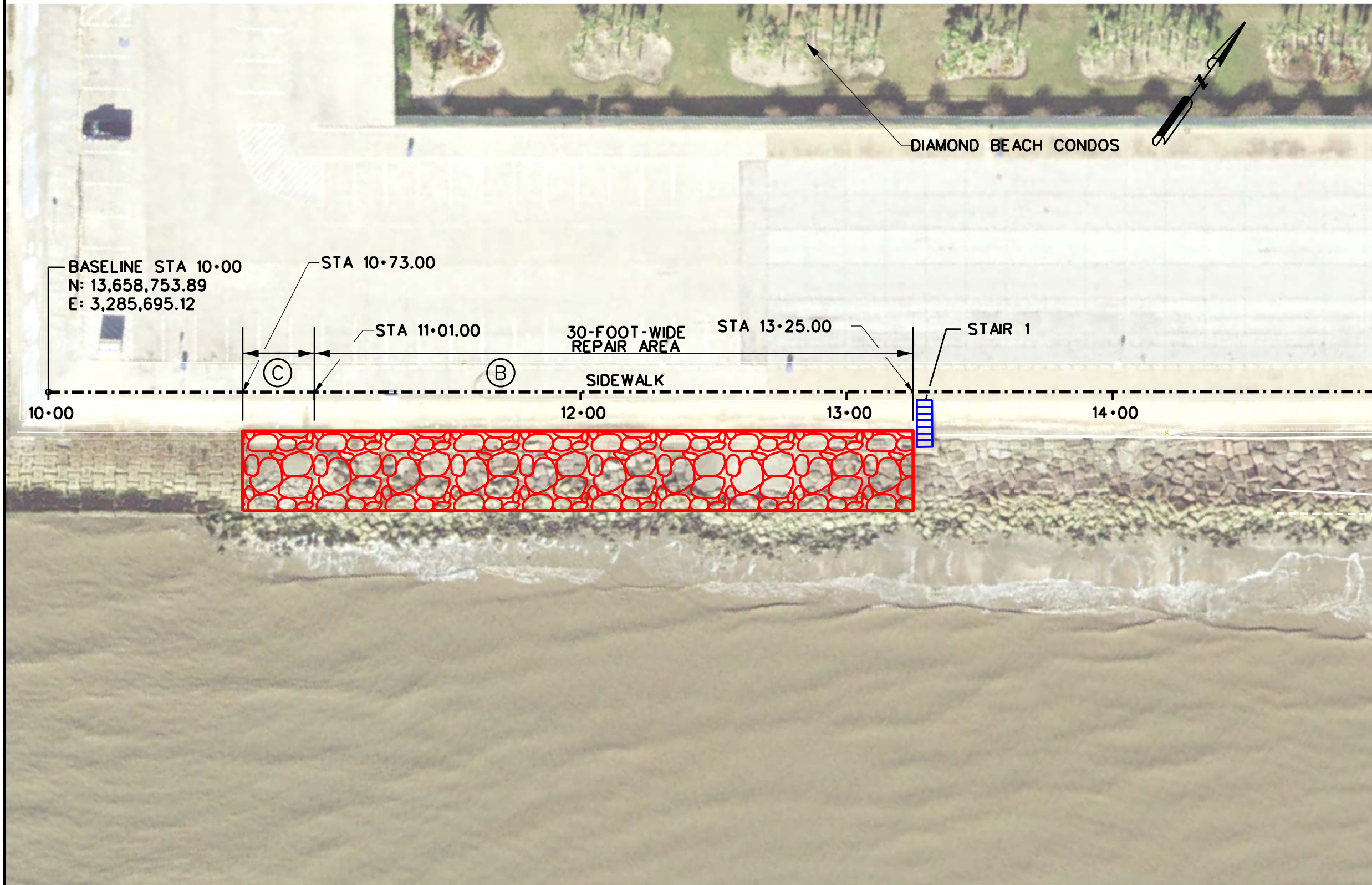

MATCH LINE STA 15+00

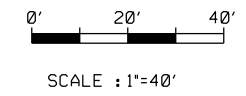

REV. NO.	DATE	DESCRIPTION	BY



DANNENBAUM
ENGINEERING CORPORATION
T.B.P.E. FIRM REGISTRATION #392
3100 WEST ALABAMA HOUSTON, TX 77098 (713) 520-6570

**GALVESTON SEAWALL RIP RAP
DEFICIENCIES WEST OF 61st STREET
PLAN VIEW**

SHEET 5 OF 39

SHEET NO.
5

LEGEND

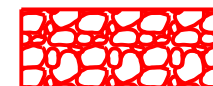

GRANITE DERRICK STONE
PLACEMENT AREA



TYPICAL SECTION
REFERENCE

NOTES:

1) DO NOT CUT DERRICK STONE
TO FIT INTO STATION LIMITS.

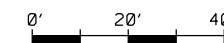

SCALE : 1"=40'

REV. NO.	DATE	DESCRIPTION	BY



DANNENBAUM

ENGINEERING CORPORATION
T.B.P.E. FIRM REGISTRATION #392
3100 WEST ALABAMA HOUSTON, TX 77098 (713) 520-6570

GALVESTON SEAWALL RIP RAP
DEFICIENCIES WEST OF 61st STREET

PLAN VIEW

SHEET 6 OF 39

SHEET
NO.
6

MATCH LINE STA 15+00

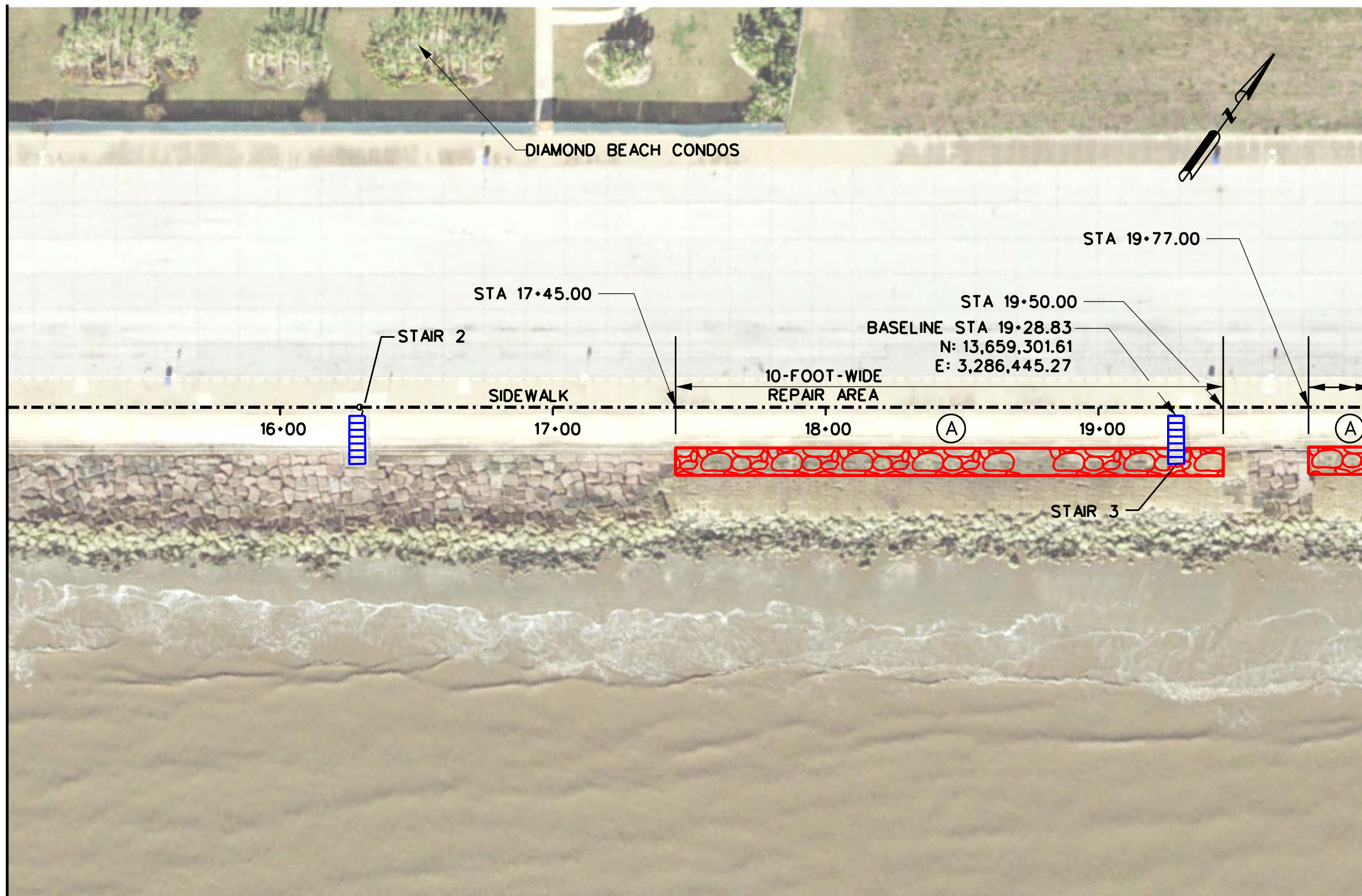

MATCH LINE STA 20+00

LEGEND

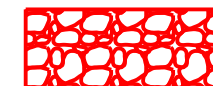

GRANITE DERRICK STONE
PLACEMENT AREA



TYPICAL SECTION
REFERENCE

NOTES:

1) DO NOT CUT DERRICK STONE
TO FIT INTO STATION LIMITS.

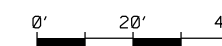

SCALE : 1"=40'

REV. NO.	DATE	DESCRIPTION	BY



DANNENBAUM

ENGINEERING CORPORATION
T.B.P.E. FIRM REGISTRATION #392
3100 WEST ALABAMA HOUSTON, TX 77098 (713) 520-6570

GALVESTON SEAWALL RIP RAP
DEFICIENCIES WEST OF 61st STREET

PLAN VIEW

SHEET 7 OF 39

SHEET
NO.
7

MATCH LINE STA 20+00

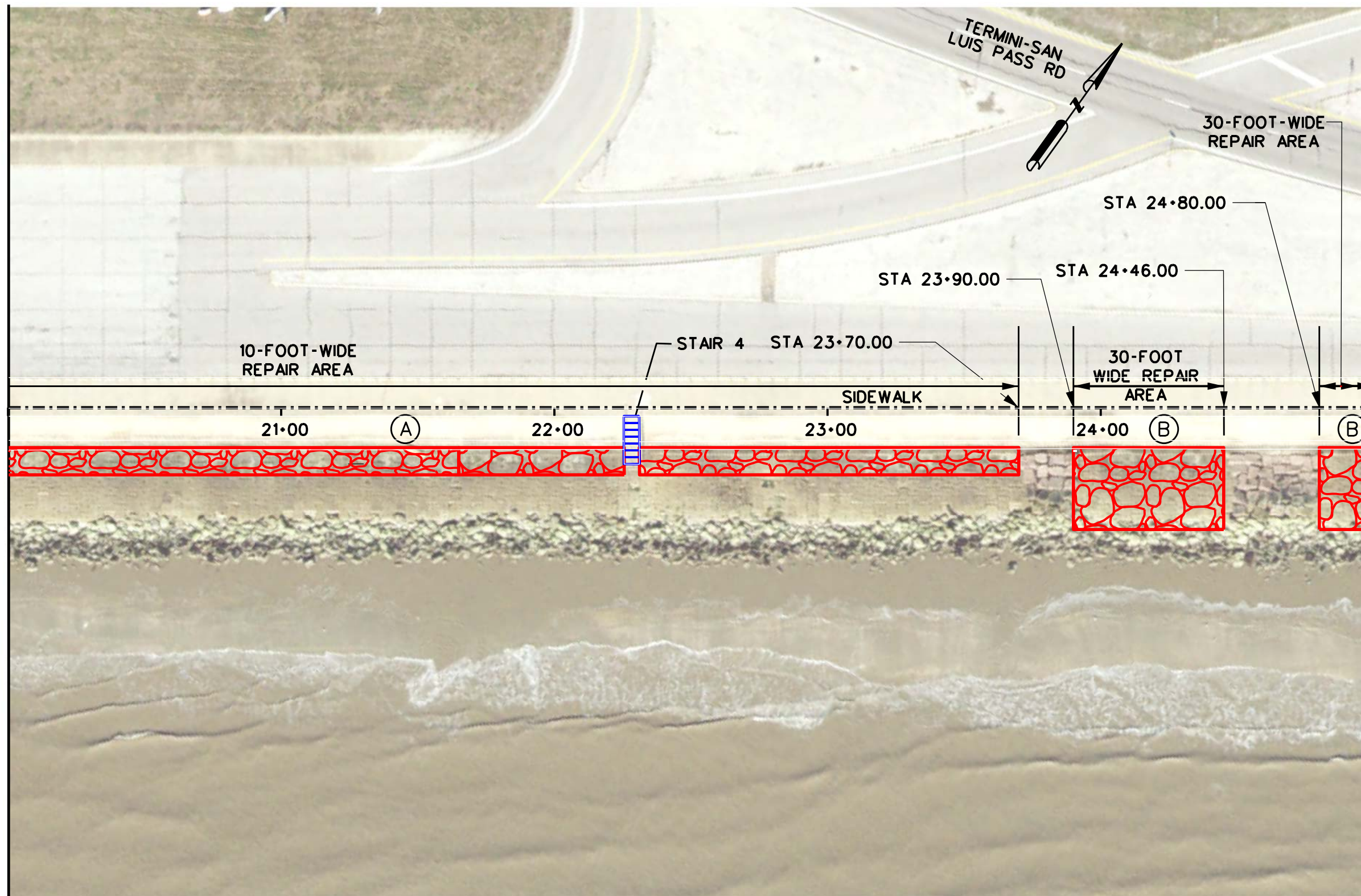

MATCH LINE STA 25+00

LEGEND

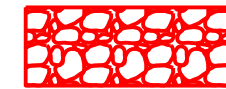

GRANITE DERRICK STONE
PLACEMENT AREA



TYPICAL SECTION
REFERENCE

NOTES:

1) DO NOT CUT DERRICK STONE
TO FIT INTO STATION LIMITS.



SCALE : 1"=40'

REV. NO.	DATE	DESCRIPTION	BY



DANNENBAUM

ENGINEERING CORPORATION
T.B.P.E. FIRM REGISTRATION #392
3100 WEST ALABAMA HOUSTON, TX 77098 (713) 520-6570

GALVESTON SEAWALL RIP RAP
DEFICIENCIES WEST OF 61st STREET

PLAN VIEW

SHEET 8 OF 39

SHEET
NO.
8

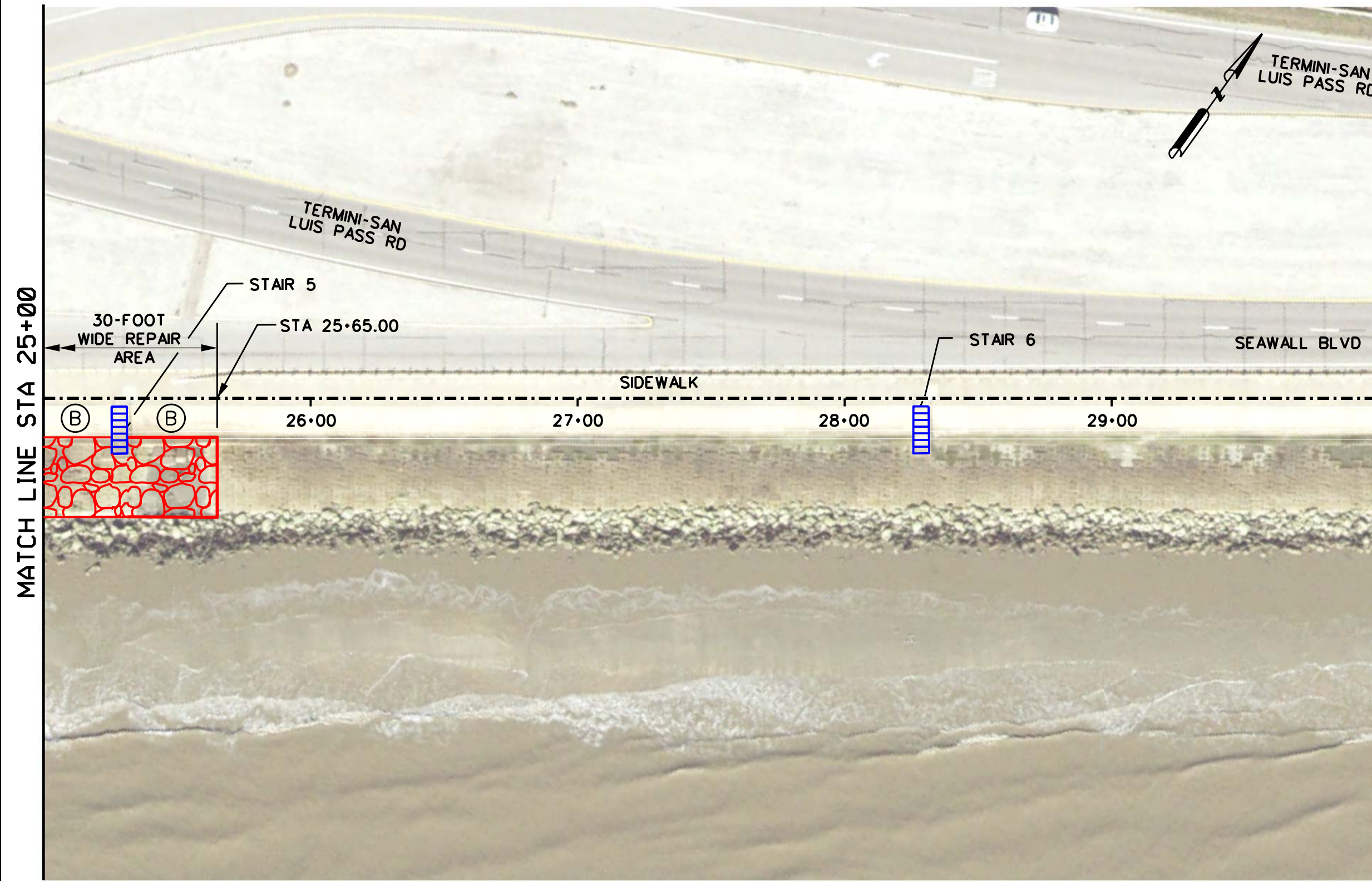

MATCH LINE STA 25+00

MATCH LINE STA 30+00

LEGEND

 GRANITE DERRICK STONE PLACEMENT AREA

 TYPICAL SECTION REFERENCE

NOTES:

1) DO NOT CUT DERRICK STONE TO FIT INTO STATION LIMITS.

0' 20' 40'
SCALE : 1"=40'

MATCH LINE STA 30+00

MATCH LINE STA 35+00



REV. NO.	DATE	DESCRIPTION	BY



DANNENBAUM

ENGINEERING CORPORATION
T.B.P.E. FIRM REGISTRATION #392
3100 WEST ALABAMA HOUSTON, TX 77098 (713) 520-6570

GALVESTON SEAWALL RIP RAP DEFICIENCIES WEST OF 61st STREET

PLAN VIEW

SHEET 9 OF 39

SHEET NO. 9

LEGEND

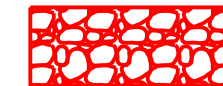

GRANITE DERRICK STONE
PLACEMENT AREA



TYPICAL SECTION
REFERENCE

NOTES:

1) DO NOT CUT DERRICK STONE
TO FIT INTO STATION LIMITS.

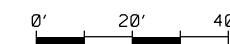

SCALE : 1"=40'

REV. NO.	DATE	DESCRIPTION	BY



DANNENBAUM

ENGINEERING CORPORATION
T.B.P.E. FIRM REGISTRATION #392
3100 WEST ALABAMA HOUSTON, TX 77098 (713) 520-0570

**GALVESTON SEAWALL RIP RAP
DEFICIENCIES WEST OF 61st STREET**

PLAN VIEW

SHEET 10 OF 39

SHEET
NO.
10

MATCH LINE STA 35+00

MATCH LINE STA 40+00

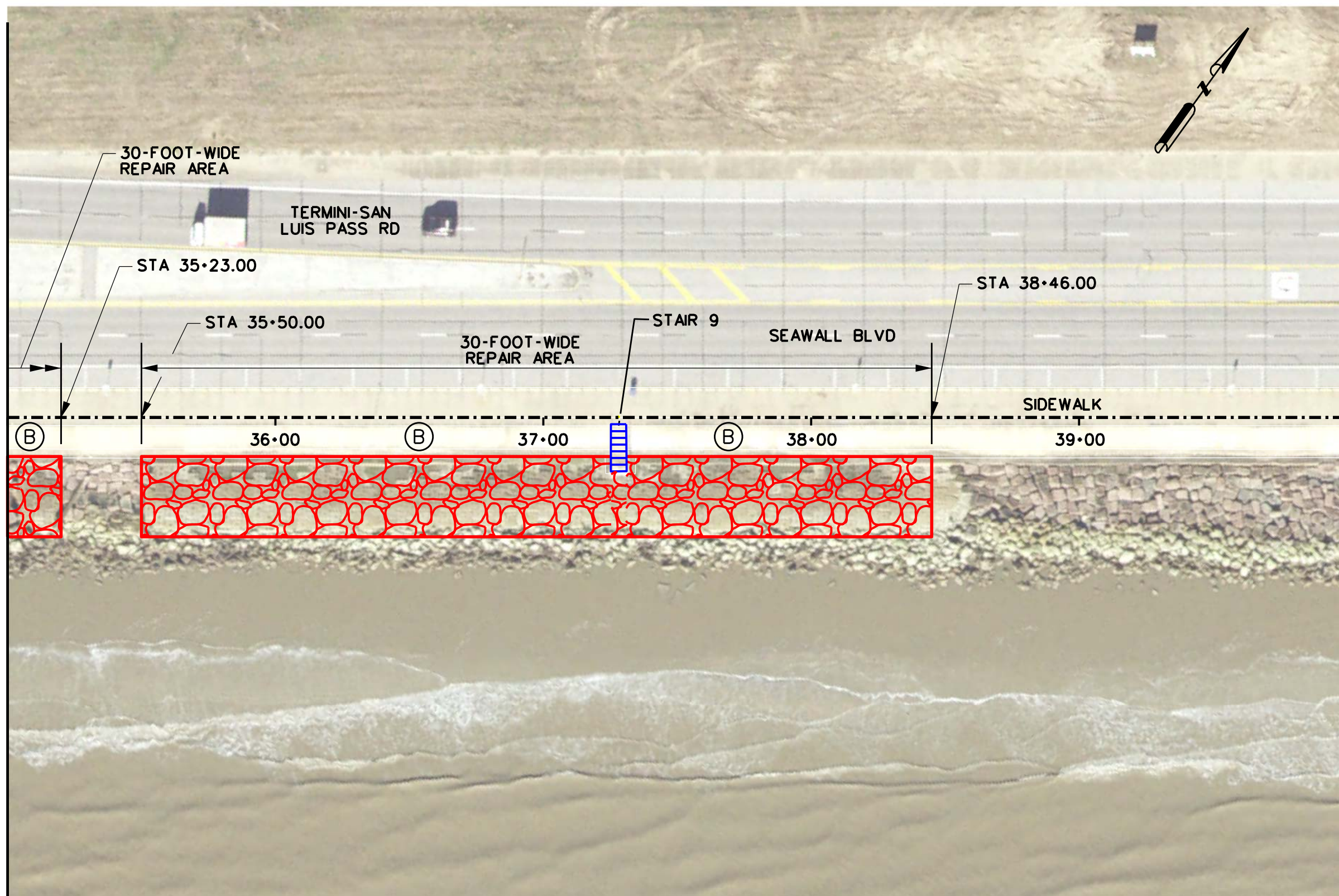

30-FOOT-WIDE
REPAIR AREA

TERMINI-SAN
LUIS PASS RD

STA 35+23.00

STA 35+50.00

30-FOOT-WIDE
REPAIR AREA

STAIR 9

SEAWALL BLVD

STA 38+46.00

SIDEWALK

36+00

37+00

38+00

39+00

(B)

(B)

(B)

LEGEND

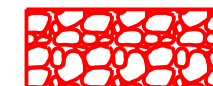

GRANITE DERRICK STONE
PLACEMENT AREA



TYPICAL SECTION
REFERENCE

NOTES:

1) DO NOT CUT DERRICK STONE
TO FIT INTO STATION LIMITS.

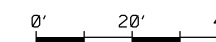

SCALE : 1"=40'

REV. NO.	DATE	DESCRIPTION	BY



DANNENBAUM

ENGINEERING CORPORATION
T.B.P.E. FIRM REGISTRATION #392
3100 WEST ALABAMA HOUSTON, TX 77098 (713) 520-6570

GALVESTON SEAWALL RIP RAP
DEFICIENCIES WEST OF 61st STREET

PLAN VIEW

SHEET 11 OF 39

SHEET
NO.
11

MATCH LINE STA 40+00

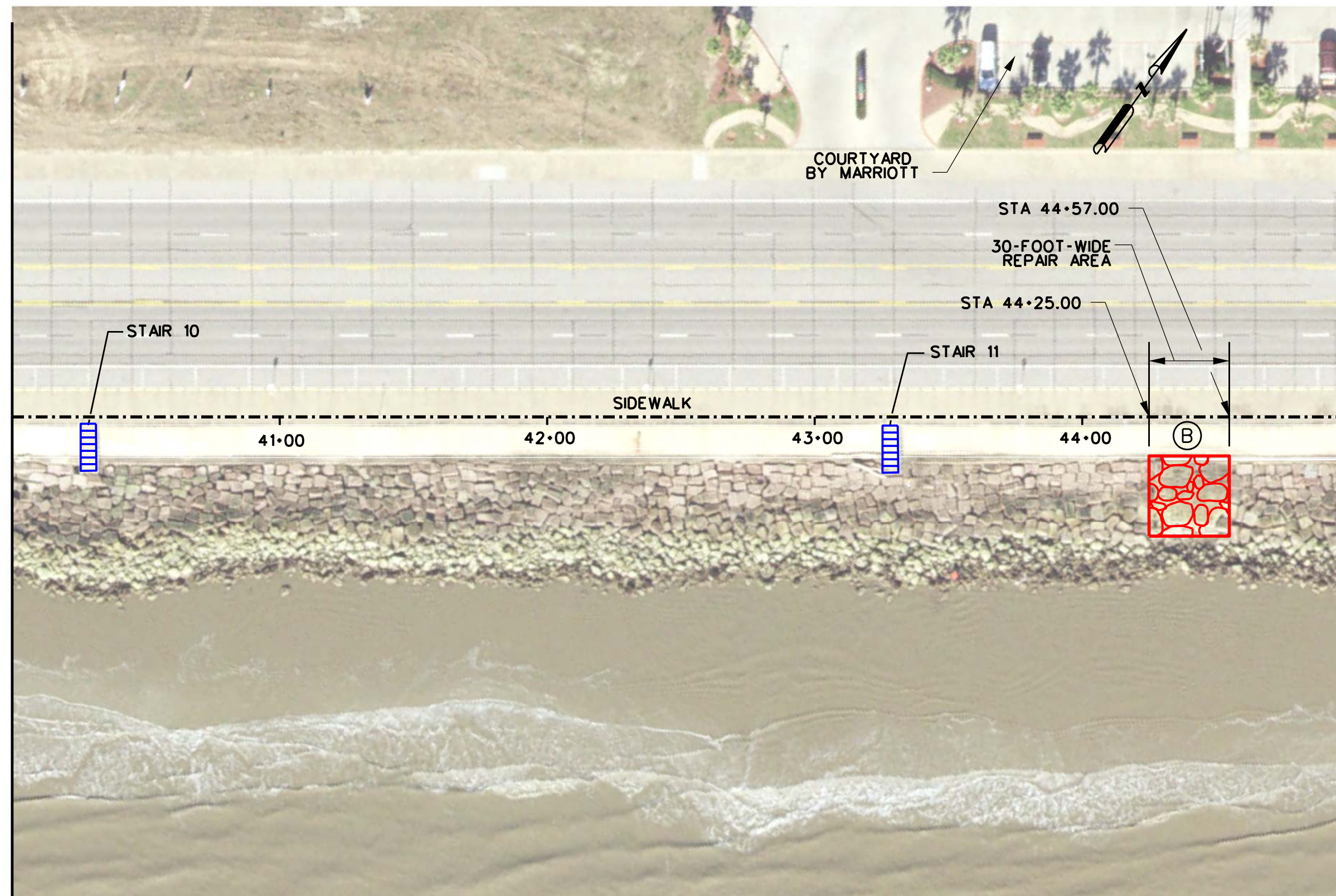

MATCH LINE STA 45+00

LEGEND

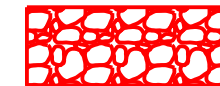

GRANITE DERRICK STONE
PLACEMENT AREA



TYPICAL SECTION
REFERENCE

NOTES:

1) DO NOT CUT DERRICK STONE
TO FIT INTO STATION LIMITS.

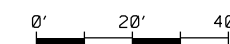

SCALE : 1"=40'

REV. NO.	DATE	DESCRIPTION	BY



DANNENBAUM

ENGINEERING CORPORATION
T.B.P.E. FIRM REGISTRATION #392
3100 WEST ALABAMA HOUSTON, TX 77098 (713) 520-6570

GALVESTON SEAWALL RIP RAP
DEFICIENCIES WEST OF 61st STREET

PLAN VIEW

SHEET 12 OF 39

SHEET
NO.
12

MATCH LINE STA 45+00

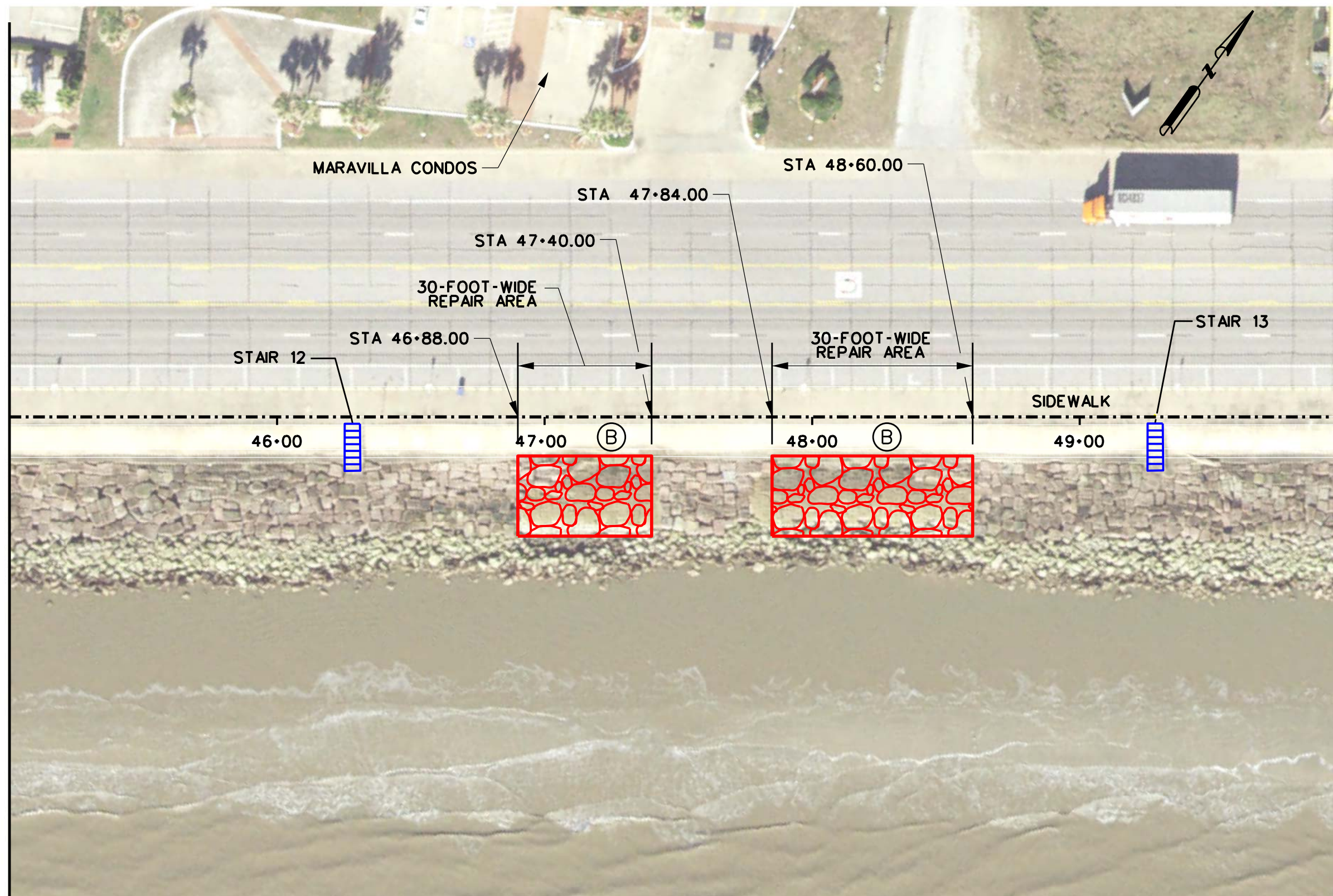

MATCH LINE STA 50+00

LEGEND

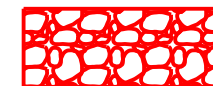

GRANITE DERRICK STONE
PLACEMENT AREA



TYPICAL SECTION
REFERENCE

NOTES:

1) DO NOT CUT DERRICK STONE
TO FIT INTO STATION LIMITS.

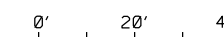

SCALE : 1"=40'

REV. NO.	DATE	DESCRIPTION	BY



DANNENBAUM

ENGINEERING CORPORATION
T.B.P.E. FIRM REGISTRATION #392
3100 WEST ALABAMA HOUSTON, TX 77098 (713) 520-6570

GALVESTON SEAWALL RIP RAP
DEFICIENCIES WEST OF 61st STREET

PLAN VIEW

SHEET 13 OF 39

SHEET
NO.
13

MATCH LINE STA 50+00

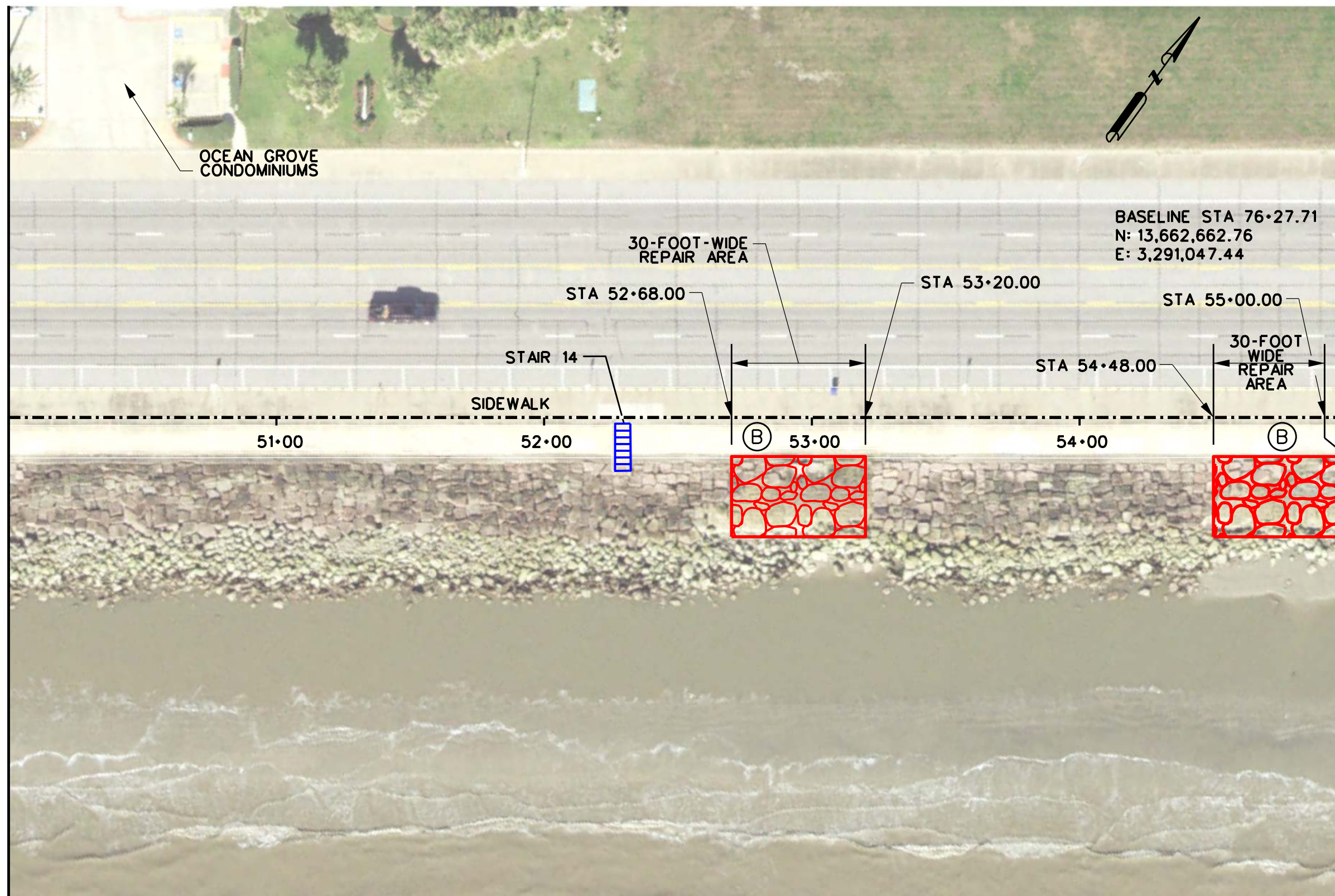

OCEAN GROVE
CONDOMINIUMS

BASELINE STA 76+27.71
N: 13,662,662.76
E: 3,291,047.44

30-FOOT-WIDE
REPAIR AREA

STA 52+68.00

STA 53+20.00

STA 55+00.00

STAIR 14

SIDEWALK

STA 54+48.00

30-FOOT
WIDE
REPAIR
AREA

51+00

52+00

(B)

53+00

54+00

(B)

GENERAL MAINTENANCE AND PROTECTION OF TRAFFIC NOTES.

1. ALL TRAFFIC CONTROL DEVICES SHALL BE IN ACCORDANCE TO TXDOT STANDARD DRAWINGS AND SPECIFICATIONS.
2. ANY MAINTENANCE OF TRAFFIC ITEM NOT SPECIFICALLY CALLED OUT AS A PAY ITEM, SHALL BE CONSIDERED INCIDENTAL TO PAY ITEM NO. 2, TXDOT ITEM 502 BARRICADES, SIGNS, AND TRAFFIC HANDLING.
3. THE CONTRACTOR IS TO MAINTAIN ALL TRAFFIC CONTROL DEVICES THROUGHOUT THE DURATION OF THE PROJECT TO PROVIDE A SAFE WORK ZONE FOR THE TRAVELING PUBLIC. THIS INCLUDES MONITORING THE CONTROL DEVICES FOR PROPER ALIGNMENT, PLACEMENT, WORKING ORDER AND REFLECTIVITY. ANY ITEM THAT IS DAMAGED, KNOCKED OUT OF ALIGNMENT, BLOWN OVER OR HAS ANY OTHER ISSUE THAT IS PROHIBITING IT FROM FUNCTIONING AS INTENDED, SHALL BE REPLACED OR REPOSITIONED IMMEDIATELY.
4. THE POSTED WORK ZONE SPEED LIMIT SHALL BE 35 MPH.
5. THE PORTABLE CHANGEABLE MESSAGE SIGN (PCMS) IN THE EASTBOUND DIRECTION SHOULD STATE "DETOUR AHEAD AND ONE LANE TRAFFIC". THE CITY, COUNTY OR STATE MAY REQUEST DIFFERENT OR ADDITIONAL MESSAGES.
6. THE PORTABLE CHANGEABLE MESSAGE SIGN (PCMS) IN THE WESTBOUND DIRECTION SHOULD STATE "LEFT LANE CLOSED AHEAD AND ONE LANE TRAFFIC". THE CITY, COUNTY OR STATE MAY REQUEST DIFFERENT OR ADDITIONAL MESSAGES.

PHASE I

PHASE 1A WILL INCLUDE CLOSING THE PARKING AREA TO THE PUBLIC FOR USE BY THE CONTRACTOR FOR THEIR STAGING AND STORAGE AREA. ONCE THE STAGING AND STORAGE AREA IS CLOSED, THE WORK SHALL COMMENCE ON PLACING THE DERRICK STONE FROM STATION 10+73 TO STATION 24+46. ALL TRAFFIC CONTROL DEVICES SHALL BE IN PLACE AS SHOWN IN THE PLANS PRIOR TO COMMENCING ANY CONSTRUCTION ACTIVITIES.

PHASE 1B WILL INCLUDE CLOSING THE LEFT LANE IN BOTH THE EASTBOUND AND WESTBOUND DIRECTION TO CONSTRUCT THE EASTBOUND TEMPORARY CROSS-OVER. ONE LANE OF TRAFFIC IN EACH DIRECTION SHALL REMAIN OPEN TO TRAFFIC AT ALL TIMES. ALL TRAFFIC CONTROL DEVICES SHALL BE IN PLACE AS SHOWN IN THE PLANS PRIOR TO COMMENCING ANY CONSTRUCTION ACTIVITIES.

PHASE 2

PHASE 2 SHALL REDUCE THE WESTBOUND LANES TO ONE LANE AND THEN REDIRECT EASTBOUND TRAFFIC TO THE TEMPORARY CROSS-OVER AND LIMIT THE WESTBOUND TRAFFIC TO ONE LANE. THE DERRICK STONE SHALL BE PLACES FROM STATION 24+80 TO STATION 55+00. ONCE ALL THE DERRICK STONE IS PLACED THE TEMPORARY CROSS-OVER IS TO BE REMOVED AND THE AREA RESTORED TO PRE-CONSTRUCTION CONDITION. THE TRAFFIC CONTROL FOR REMOVAL OF THE TEMPORARY CROSS-OVER SHALL BE CONSISTENT WITH THE TRAFFIC CONTROL IN PHASE 1B WHEN THE CROSS-OVER WAS CONSTRUCTED.

Point CO1 N 13,659,344.75 E 3,285,508.62 Sta 100+00.00
Course from CO1 to PC CROSSOVER1 N 73° 15' 45.72" E Dist 203.25

Curve Data
Curve CROSSOVER1
P.I. Station 104+47.19 N 13,659,473.54 E 3,285,936.86
Delta = 4° 18' 41.92" (LT)
Degree = 0° 53' 03.10"
Tangent = 243.93
Length = 487.64
Radius = 6,480.00
External = 4.59
Long Chord = 487.52
Mid. Ord. = 4.59
P.C. Station 102+03.25 N 13,659,403.29 E 3,285,703.26
P.T. Station 106+90.89 N 13,659,561.15 E 3,286,164.52
C.C. N 13,665,608.76 E 3,283,837.13
Back = N 73° 15' 45.72" E
Ahead = N 68° 57' 03.80" E
Chord Bear = N 71° 06' 24.76" E

Course from PT CROSSOVER1 to PC CROSSOVER2 N 68° 57' 03.80" E Dist 64.96

Curve Data
Curve CROSSOVER2
P.I. Station 108+37.45 N 13,659,613.79 E 3,286,301.30
Delta = 1° 26' 34.30" (RT)
Degree = 0° 53' 03.10"
Tangent = 81.60
Length = 163.18
Radius = 6,480.00
External = 0.51
Long Chord = 163.18
Mid. Ord. = 0.51
P.C. Station 107+55.85 N 13,659,584.48 E 3,286,225.15
P.T. Station 109+19.04 N 13,659,641.17 E 3,286,378.16
C.C. N 13,653,536.86 E 3,288,552.54
Back = N 68° 57' 03.80" E
Ahead = N 70° 23' 38.10" E
Chord Bear = N 69° 40' 20.95" E

Course from PT CROSSOVER2 to CO2 N 70° 23' 38.10" E Dist 120.43

Point CO2 N 13,659,681.57 E 3,286,491.61 Sta 110+39.46

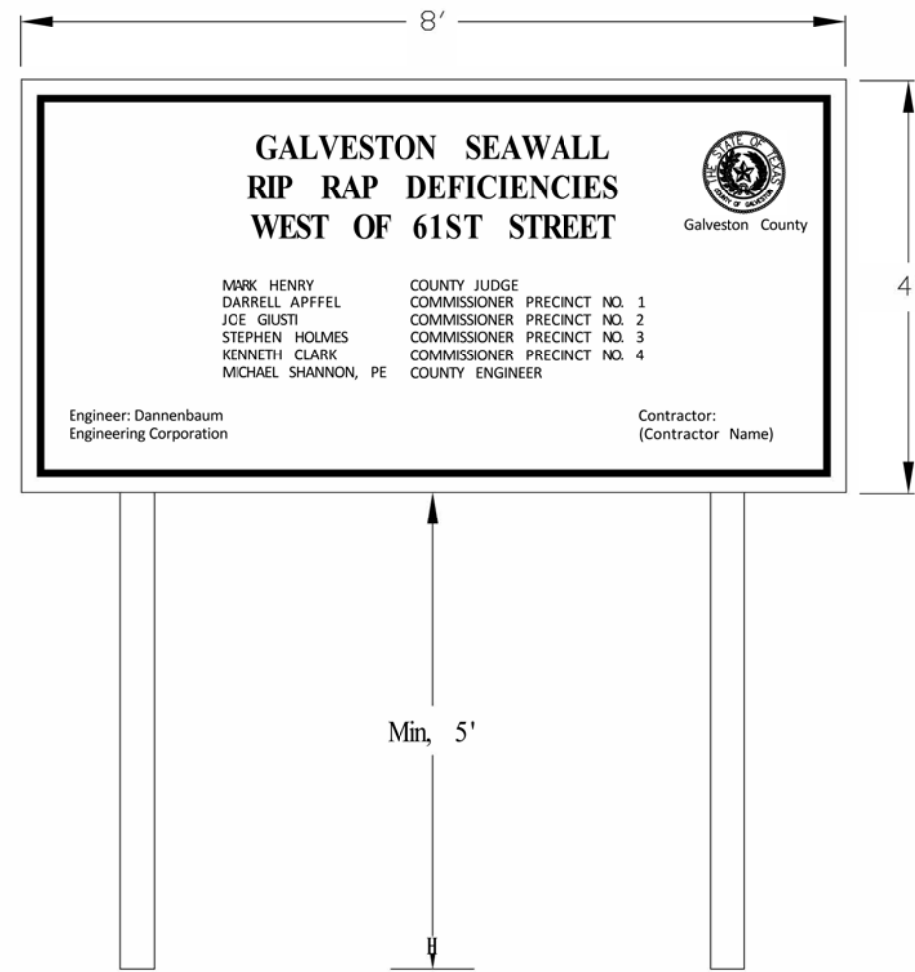

NOT TO SCALE

REV. NO.	DATE	DESCRIPTION	BY



DANNENBAUM
ENGINEERING CORPORATION
T.B.P.E. FIRM REGISTRATION #392
3100 WEST ALABAMA HOUSTON, TX 77098 (713) 520-9570

GALVESTON SEAWALL RIP RAP DEFICIENCIES WEST OF 61st STREET
MAINTENANCE OF TRAFFIC NOTES

SHEET 14 OF 39

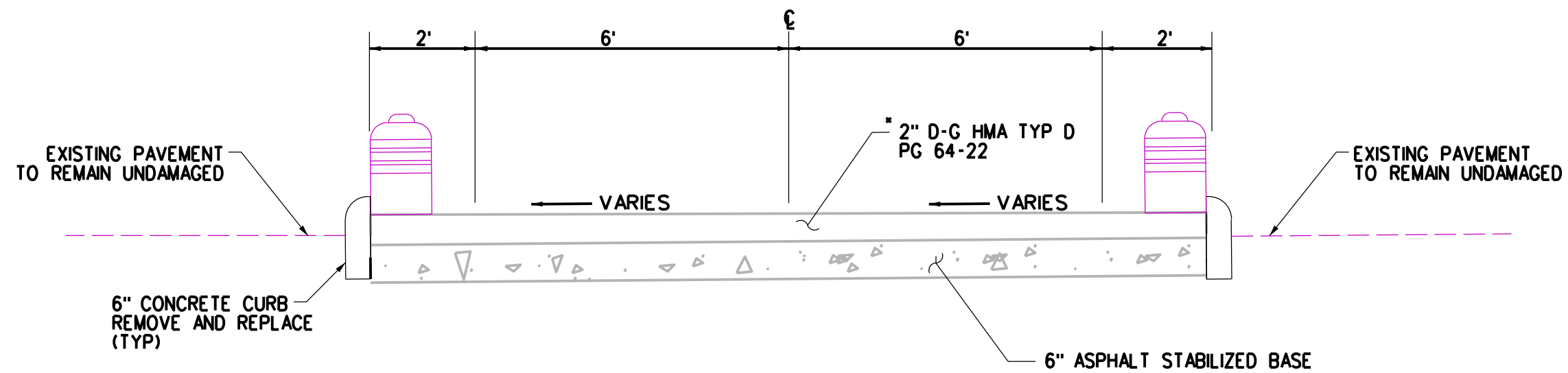

TEMPORARY ASPHALT CROSSOVER DETAIL

* ALL MATERIALS AND WORK FOR CROSSOVER WILL BE PAID FOR UNDER ITEM 0003 - CONSTRUCTING DETOURS (MODIFIED)

NOT TO SCALE

REV. NO.	DATE	DESCRIPTION	BY



DANNENBAUM
ENGINEERING CORPORATION
T.B.P.E. FIRM REGISTRATION #392
3100 WEST ALABAMA HOUSTON, TX 77098 (713) 520-9570

GALVESTON SEAWALL RIP RAP DEFICIENCIES WEST OF 61st STREET

TEMPORARY ASPHALT CROSSOVER DETAIL

SHEET 15 OF 39

SHEET NO. 15

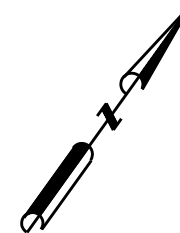

LEGEND			
	Type 3 Barricade		Channelizing Devices
	Heavy Work Vehicle		Truck Mounted Attenuator (TMA)
	Trailer Mounted Flashing Arrow Board		Portable Changeable Message Sign (PCMS)
	Sign		Traffic Flow
	Flag		Flagger

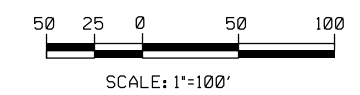

REV. NO.	DATE	DESCRIPTION	BY

DANNENBAUM
ENGINEERING CORPORATION
T.S.P.E. FIRM REGISTRATION #392
3100 WEST ALABAMA HOUSTON, TX 77056 (713) 506-0700

GALVESTON SEAWALL RIP RAP DEFICIENCIES WEST OF 61st STREET

MAINTENANCE OF TRAFFIC PHASE 1A

SHEET 16 OF 39

PHASE 1A

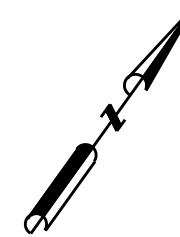
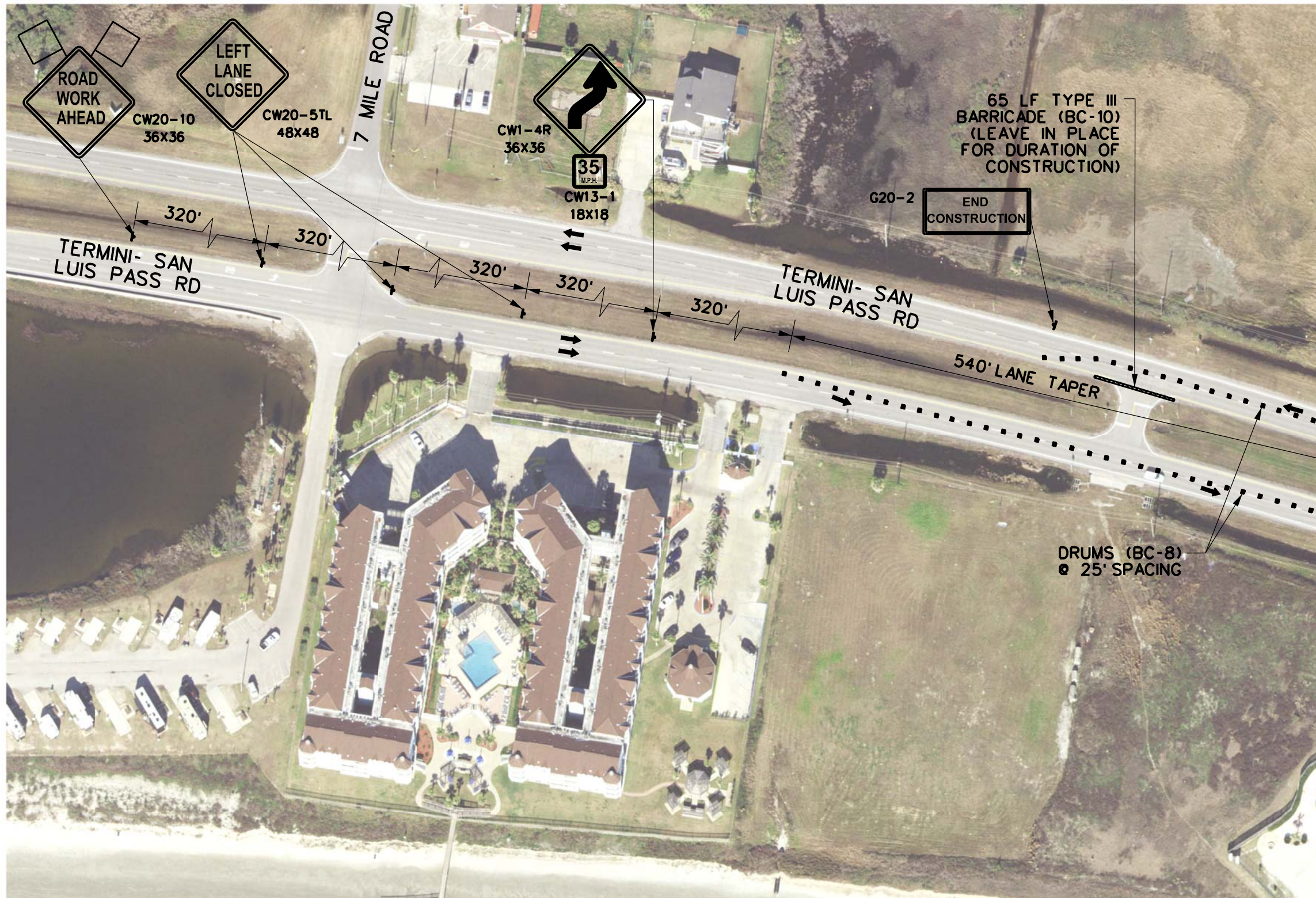

LEGEND			
	Type 3 Barricade		Channelizing Devices
	Heavy Work Vehicle		Truck Mounted Attenuator (TMA)
	Trailer Mounted Flashing Arrow Board		Portable Changeable Message Sign (PCMS)
	Sign		Traffic Flow
	Flag		Flagger

MATCH SHEET 18

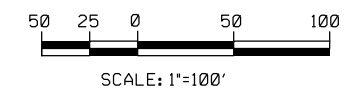

REV. NO.	DATE	DESCRIPTION	BY



DANNENBAUM
ENGINEERING CORPORATION
T.S.P.E. FIRM REGISTRATION #392
3100 WEST ALABAMA HOUSTON, TX 77056 (713) 506-6770

GALVESTON SEAWALL RIP RAP DEFICIENCIES WEST OF 61st STREET

MAINTENANCE OF TRAFFIC PHASE 1B

SHEET 17 OF 39

PHASE 1B

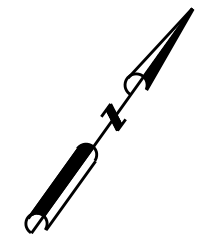

LEGEND			
	Type 3 Barricade		Channelizing Devices
	Heavy Work Vehicle		Truck Mounted Attenuator (TMA)
	Trailer Mounted Flashing Arrow Board		Portable Changeable Message Sign (PCMS)
	Sign		Traffic Flow
	Flag		Flagger

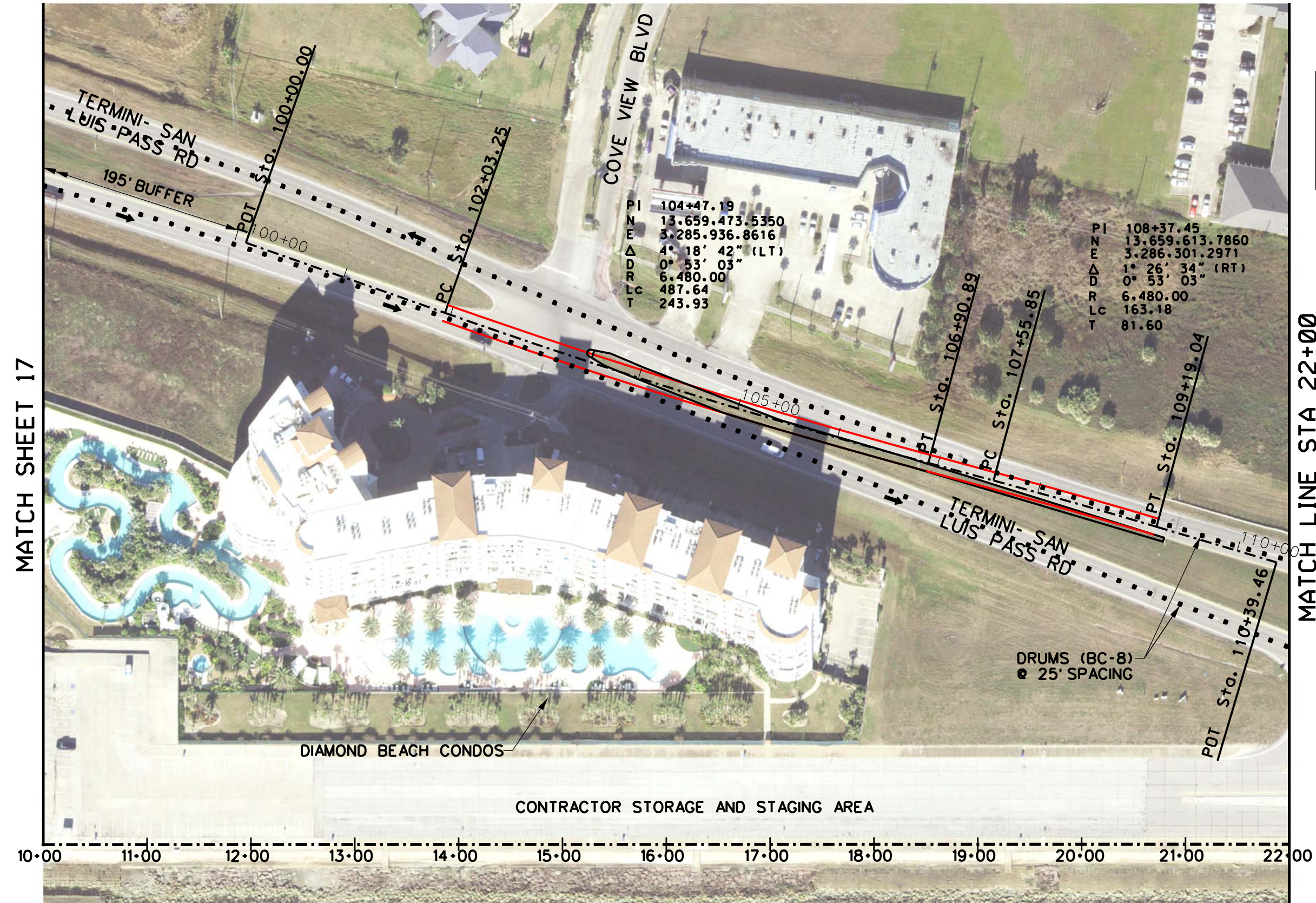
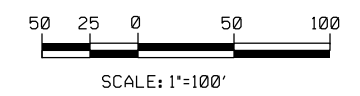

MATCH SHEET 17

MATCH LINE STA 22+00

10+00 11+00 12+00 13+00 14+00 15+00 16+00 17+00 18+00 19+00 20+00 21+00 22+00

PHASE 1B

REV. NO.	DATE	DESCRIPTION	BY

DANNENBAUM
ENGINEERING CORPORATION
T.S.P.E. FIRM REGISTRATION #392
3100 WEST ALABAMA HOUSTON, TX 77056 (713) 504-9770

GALVESTON SEAWALL RIP RAP DEFICIENCIES WEST OF 61st STREET

MAINTENANCE OF TRAFFIC PHASE 1B

SHEET 18 OF 39

SHEET NO. 18

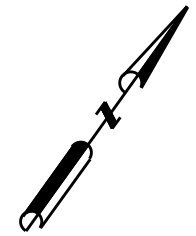

LEGEND			
	Type 3 Barricade		Channelizing Devices
	Heavy Work Vehicle		Truck Mounted Attenuator (TMA)
	Trailer Mounted Flashing Arrow Board		Portable Changeable Message Sign (PCMS)
	Sign		Traffic Flow
	Flag		Flagger

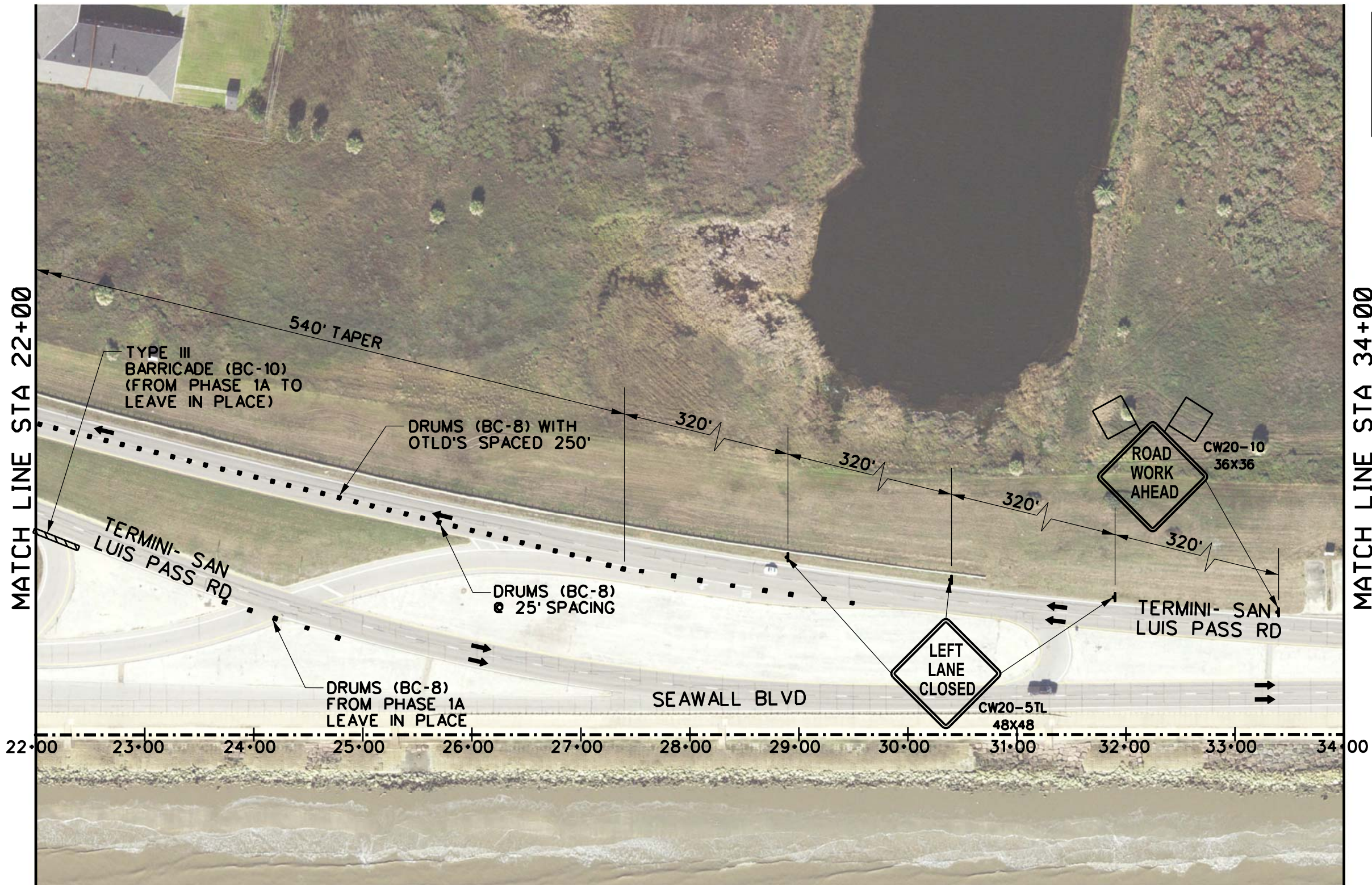
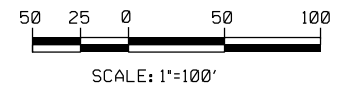

PHASE 1B

REV. NO.	DATE	DESCRIPTION	BY

DANNENBAUM
ENGINEERING CORPORATION
T.S.P.E. FIRM REGISTRATION #392
3100 WEST ALABAMA HOUSTON, TX 77056 (713) 506-9770

GALVESTON SEAWALL RIP RAP DEFICIENCIES WEST OF 61st STREET

MAINTENANCE OF TRAFFIC PHASE 1B

SHEET 19 OF 39

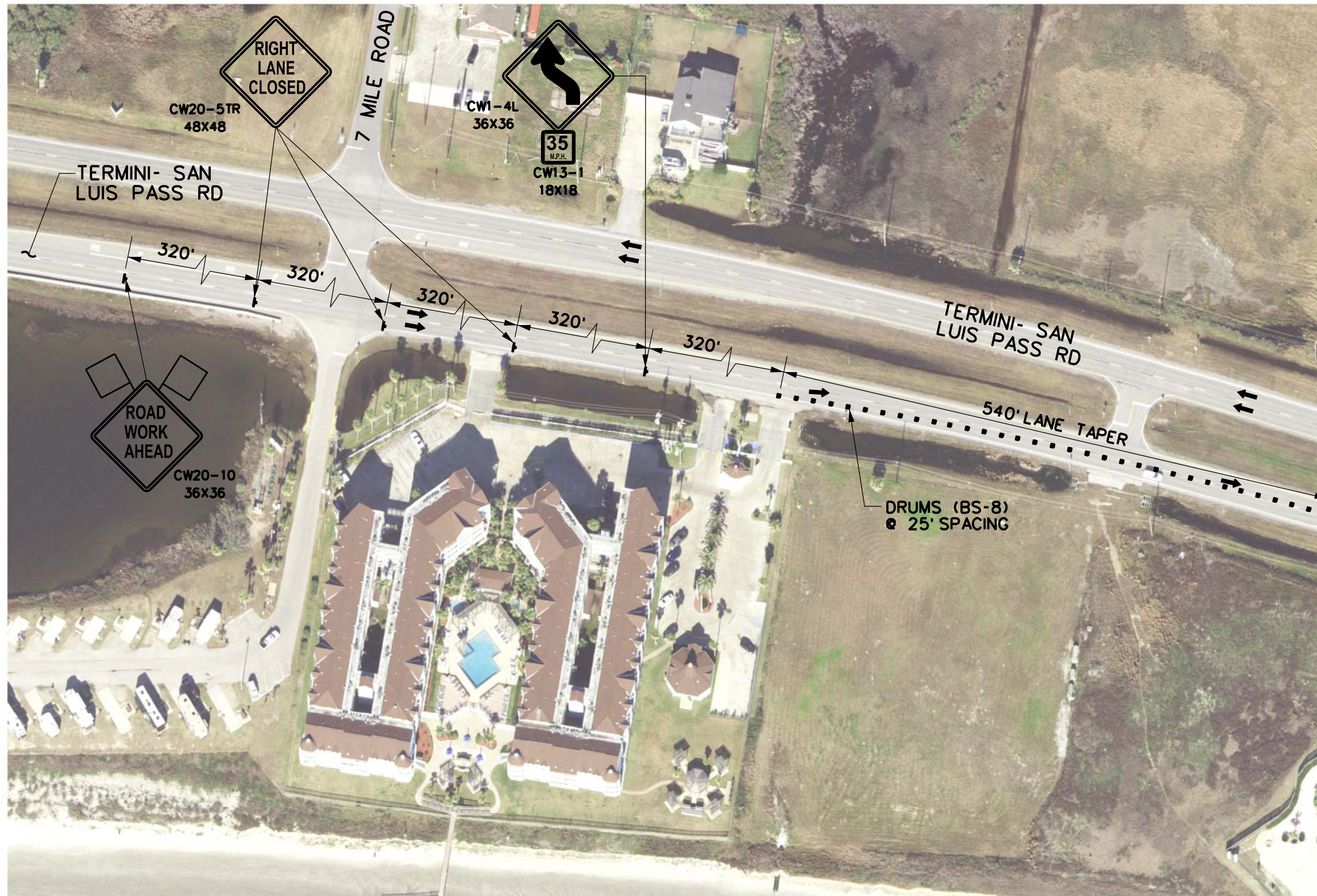

LEGEND			
	Type 3 Barricade		Channelizing Devices
	Heavy Work Vehicle		Truck Mounted Attenuator (TMA)
	Trailer Mounted Flashing Arrow Board		Portable Changeable Message Sign (PCMS)
	Sign		Traffic Flow
	Flag		Flagger

MATCH SHEET 21

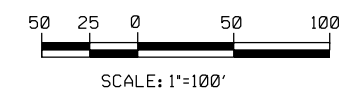

REV. NO.	DATE	DESCRIPTION	BY



DANNENBAUM
ENGINEERING CORPORATION
T.S.P.E. FIRM REGISTRATION #392
3100 WEST ALABAMA HOUSTON, TX 77056 (713) 504-9770

GALVESTON SEAWALL RIP RAP DEFICIENCIES WEST OF 61st STREET

MAINTENANCE OF TRAFFIC PHASE 2

SHEET 20 OF 39

PHASE 2

SHEET NO. 20

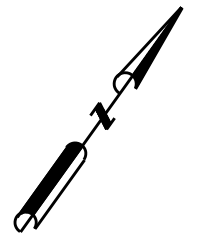

LEGEND			
	Type 3 Barricade		Channelizing Devices
	Heavy Work Vehicle		Truck Mounted Attenuator (TMA)
	Trailer Mounted Flashing Arrow Board		Portable Changeable Message Sign (PCMS)
	Sign		Traffic Flow
	Flag		Flagger

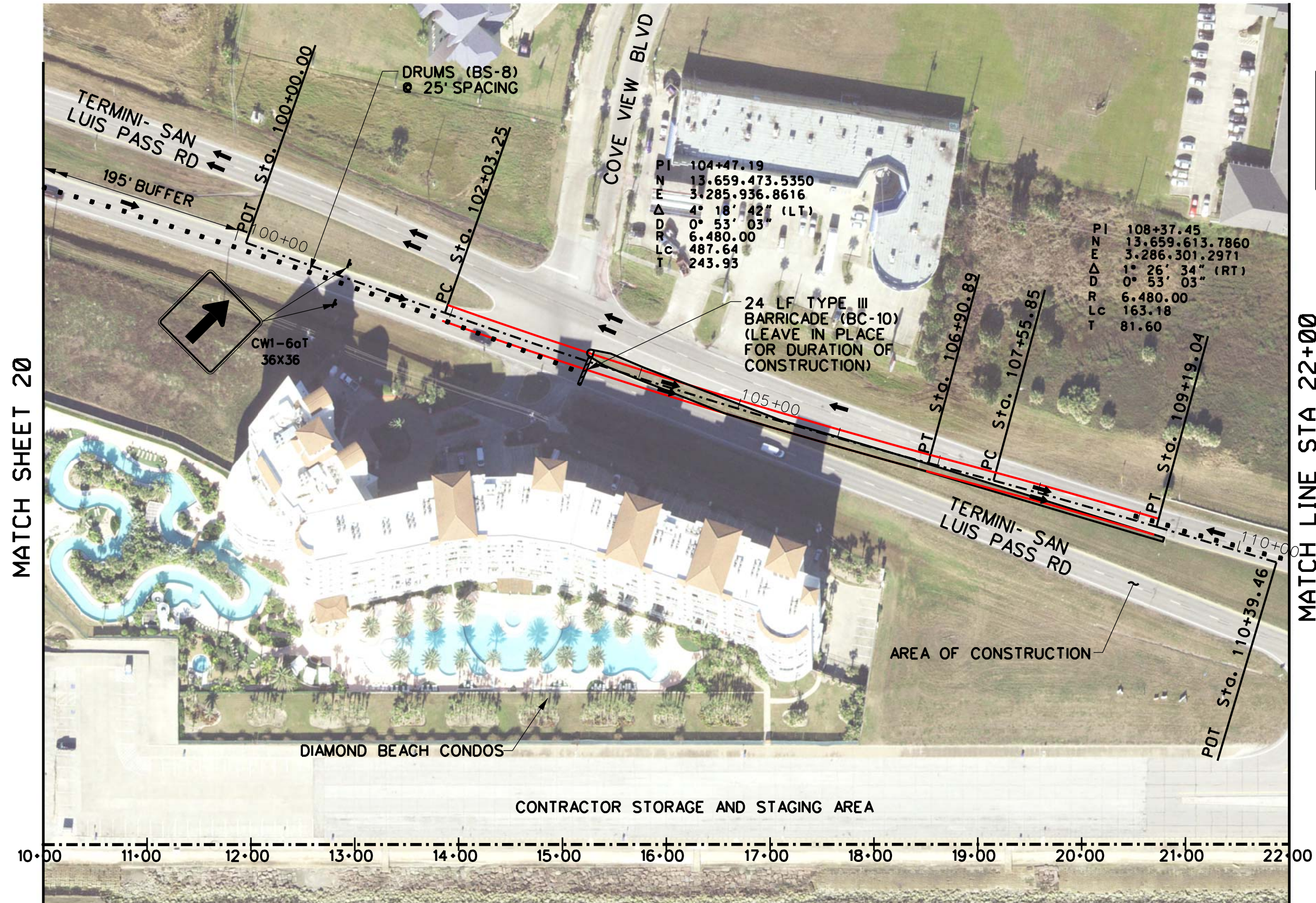
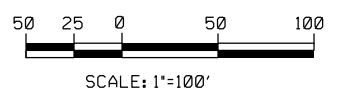



MATCH SHEET 20

MATCH LINE STA 22+00

PHASE 2

REV. NO.	DATE	DESCRIPTION	BY

DANNENBAUM
ENGINEERING CORPORATION
T.S.P.E. FIRM REGISTRATION #392
3100 WEST ALABAMA HOUSTON, TX 77056 (713) 504-9770

GALVESTON SEAWALL RIP RAP DEFICIENCIES WEST OF 61st STREET

MAINTENANCE OF TRAFFIC PHASE 2

SHEET 21 OF 39

SHEET NO. 21

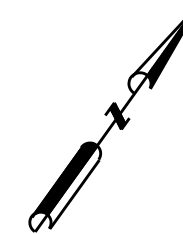

LEGEND			
	Type 3 Barricade		Channelizing Devices
	Heavy Work Vehicle		Truck Mounted Attenuator (TMA)
	Trailer Mounted Flashing Arrow Board		Portable Changeable Message Sign (PCMS)
	Sign		Traffic Flow
	Flag		Flagger

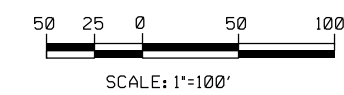
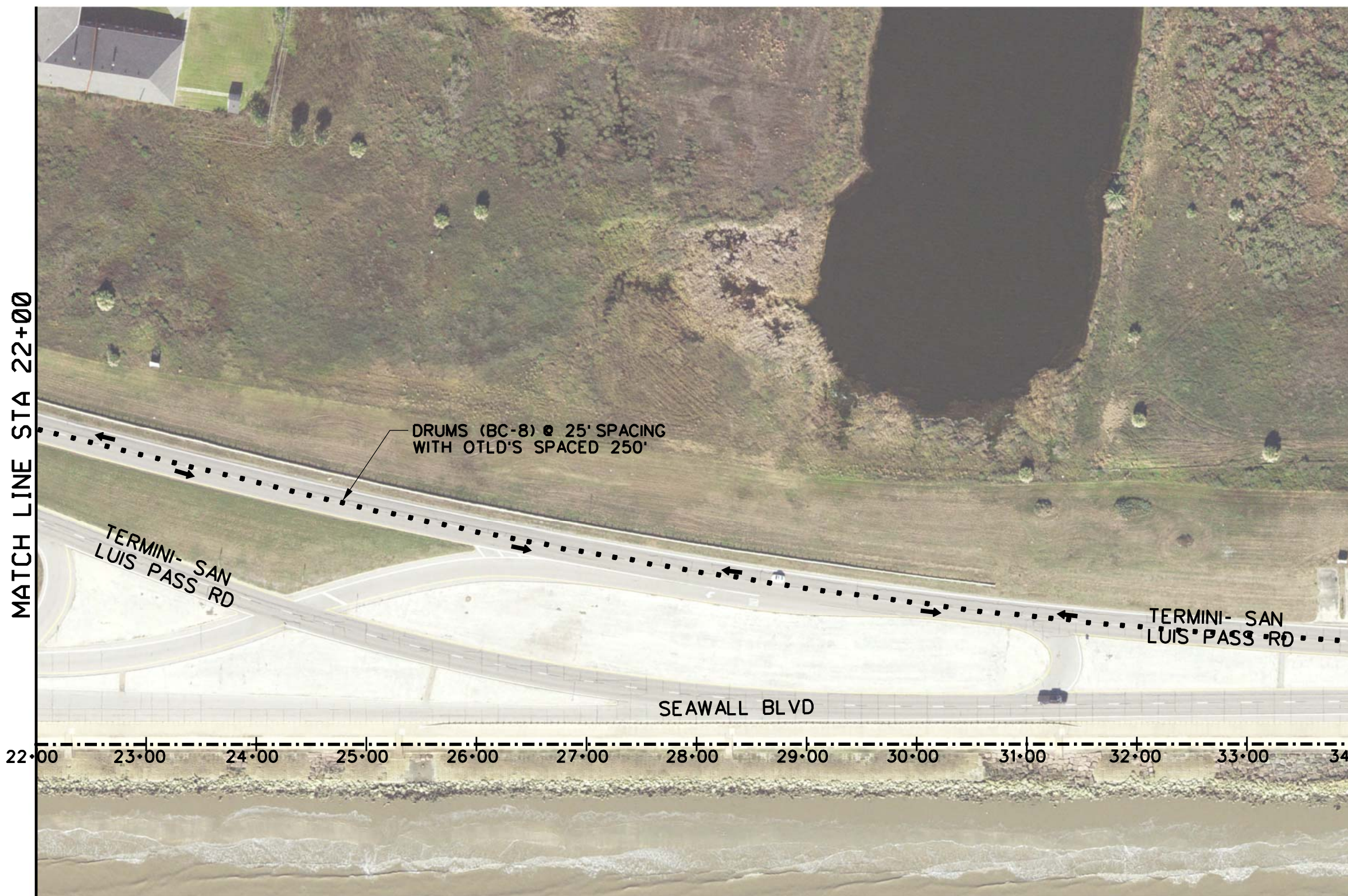

REV. NO.	DATE	DESCRIPTION	BY



DANNENBAUM
ENGINEERING CORPORATION
T.B.P.E. FIRM REGISTRATION #392
3100 WEST ALABAMA HOUSTON, TX 77056 (713) 506-6770

GALVESTON SEAWALL RIP RAP DEFICIENCIES WEST OF 61st STREET

MAINTENANCE OF TRAFFIC PHASE 2

SHEET 22 OF 39

PHASE 2

SHEET NO. 22

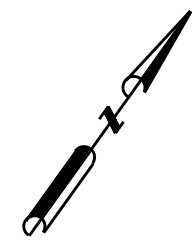

LEGEND			
	Type 3 Barricade		Channelizing Devices
	Heavy Work Vehicle		Truck Mounted Attenuator (TMA)
	Trailer Mounted Flashing Arrow Board		Portable Changeable Message Sign (PCMS)
	Sign		Traffic Flow
	Flag		Flagger

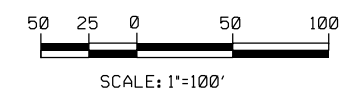

DRUMS (BC-8) @ 25' SPACING WITH OTLD'S SPACED 250'

AREA OF CONSTRUCTION

DRUMS (BC-8) @ 25' SPACING

MATCH LINE STA 34+00

MATCH LINE STA 46+00

34+00 35+00 36+00 37+00 38+00 39+00 40+00 41+00 42+00 43+00 44+00 45+00 46+00

PHASE 2

REV. NO.	DATE	DESCRIPTION	BY

DANNENBAUM
ENGINEERING CORPORATION
T.B.P.E. FIRM REGISTRATION #392
3100 WEST ALABAMA HOUSTON, TX 77098 (713) 520-0570

GALVESTON SEAWALL RIP RAP DEFICIENCIES WEST OF 61st STREET

MAINTENANCE OF TRAFFIC PHASE 2

SHEET 23 OF 39

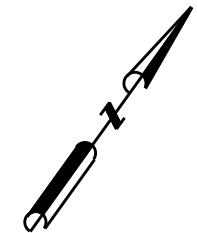

LEGEND			
	Type 3 Barricade		Channelizing Devices
	Heavy Work Vehicle		Truck Mounted Attenuator (TMA)
	Trailer Mounted Flashing Arrow Board		Portable Changeable Message Sign (PCMS)
	Sign		Traffic Flow
	Flag		Flagger

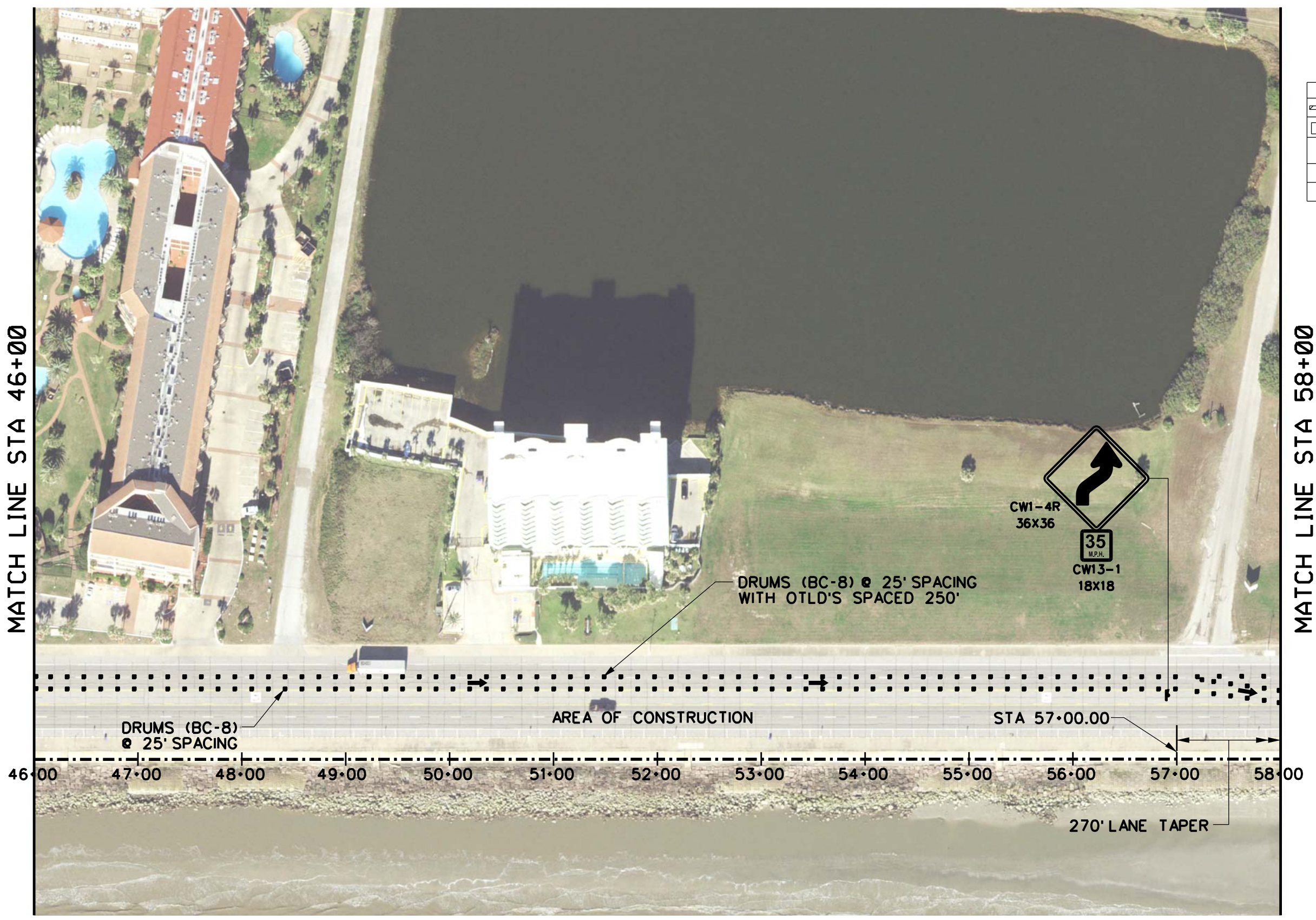
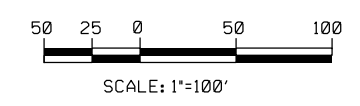

MATCH LINE STA 46+00

MATCH LINE STA 58+00

46+00 47+00 48+00 49+00 50+00 51+00 52+00 53+00 54+00 55+00 56+00 57+00 58+00

DRUMS (BC-8)
@ 25' SPACING

DRUMS (BC-8) @ 25' SPACING
WITH OTLD'S SPACED 250'

AREA OF CONSTRUCTION

STA 57+00.00

270' LANE TAPER

CW1-4R
36X36

35
M.P.H.

CW13-1
18X18

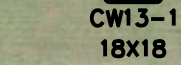

PHASE 2

REV. NO.	DATE	DESCRIPTION	BY

DANNENBAUM
ENGINEERING CORPORATION
T.B.P.E. FIRM REGISTRATION #392
3100 WEST ALABAMA HOUSTON, TX 77098 (713) 528-6570

GALVESTON SEAWALL RIP RAP DEFICIENCIES WEST OF 61st STREET

MAINTENANCE OF TRAFFIC PHASE 2

SHEET 24 OF 39

SHEET NO. 24

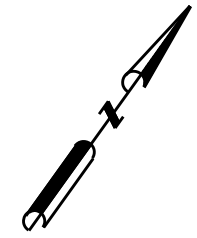

LEGEND			
	Type 3 Barricade		Channelizing Devices
	Heavy Work Vehicle		Truck Mounted Attenuator (TMA)
	Trailer Mounted Flashing Arrow Board		Portable Changeable Message Sign (PCMS)
	Sign		Traffic Flow
	Flag		Flagger

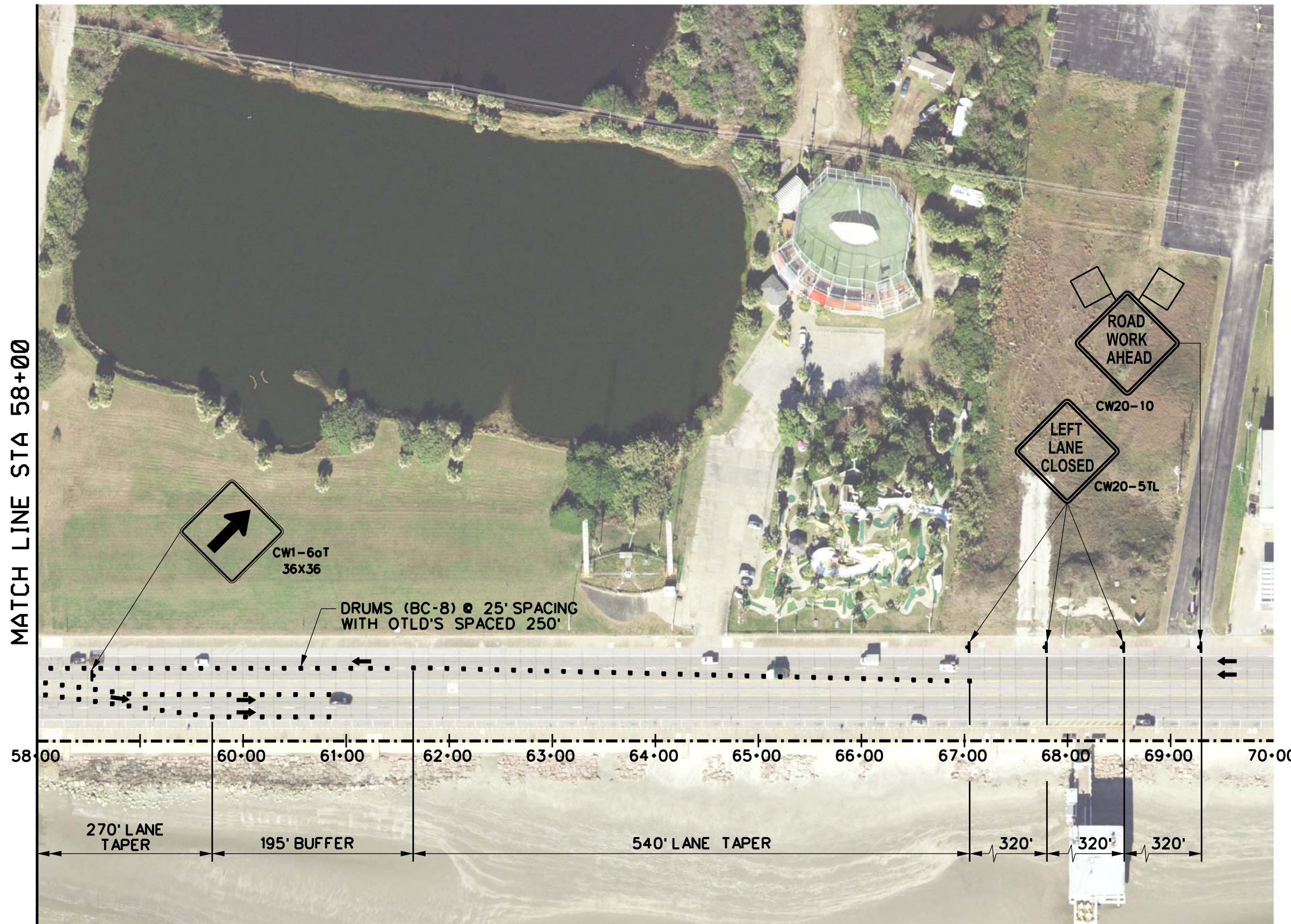
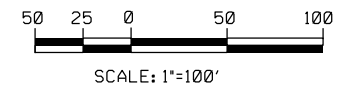

MATCH LINE STA 58+00

PHASE 2

REV. NO.	DATE	DESCRIPTION	BY

DANNENBAUM
ENGINEERING CORPORATION
T.O.P.E. FIRM REGISTRATION #3932
3100 WEST ALABAMA HOUSTON, TX 77098 (713) 526-8570

GALVESTON SEAWALL RIP RAP DEFICIENCIES WEST OF 61st STREET

MAINTENANCE OF TRAFFIC PHASE 2

SHEET 25 OF 39

BARRICADE AND CONSTRUCTION (BC) STANDARD SHEETS GENERAL NOTES:

- The Barricade and Construction Standard Sheets (BC sheets) are intended to show typical examples for placement of temporary traffic control devices, construction pavement markings, and typical work zone signs. The information contained in these sheets meet or exceed the requirements shown in the "Texas Manual on Uniform Traffic Control Devices" (TMUTCD).
- The development and design of the Traffic Control Plan (TCP) is the responsibility of the Engineer.
- The Contractor may propose changes to the TCP that are signed and sealed by a licensed professional engineer for approval. The Engineer may develop, sign and seal Contractor proposed changes.
- The Contractor is responsible for installing and maintaining the traffic control devices as shown in the plans. The Contractor may not move or change the approximate location of any device without the approval of the Engineer.
- Geometric design of lane shifts and detours should, when possible, meet the applicable design criteria contained in manuals such as the American Association of State Highway and Transportation Officials (AASHTO), "A Policy on Geometric Design of Highways and Streets," the TxDOT "Roadway Design Manual" or engineering judgment.
- When projects abut, the Engineer(s) may omit the END ROAD WORK, TRAFFIC FINES DOUBLE, and other advance warning signs if the signing would be redundant and the work areas appear continuous to the motorists. If the adjacent project is completed first, the Contractor shall erect the necessary warning signs as shown on these sheets, the TCP sheets or as directed by the Engineer. The BEGIN ROAD WORK NEXT X MILES sign shall be revised to show appropriate work zone distance.
- The Engineer may require duplicate warning signs on the median side of divided highways where median width will permit and traffic volumes justify the signing.
- All signs shall be constructed in accordance with the details found in the "Standard Highway Sign Designs for Texas," latest edition. Sign details not shown in this manual shall be shown in the plans or the Engineer shall provide a detail to the Contractor before the sign is manufactured.
- The temporary traffic control devices shown in the illustrations of the BC sheets are examples. As necessary, the Engineer will determine the most appropriate traffic control devices to be used.
- As shown on BC(2), the OBEY WARNING SIGNS STATE LAW sign, STAY ALERT TALK OR TEXT LATER (see Sign Detail G20-10T) and the WORK ZONE TRAFFIC FINES DOUBLE sign with plaque shall be erected in advance of the CSJ limits. However, the TRAFFIC FINES DOUBLE sign will not be required on projects consisting solely of mobile operation work, such as striping or milling edgeline rumble strips. The BEGIN ROAD WORK NEXT X MILES, CONTRACTOR and END ROAD WORK signs shall be erected at or near the CSJ limits.
- Except for devices required by Note 10, traffic control devices should be in place only while work is actually in progress or a definite need exists.
- The Engineer has the final decision on the location of all traffic control devices.
- Inactive equipment and work vehicles, including workers' private vehicles must be parked away from travel lanes. They should be as close to the right-of-way line as possible, or located behind a barrier or guardrail, or as approved by the Engineer.

WORKER SAFETY APPAREL NOTES:

- Workers on foot who are exposed to traffic or to construction equipment within the right-of-way shall wear high-visibility safety apparel meeting the requirements of ISEA "American National Standard for High-Visibility Apparel," or equivalent revisions, and labeled as ANSI 107-2004 standard performance for Class 2 or 3 risk exposure. Class 3 garments should be considered for high traffic volume work areas or night time work.

DISCLAIMER: The use of this standard is governed by the "Texas Engineering Practice Act". No warranty of any kind is made by TxDOT for any purpose whatsoever. TxDOT assumes no responsibility for the conversion of this standard to other formats or for incorrect results or damages resulting from its use.

DATE:
FILE:

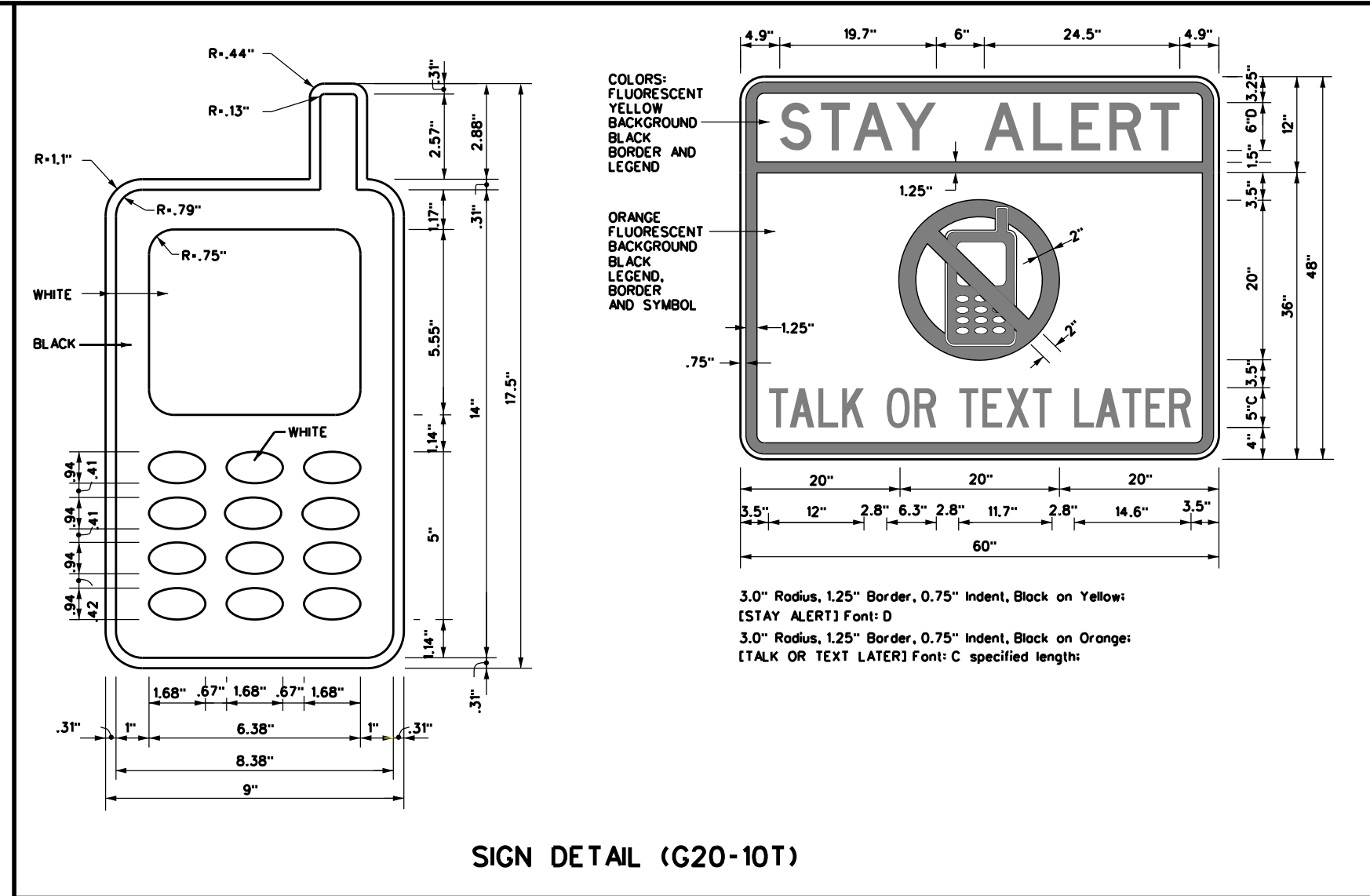

Only pre-qualified products shall be used. The "Compliant Work Zone Traffic Control Devices List" (CWZTCD) describes pre-qualified products and their sources and may be found on-line at the web address given below or by contacting:

Texas Department of Transportation
Traffic Operations Division - TE
Phone (512) 416-3118

THE DOCUMENTS BELOW CAN BE FOUND ON-LINE AT http://www.txdot.gov
COMPLIANT WORK ZONE TRAFFIC CONTROL DEVICES LIST (CWZTCD)
DEPARTMENTAL MATERIAL SPECIFICATIONS (DMS)
MATERIAL PRODUCER LIST (MPL)
ROADWAY DESIGN MANUAL - SEE "MANUALS (ONLINE MANUALS)"
STANDARD HIGHWAY SIGN DESIGNS FOR TEXAS (SHSD)
TEXAS MANUAL ON UNIFORM TRAFFIC CONTROL DEVICES (TMUTCD)
TRAFFIC ENGINEERING STANDARD SHEETS

SHEET 1 OF 12

		<i>Traffic Operations Division Standard</i>	
BARRICADE AND CONSTRUCTION GENERAL NOTES AND REQUIREMENTS			
BC(1)-14			
FILE: bc-14.dgn	DN: TxDOT	CK: TxDOT	DW: TxDOT
© TxDOT November 2002	CONT	SECT	JOB
REVISIONS			
4-03	5-10	8-14	
9-07	7-13		
DIST	COUNTY		SHEET NO.
			26

TYPICAL LOCATION OF CROSSROAD SIGNS

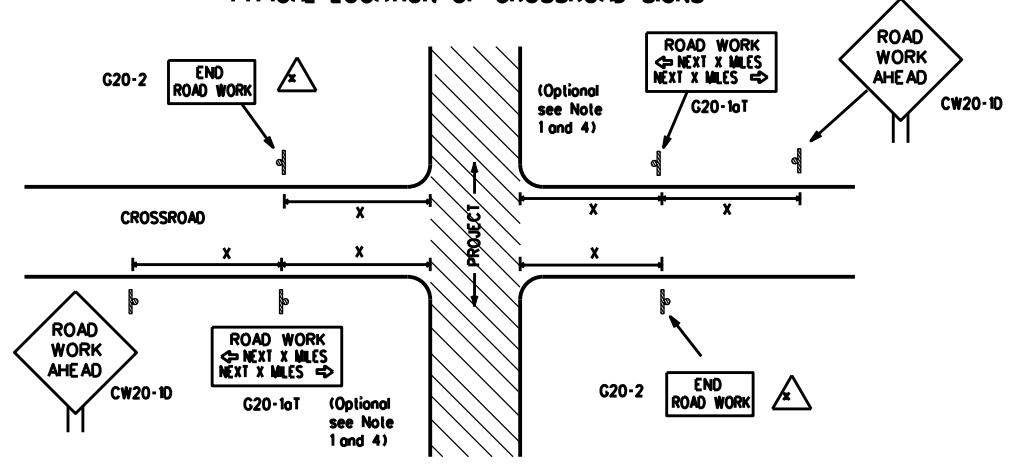

- △ May be mounted on back of "ROAD WORK AHEAD" (CW20-1D) sign with approval of Engineer. (See note 2 below)
- The typical minimum signing on a crossroad approach should be a "ROAD WORK AHEAD" (CW20-1D) sign and a (G20-2) "END ROAD WORK" sign, unless noted otherwise in plans.
 - The Engineer may use the reduced size 36" x 36" ROAD WORK AHEAD (CW20-1D) sign mounted back to back with the reduced size 36" x 18" "END ROAD WORK" (G20-2) sign on low volume crossroads (see Note 4 under "Typical Construction Warning Sign Size and Spacing"). See the "Standard Highway Sign Designs for Texas" manual for sign details. The Engineer may omit the advance warning signs on low volume crossroads. The Engineer will determine whether a road is low volume. This information shall be shown in the plans.
 - Based on existing field conditions, the Engineer/Inspector may require additional signs such as FLAGGER AHEAD, LOOSE GRAVEL, or other appropriate signs. When additional signs are required, these signs will be considered part of the minimum requirements. The Engineer/Inspector will determine the proper location and spacing of any sign not shown on the BC sheets, Traffic Control Plan sheets or the Work Zone Standard Sheets.
 - The "ROAD WORK NEXT X MILES" (G20-1aT) sign shall be required at high volume crossroads to advise motorists of the length of construction in either direction from the intersection. The Engineer will determine whether a roadway is considered high volume.
 - Additional traffic control devices may be shown elsewhere in the plans for higher volume crossroads.
 - When work occurs in the intersection area, appropriate traffic control devices, as shown elsewhere in the plans or as determined by the Engineer/Inspector, shall be in place.

T-INTERSECTION

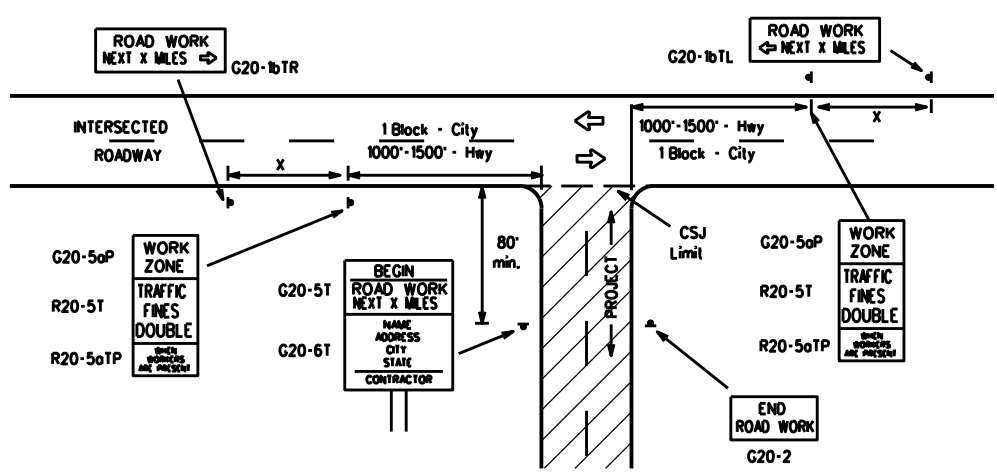

CSJ LIMITS AT T-INTERSECTION

- The Engineer will determine the types and location of any additional traffic control devices, such as a flagger and accompanying signs, or other signs, that should be used when work is being performed at or near an intersection.
- If construction closes the road at a T-intersection the Contractor shall place the "CONTRACTOR NAME" (G20-6T) sign behind the Type 3 Barricades for the road closure (see BC(10) also). The "ROAD WORK NEXT X MILES" left arrow (G20-1bTL) and "ROAD WORK NEXT X MILES" right arrow (G20-1bTR) signs shall be replaced by the detour signing called for in the plans.

TYPICAL CONSTRUCTION WARNING SIGN SIZE AND SPACING

Sign Number or Series	SIZE		SPACING	
	Conventional Road	Expressway/Freeway	Posted Speed MPH	Sign Spacing "X" Feet (Apprx.)
CW20 ⁴	48" x 48"	48" x 48"	30	120
CW21			35	160
CW22			40	240
CW23			45	320
CW25			50	400
CW1, CW2, CW7, CW8, CW9, CW11, CW14	36" x 36"	48" x 48"	60	600 ²
CW3, CW4, CW5, CW6, CW8-3, CW10, CW12	48" x 48"	48" x 48"	65	700 ²
			70	800 ²
			75	900 ²
			80	1000 ²
			*	* ³

- For typical sign spacings on divided highways, expressways and freeways, see Part 6 of the "Texas Manual on Uniform Traffic Control Devices" (TMUTCD) typical application diagrams or TCP Standard Sheets.
- Minimum distance from work area to first Advance Warning sign nearest the work area and/or distance between each additional sign.

GENERAL NOTES

- Special or larger size signs may be used as necessary.
- Distance between signs should be increased as required to have 1500 feet advance warning.
- Distance between signs should be increased as required to have 1/2 mile or more advance warning.
- 36" x 36" "ROAD WORK AHEAD" (CW20-1D) signs may be used on low volume crossroads at the discretion of the Engineer. See Note 2 under "Typical Location of Crossroad Signs".
- Only diamond shaped warning sign sizes are indicated.
- See sign size listing in "TMUTCD", Sign Appendix or the "Standard Highway Sign Designs for Texas" manual for complete list of available sign design sizes.

WORK AREAS IN MULTIPLE LOCATIONS WITHIN CSJ LIMITS

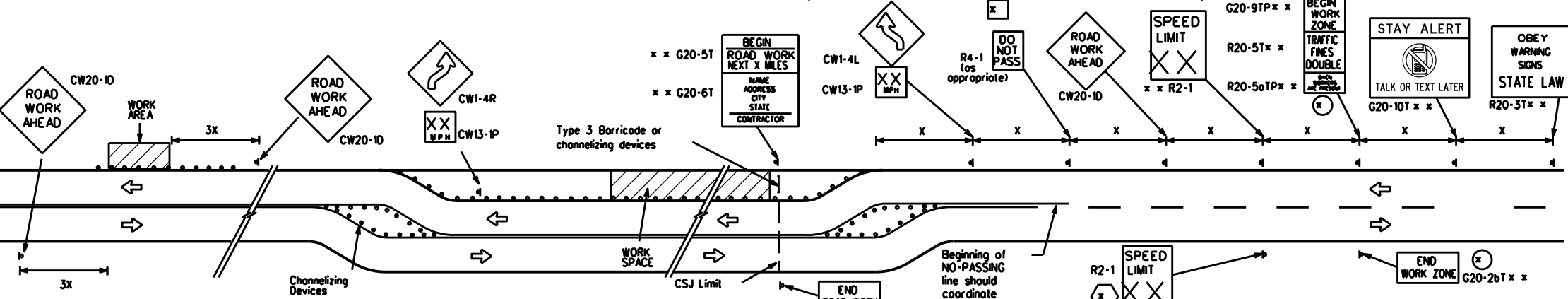

When extended distances occur between minimal work spaces, the Engineer/Inspector should ensure additional "ROAD WORK AHEAD" (CW20-1D) signs are placed in advance of these work areas to remind drivers they are still within the project limits. See the applicable TCP sheets for exact location and spacing of signs and channelizing devices.

SAMPLE LAYOUT OF SIGNING FOR WORK BEGINNING DOWNSTREAM OF THE CSJ LIMITS

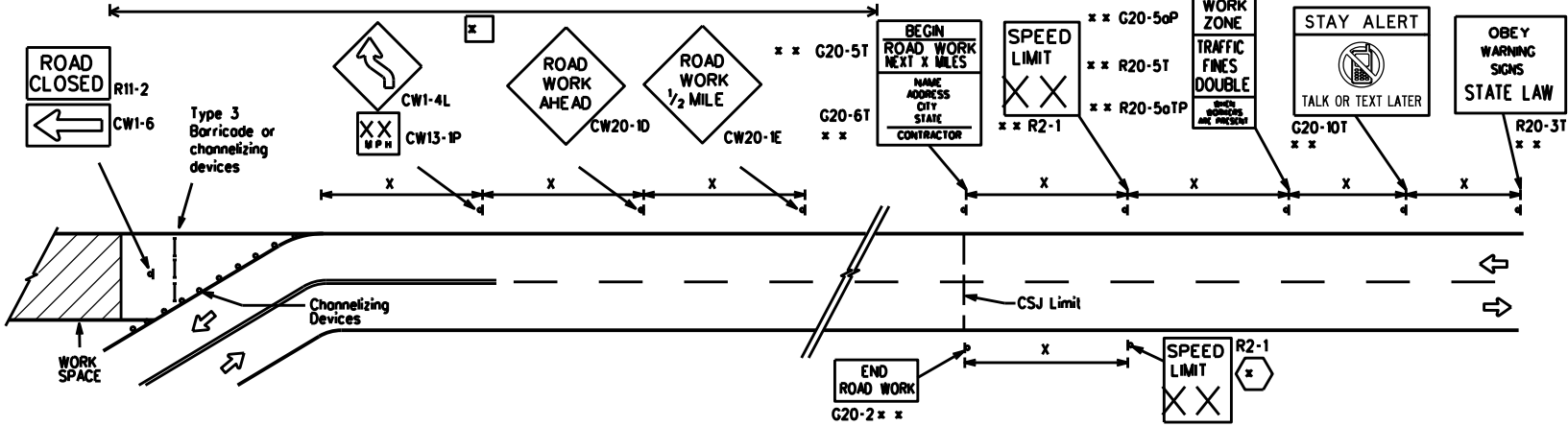

SAMPLE LAYOUT OF SIGNING FOR WORK BEGINNING AT THE CSJ LIMITS

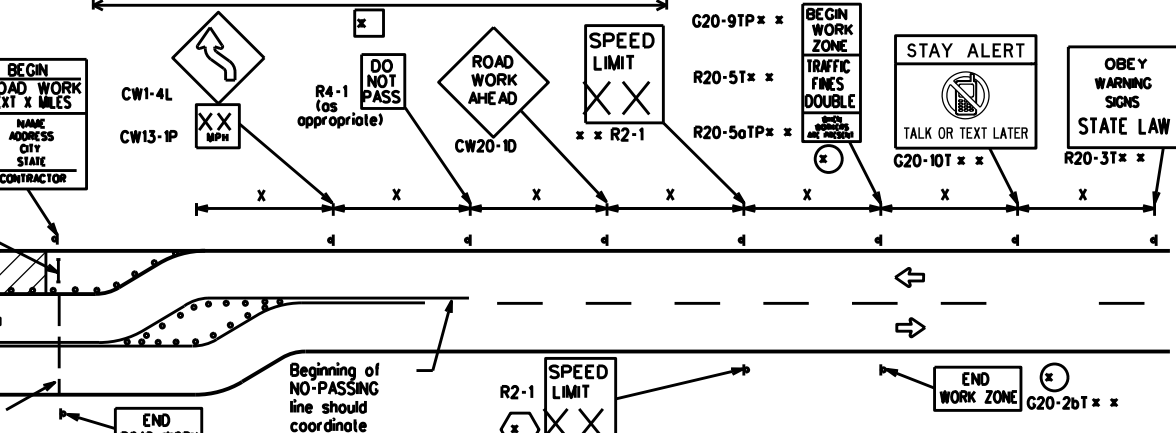

NOTES

- The Contractor shall determine the appropriate distance to be placed on the G20-1 series signs and "BEGIN ROAD WORK NEXT X MILES" (G20-5T) sign for each specific project. This distance shall replace the "X" and shall be rounded to the nearest whole mile with the approval of the Engineer. No decimals shall be used.
- The "BEGIN WORK ZONE" (G20-9TP) and "END WORK ZONE" (G20-2bT) shall be used as shown on the sample layout when advance signs are required outside the CSJ Limits. They inform the motorist of entering or leaving a part of the work zone lying outside the CSJ Limits where traffic fines may double if workers are present.
- Required CSJ Limit signing. See Note 10 on BC(1). TRAFFIC FINES DOUBLE signs will not be required on projects consisting solely of mobile operations work.
- Area for placement of "ROAD WORK AHEAD" (CW20-1D) sign and other signs or devices as called for on the Traffic Control Plan.
- Contractor will install a regulatory speed limit sign at the end of the work zone.

LEGEND	
—	Type 3 Barricade
○ ○ ○	Channelizing Devices
■	Sign
X	See Typical Construction Warning Sign Size and Spacing chart or the TMUTCD for sign spacing requirements.

BARRICADE AND CONSTRUCTION PROJECT LIMIT

BC(2)-14

FILE: bc-14.dgn	DN: TxDOT	CK: TxDOT	DW: TxDOT	CK: TxDOT
© TxDOT November 2002	CONT	SECT	JOB	HIGHWAY
REVISIONS				
9-07 8-14				
7-13				
	DIST	COUNTY		SHEET NO.
				27

DISCLAIMER: The use of this standard is governed by the "Texas Engineering Practice Act". No warranty of any kind is made by TxDOT for any purpose whatsoever. TxDOT assumes no responsibility for the conversion of this standard to other formats or for incorrect results or damages resulting from its use.

DATE: FILE:

TYPICAL APPLICATION OF WORK ZONE SPEED LIMIT SIGNS

Work zone speed limits shall be regulatory, established in accordance with the "Procedures for Establishing Speed Zones," and approved by the Texas Transportation Commission, or by City Ordinance when within Incorporated City Limits.

Reduced speeds should only be posted in the vicinity of work activity and not throughout the entire project. Regulatory work zone speed signs (R2-1) shall be removed or covered during periods when they are not needed.

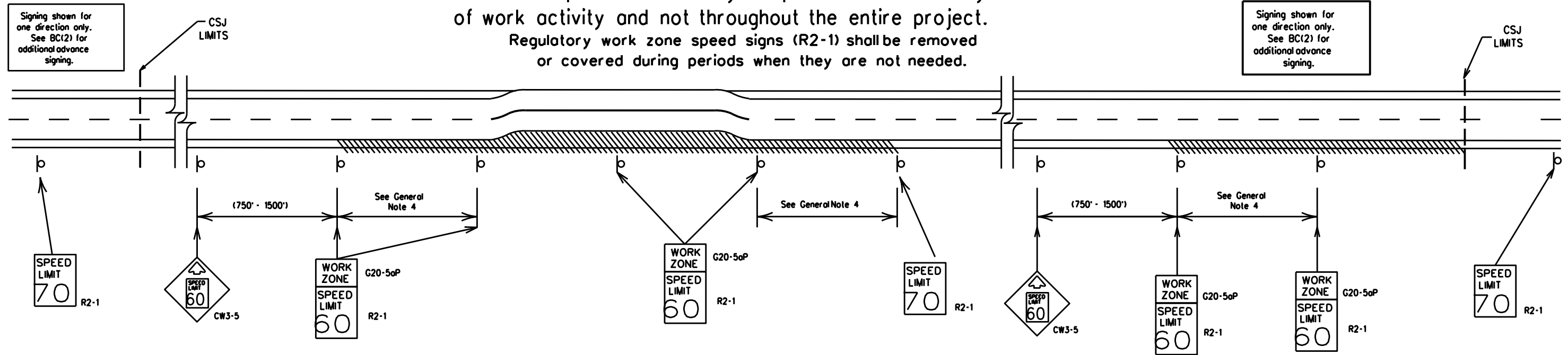

GUIDANCE FOR USE:

LONG/INTERMEDIATE TERM WORK ZONE SPEED LIMITS

This type of work zone speed limit should be included on the design of the traffic control plans when restricted geometrics with a lower design speed are present in the work zone and modification of the geometrics to a higher design speed is not feasible.

Long/Intermediate Term Work Zone Speed Limit signs, when approved as described above, should be posted and visible to the motorist when work activity is present. Work activity may also be defined as a change in the roadway that requires a reduced speed for motorists to safely negotiate the work area, including:

- rough road or damaged pavement surface
- substantial alteration of roadway geometrics (diversions)
- construction detours
- grade
- width
- other conditions readily apparent to the driver

As long as any of these conditions exist, the work zone speed limit signs should remain in place.

SHORT TERM WORK ZONE SPEED LIMITS

This type of work zone speed limit may be included on the design of the traffic control plans when workers or equipment are not behind concrete barrier, when work activity is within 10 feet of the traveled way or actually in the traveled way.

Short Term Work Zone Speed Limit signs should be posted and visible to the motorists only when work activity is present. When work activity is not present, signs shall be removed or covered. (See Removing or Covering on BC(4)).

GENERAL NOTES

- Regulatory work zone speed limits should be used only for sections of construction projects where speed control is of major importance.
- Regulatory work zone speed limit signs shall be placed on supports at a 7 foot minimum mounting height.
- Speed zone signs are illustrated for one direction of travel and are normally posted for each direction of travel.
- Frequency of work zone speed limit signs should be:
 - 40 mph and greater 0.2 to 2 miles
 - 35 mph and less 0.2 to 1 mile
- Regulatory speed limit signs shall have black legend and border on a white reflective background (See "Reflective Sheeting" on BC(4)).
- Fabrication, erection and maintenance of the "ADVANCE SPEED LIMIT" (CW3-5) sign, "WORK ZONE" (G20-5aP) plaque and the "SPEED LIMIT" (R2-1) signs shall not be paid for directly, but shall be considered subsidiary to Item 502.
- Turning signs from view, laying signs over or down will not be allowed, unless as otherwise noted under "REMOVING OR COVERING" on BC(4).
- Techniques that may help reduce traffic speeds include but are not limited to:
 - Low enforcement.
 - Flagger stationed next to sign.
 - Portable changeable message sign (PCMS).
 - Low-power (drone) radar transmitter.
 - Speed monitor trailers or signs.
- Speeds shown on details above are for illustration only. Work Zone Speed Limits should only be posted as approved for each project.
- For more specific guidance concerning the type of work, work zone conditions and factors impacting allowable regulatory construction speed zone reduction see TxDOT form #1204 in the TxDOT e-form system.

DISCLAIMER: The use of this standard is governed by the "Texas Engineering Practice Act." No warranty of any kind is made by TxDOT for any purpose whatsoever. TxDOT assumes no responsibility for the conversion of this standard to other formats or for incorrect results or damages resulting from its use.

DATE:
FILE:

SHEET 3 OF 12



BARRICADE AND CONSTRUCTION WORK ZONE SPEED LIMIT

BC(3)-14

FILE: bc-14.dgn	DN: TxDOT	CK: TxDOT	DW: TxDOT	CK: TxDOT
© TxDOT November 2002	CONT	SECT	JOB	HIGHWAY
REVISIONS				
9-07	8-14			
7-13	COUNTY			SHEET NO.
				28

TYPICAL MINIMUM CLEARANCES FOR LONG TERM AND INTERMEDIATE TERM SIGNS

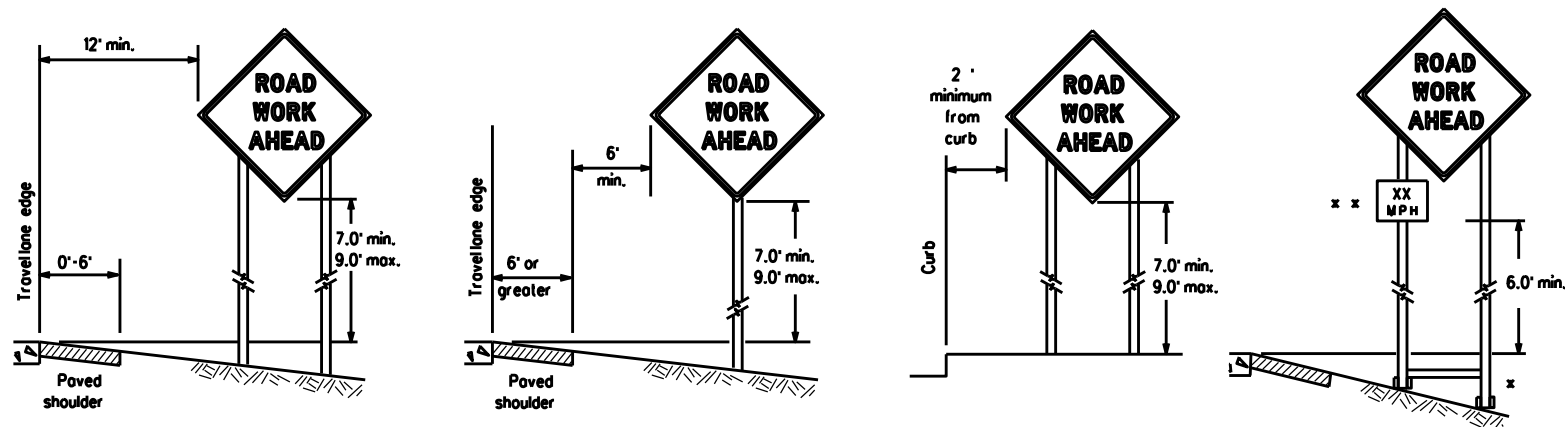

x When placing skid supports on unlevel ground, the leg post lengths must be adjusted so the sign appears straight and plumb. Objects shall NOT be placed under skids as a means of leveling.

x x When plaques are placed on dual-leg supports, they should be attached to the upright nearest the travel lane. Supplemental plaques (advisory or distance) should not cover the surface of the parent sign.

ATTACHMENT FOR SIGN SUPPORTS



Support shall not protrude above sign

Support shall not protrude above sign

Sign supports shall extend more than 1/2 way up the back of the sign substrate.

FRONT ELEVATION
Wood, metal or
Fiber Reinforced Plastic

Splicing embedded perforated square metal tubing in order to extend post height will only be allowed when the splice is made using four bolts, two above and two below the splice point. Splice must be located entirely behind the sign substrate, not near the base of the support. Splice insert lengths should be at least 5 times nominal post size, centered on the splice and of at least the same gauge material.

Attachment to wooden supports will be by bolts and nuts or screws. Use TxDOT's or manufacturer's recommended procedures for attaching sign substrates to other types of sign supports

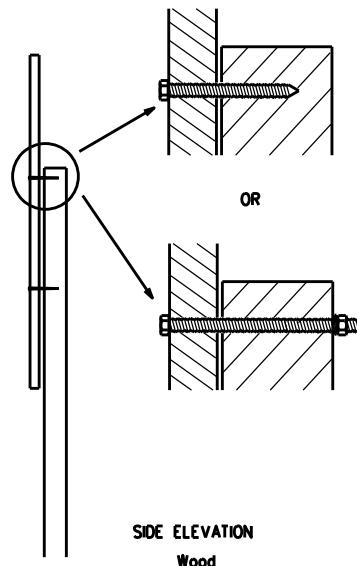

Noils shall NOT be allowed. Each sign shall be attached directly to the sign support. Multiple signs shall not be joined or spliced by any means. Wood supports shall not be extended or repaired by splicing or other means.

SIDE ELEVATION
Wood

GENERAL NOTES FOR WORK ZONE SIGNS

- Contractor shall install and maintain signs in a straight and plumb condition and/or as directed by the Engineer.
 - Wooden sign posts shall be painted white.
 - Barricades shall NOT be used as sign supports.
 - All signs shall be installed in accordance with the plans or as directed by the Engineer. Signs shall be used to regulate, warn, and guide the traveling public safely through the work zone.
 - The Contractor may furnish either the sign design shown in the plans or in the "Standard Highway Sign Designs for Texas" (SHSD). The Engineer/Inspector may require the Contractor to furnish other work zone signs that are shown in the TMUTCD but may have been omitted from the plans. Any variation in the plans shall be documented by written agreement between the Engineer and the Contractor's Responsible Person. All changes must be documented in writing before being implemented. This can include documenting the changes in the Inspector's TxDOT diary and having both the Inspector and Contractor initial and date the agreed upon changes.
 - The Contractor shall furnish sign supports listed in the "Compliant Work Zone Traffic Control Device List" (CWZTCD). The Contractor shall install the sign support in accordance with the manufacturer's recommendations. If there is a question regarding installation procedures, the Contractor shall furnish the Engineer a copy of the manufacturer's installation recommendations so the Engineer can verify the correct procedures are being followed.
 - The Contractor is responsible for installing signs on approved supports and replacing signs with damaged or cracked substrates and/or damaged or marred reflective sheeting as directed by the Engineer/Inspector.
 - Identification markings may be shown only on the back of the sign substrate. The maximum height of letters and/or company logos used for identification shall be 1 inch.
 - The Contractor shall replace damaged wood posts. New or damaged wood sign posts shall not be spliced.
- DURATION OF WORK (as defined by the "Texas Manual on Uniform Traffic Control Devices" Part 6)**
- The types of sign supports, sign mounting height, the size of signs, and the type of sign substrates can vary based on the type of work being performed. The Engineer is responsible for selecting the appropriate size sign for the type of work being performed. The Contractor is responsible for ensuring the sign support, sign mounting height and substrate meets manufacturer's recommendations in regard to crashworthiness and duration of work requirements.
 - Long-term stationary - work that occupies a location more than 3 days.
 - Intermediate-term stationary - work that occupies a location more than one daylight period up to 3 days, or nighttime work lasting more than one hour.
 - Short-term stationary - daytime work that occupies a location for more than 1 hour in a single daylight period.
 - Short, duration - work that occupies a location up to 1 hour.
 - Mobile - work that moves continuously or intermittently (stopping for up to approximately 15 minutes.)

SIGN MOUNTING HEIGHT

- The bottom of Long-term/Intermediate-term signs shall be at least 7 feet, but not more than 9 feet, above the paved surface, except as shown for supplemental plaques mounted below other signs.
- The bottom of Short-term/Short Duration signs shall be a minimum of 1 foot above the pavement surface but no more than 2 feet above the ground.
- Long-term/Intermediate-term Signs may be used in lieu of Short-term/Short Duration signing.
- Short-term/Short Duration signs shall be used only during daylight and shall be removed at the end of the workday or raised to appropriate Long-term/Intermediate sign height.
- Regulatory signs shall be mounted at least 7 feet, but not more than 9 feet, above the paved surface regardless of work duration.

SIZE OF SIGNS

- The Contractor shall furnish the sign sizes shown on BC (2) unless otherwise shown in the plans or as directed by the Engineer.

SIGN SUBSTRATES

- The Contractor shall ensure the sign substrate is installed in accordance with the manufacturer's recommendations for the type of sign support that is being used. The CWZTCD lists each substrate that can be used on the different types and models of sign supports.
- "Mesh" type materials are NOT an approved sign substrate, regardless of the tightness of the weave.
- All wooden individual sign panels fabricated from 2 or more pieces shall have one or more plywood cleat, 1/2" thick by 6" wide, fastened to the back of the sign and extending fully across the sign. The cleat shall be attached to the back of the sign using wood screws that do not penetrate the face of the sign panel. The screws shall be placed on both sides of the splice and spaced at 6" centers. The Engineer may approve other methods of splicing the sign face.

REFLECTIVE SHEETING

- All signs shall be retroreflective and constructed of sheeting meeting the color and retro-reflectivity requirements of DMS-8300 for rigid signs or DMS-8310 for roll-up signs. The web address for DMS specifications is shown on BC(1).
- White sheeting, meeting the requirements of DMS-8300 Type A, shall be used for signs with a white background.
- Orange sheeting, meeting the requirements of DMS-8300 Type B or Type C, shall be used for rigid signs with orange backgrounds.

SIGN LETTERS

- All sign letters and numbers shall be clear, and open rounded type uppercase alphabet letters as approved by the Federal Highway Administration (FHWA) and as published in the "Standard Highway Sign Design for Texas" manual. Signs, letters and numbers shall be of first class workmanship in accordance with Department Standards and Specifications.

REMOVING OR COVERING

- When sign messages may be confusing or do not apply, the signs shall be removed or completely covered.
- Long-term stationary or intermediate stationary signs installed on square metal tubing may be turned away from traffic 90 degrees when the sign message is not applicable. This technique may not be used for signs installed in the median of divided highways or near any intersections where the sign may be seen from approaching traffic.
- Signs installed on wooden skids shall not be turned at 90 degree angles to the roadway. These signs should be removed or completely covered when not required.
- When signs are covered, the material used shall be opaque, such as heavy mil black plastic, or other materials which will cover the entire sign face and maintain their opaque properties under automobile headlights at night, without damaging the sign sheeting.
- Burlap shall NOT be used to cover signs.
- Duct tape or other adhesive material shall NOT be affixed to a sign face.
- Signs and anchor stubs shall be removed and holes backfilled upon completion of work.

SIGN SUPPORT WEIGHTS

- Where sign supports require the use of weights to keep from turning over, the use of sandbags with dry, cohesionless sand should be used.
- The sandbags will be tied shut to keep the sand from spilling and to maintain a constant weight.
- Rock, concrete, iron, steel or other solid objects shall not be permitted for use as sign support weights.
- Sandbags should weigh a minimum of 35 lbs and a maximum of 50 lbs.
- Sandbags shall be made of a durable material that tears upon vehicular impact. Rubber (such as tire inner tubes) shall NOT be used.
- Rubber ballasts designed for channelizing devices should not be used for ballast on portable sign supports. Sign supports designed and manufactured with rubber bases may be used when shown on the CWZTCD list.
- Sandbags shall only be placed along or laid over the base supports of the traffic control device and shall not be suspended above ground level or hung with rope, wire, chains or other fasteners. Sandbags shall be placed along the length of the skids to weigh down the sign support.
- Sandbags shall NOT be placed under the skid and shall not be used to level sign supports placed on slopes.

FLAGS ON SIGNS

- Flags may be used to draw attention to warning signs. When used the flag shall be 16 inches square or larger and shall be orange or fluorescent red-orange in color. Flags shall not be allowed to cover any portion of the sign face.

STOP/SLOW PADDLES

- STOP/SLOW paddles are the primary method to control traffic by flaggers. The STOP/SLOW paddle size should be 24" x 24" as detailed below.
- When used at night, the STOP/SLOW paddle shall be retroreflectORIZED.
- STOP/SLOW paddles may be attached to a staff with a minimum length of 6' to the bottom of the sign.
- Any lights incorporated into the STOP or SLOW paddle faces shall only be as specifically described in Section 6E.03 Hand Signaling Devices in the TMUTCD.

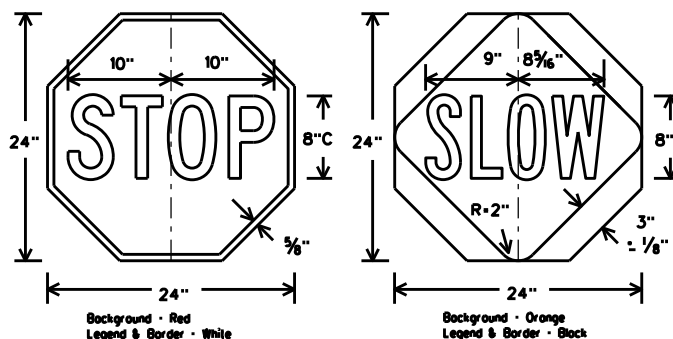

CONTRACTOR REQUIREMENTS FOR MAINTAINING PERMANENT SIGNS WITHIN THE PROJECT LIMITS

- Permanent signs are used to give notice of traffic laws or regulations, call attention to conditions that are potentially hazardous to traffic operations, show route designations, destinations, directions, distances, services, points of interest, and other geographical, recreational, or cultural information. Drivers proceeding through a work zone need the same, if not better route guidance as normally installed on a roadway without construction.
- When permanent regulatory or warning signs conflict with work zone conditions, remove or cover the permanent signs until the permanent sign message matches the roadway condition.
- When existing permanent signs are moved and relocated due to construction purposes, they shall be visible to motorists at all times.
- If existing signs are to be relocated on their original supports, they shall be installed on crashworthy bases as shown on the SMD Standard sheets. The signs shall meet the required mounting heights shown on the BC Sheets or the SMD Standards. This work should be paid for under the appropriate pay item for relocating existing signs.
- If permanent signs are to be removed and relocated using temporary supports, the Contractor shall use crashworthy supports as shown on the BC sheets or the CWZTCD. The signs shall meet the required mounting heights shown on the BC Sheets or the SMD Standards during construction. This work should be paid for under the appropriate pay item for relocating existing signs.
- Any sign or traffic control device that is struck or damaged by the Contractor or his/her construction equipment shall be replaced as soon as possible by the Contractor to ensure proper guidance for the motorists. This will be subsidiary to Item 502.

DISCLAIMER: The use of this standard is governed by the "Texas Engineering Practice Act". No warranty of any kind is made by TxDOT for any purpose whatsoever. TxDOT assumes no responsibility for the conversion of this standard to other formats or for incorrect results or damages resulting from its use.

DISCLAIMER: The use of this standard is governed by the "Texas Engineering Practice Act". No warranty of any kind is made by TxDOT for any purpose whatsoever. TxDOT assumes no responsibility for the conversion of this standard to other formats or for incorrect results or damages resulting from its use.

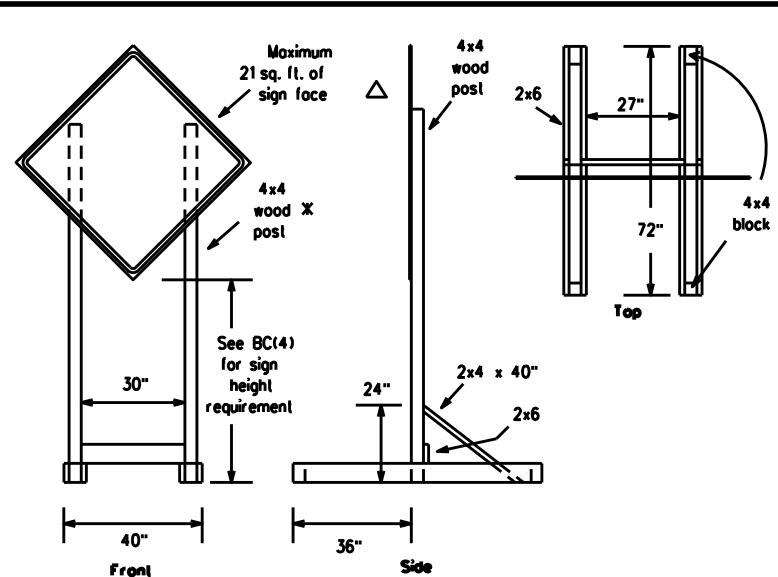

SKID MOUNTED WOOD SIGN SUPPORTS

LONG/INTERMEDIATE TERM STATIONARY - PORTABLE SKID MOUNTED SIGN SUPPORTS □

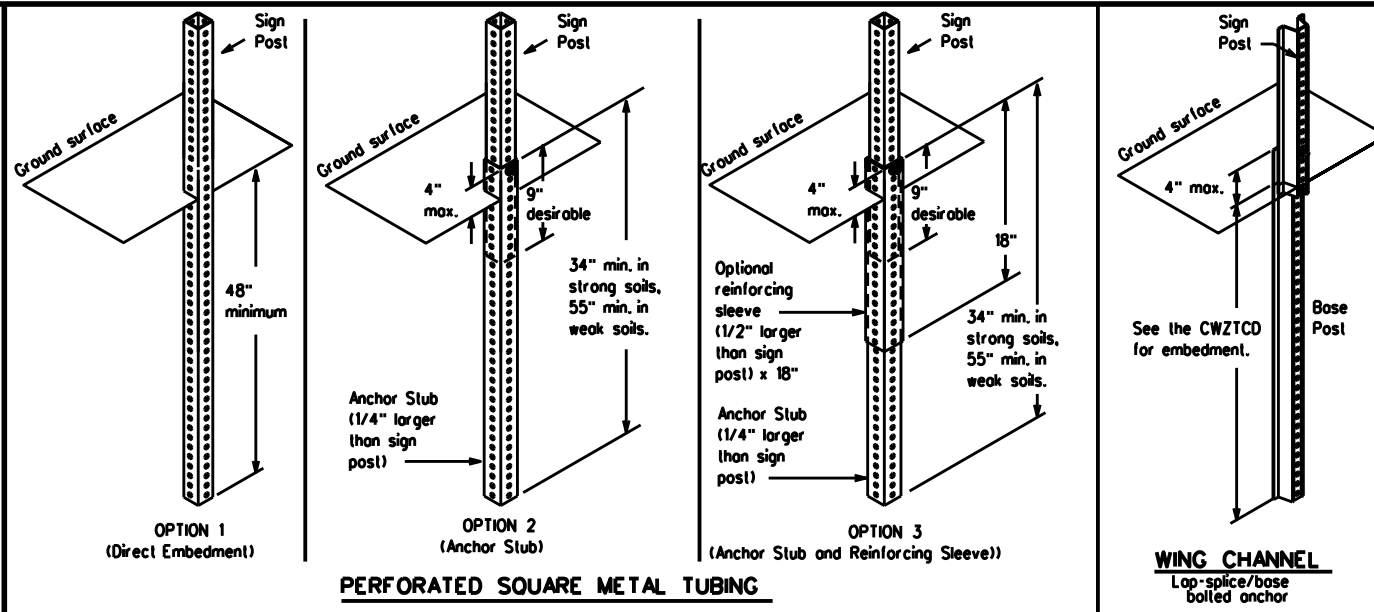
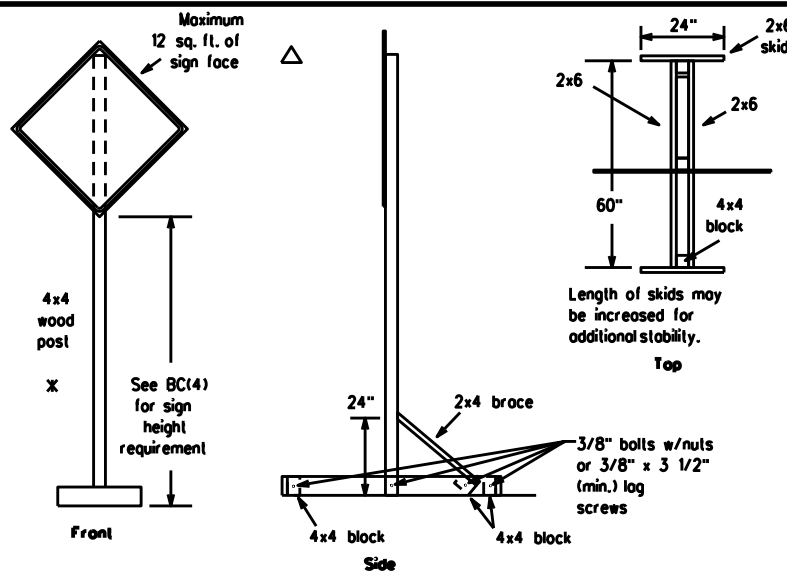

GROUND MOUNTED SIGN SUPPORTS

Refer to the CWZTCD and the manufacturer's installation procedure for each type sign support. The maximum sign square footage shall adhere to the manufacturer's recommendation. Two post installations can be used for larger signs.

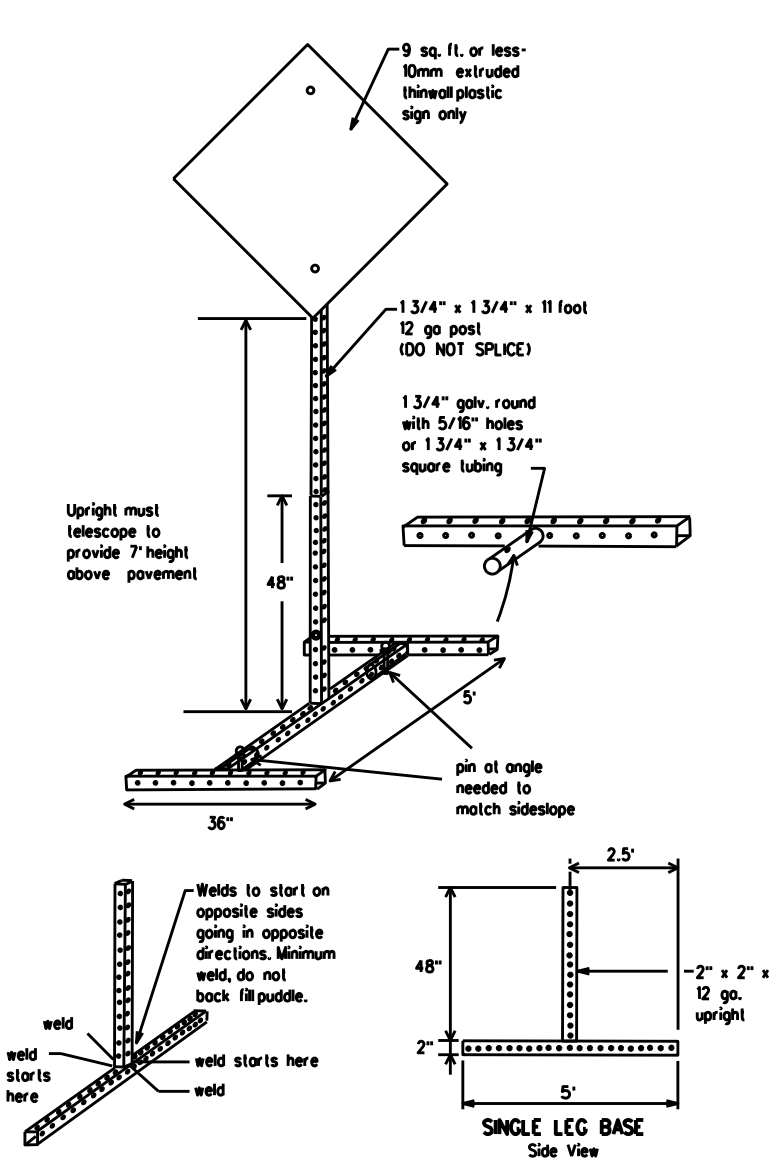

SKID MOUNTED PERFORATED SQUARE STEEL TUBING SIGN SUPPORTS

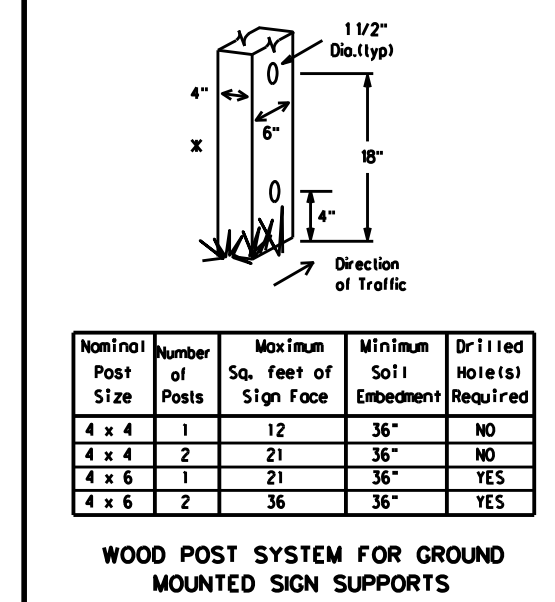
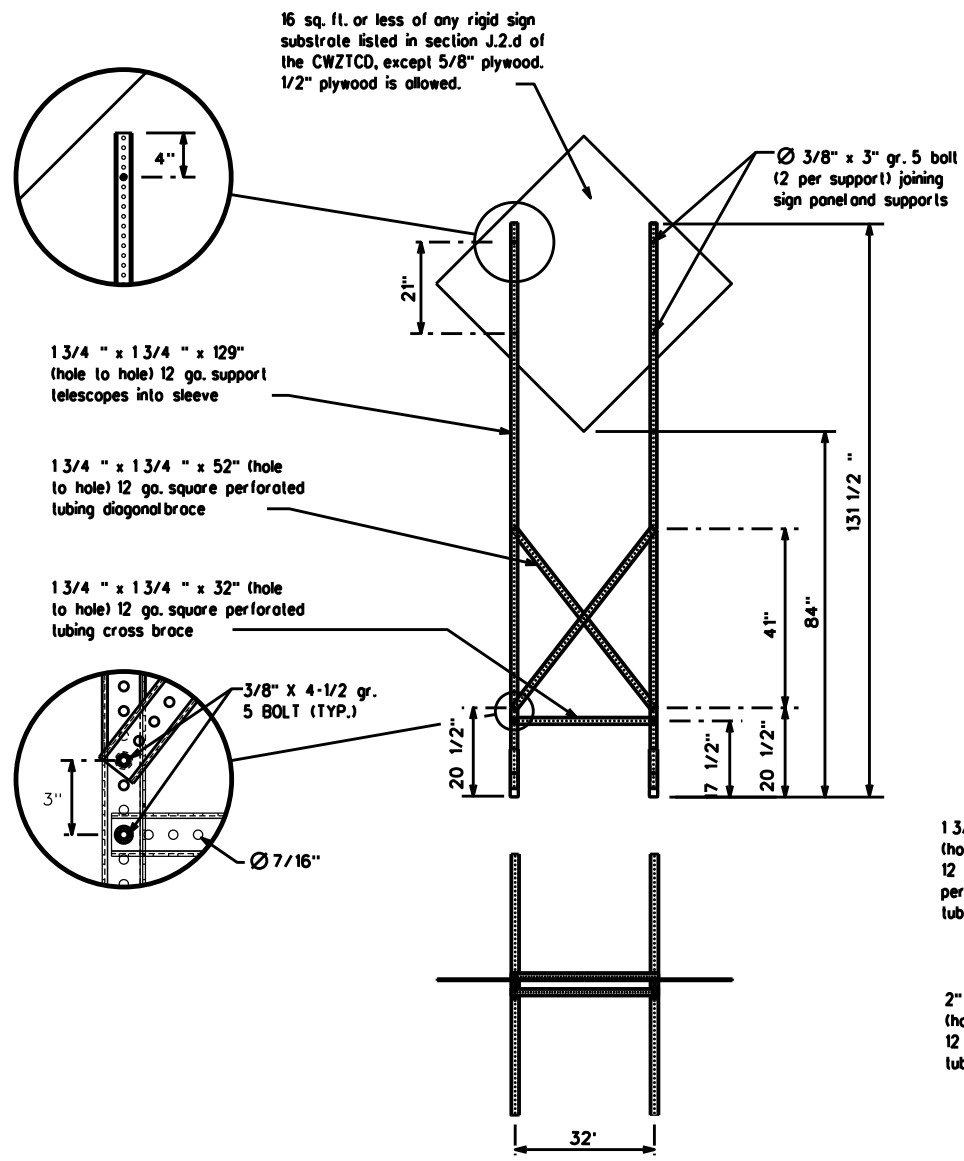

Nominal Post Size	Number of Posts	Maximum Sq. feet of Sign Face	Minimum Soil Embedment	Drilled Holes(s) Required
4 x 4	1	12	36"	NO
4 x 4	2	21	36"	NO
4 x 6	1	21	36"	YES
4 x 6	2	36	36"	YES

WOOD POST SYSTEM FOR GROUND MOUNTED SIGN SUPPORTS

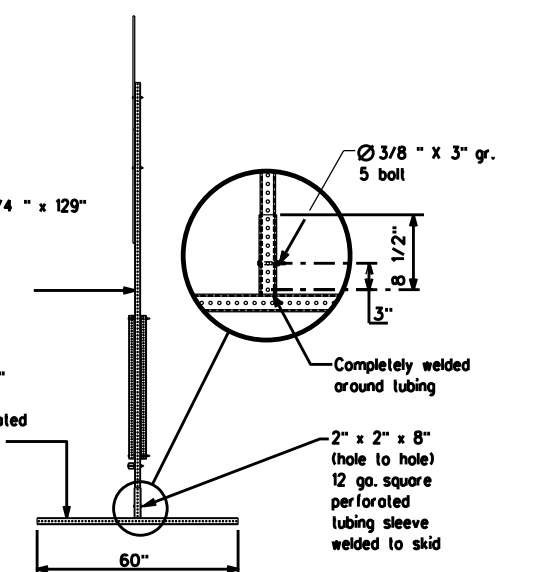

WEDGE ANCHORS

Both steel and plastic Wedge Anchor Systems as shown on the SMD Standard Sheets may be used as temporary sign supports for signs up to 10 square feet of sign face. They may be set in concrete or in sturdy soils if approved by the Engineer. (See web address for "Traffic Engineering Standard Sheets" on BC(1)).

OTHER DESIGNS

MORE DETAILS OF APPROVED LONG/INTERMEDIATE AND SHORT TERM SUPPORTS CAN BE FOUND ON THE CWZTCD LIST. SEE BC(1) FOR WEBSITE LOCATION.

GENERAL NOTES

1. Nails may be used in the assembly of wooden sign supports, but 3/8" bolts with nuts or 3/8" x 3 1/2" log screws must be used on every joint for final connection.
2. No more than 2 sign posts shall be placed within a 7 ft. circle, except for specific materials noted on the CWZTCD List.
3. When project is completed, all sign supports and foundations shall be removed from the project site. This will be considered subsidiary to Item 502.

- See BC(4) for definition of "Work Duration."
- ✕ Wood sign posts MUST be one piece. Splicing will NOT be allowed. Posts shall be painted white.
- △ See the CWZTCD for the type of sign substrate that can be used for each approved sign support.

SHEET 5 OF 12



BARRICADE AND CONSTRUCTION TYPICAL SIGN SUPPORT

BC(5)-14

FILE: bc-14.dgn	DN: TxDOT	CK: TxDOT	DW: TxDOT	CK: TxDOT
© TxDOT November 2002	CONT	SECT	JOB	HIGHWAY
REVISIONS				
9-07 8-14				
7-13	DIST	COUNTY		SHEET NO.
				30

DATE: FILE:

WHEN NOT IN USE, REMOVE THE PCMS FROM THE RIGHT-OF-WAY OR PLACE THE PCMS BEHIND BARRIER OR GUARDRAIL WITH SIGN PANEL TURNED PARALLEL TO TRAFFIC

RECOMMENDED PHASES AND FORMATS FOR PCMS MESSAGES DURING ROADWORK ACTIVITIES

(The Engineer may approve other messages not specifically covered here.)

PORTABLE CHANGEABLE MESSAGE SIGNS

- The Engineer/Inspector shall approve all messages used on portable changeable message signs (PCMS).
- Messages on PCMS should contain no more than 8 words (about four to eight characters per word), not including simple words such as "TO," "FOR," "AT," etc.
- Messages should consist of a single phase, or two phases that alternate. Three-phase messages are not allowed. Each phase of the message should convey a single thought, and must be understood by itself.
- Use the word "EXIT" to refer to an exit ramp on a freeway; i.e., "EXIT CLOSED." Do not use the term "RAMP."
- Always use the route or interstate designation (IH, US, SH, FM) along with the number when referring to a roadway.
- When in use the bottom of a stationary PCMS message panel should be a minimum 7 feet above the roadway, where possible.
- The message term "WEEKEND" should be used only if the work is to start on Saturday morning and end by Sunday evening at midnight. Actual days and hours of work should be displayed on the PCMS if work is to begin on Friday evening and/or continue into Monday morning.
- The Engineer/Inspector may select one of two options which are available for displaying a two-phase message on a PCMS. Each phase may be displayed for either four seconds each or for three seconds each.
- Do not "flash" messages or words included in a message. The message should be steady burn or continuous while displayed.
- Do not present redundant information on a two-phase message; i.e., keeping two lines of the message the same and changing the third line.
- Do not use the word "Danger" in message.
- Do not display the message "LANES SHIFT LEFT" or "LANES SHIFT RIGHT" on a PCMS. Drivers do not understand the message.
- Do not display messages that scroll horizontally or vertically across the face of the sign.
- The following table lists abbreviated words and two-word phrases that are acceptable for use on a PCMS. Both words in a phrase must be displayed together. Words or phrases not on this list should not be abbreviated, unless shown in the TMUTCD.
- PCMS character height should be at least 18 inches for trailer mounted units. They should be visible from at least 1/2 (.5) mile and the text should be legible from at least 600 feet at night and 800 feet in daylight. Truck mounted units must have a character height of 10 inches and must be legible from at least 400 feet.
- Each line of text should be centered on the message board rather than left or right justified.
- If disabled, the PCMS should default to an illegible display that will not alarm motorists and will only be used to alert workers that the PCMS has malfunctioned. A pattern such as a series of horizontal solid bars is appropriate.

DISCLAIMER: The use of this standard is governed by the "Texas Engineering Practice Act." No warranty of any kind is made by TxDOT for any purpose whatsoever. TxDOT assumes no responsibility for the conversion of this standard to other formats or for incorrect results or damages resulting from its use.

Phase 1: Condition Lists

Road/Lane/Ramp Closure List

FREEWAY CLOSED X MILE
ROAD CLOSED AT SH XXX
ROAD CLSD AT FM XXXX
RIGHT X LANES CLOSED
CENTER LANE CLOSED
NIGHT LANE CLOSURES
VARIOUS LANES CLOSED
EXIT CLOSED
MALL DRIVEWAY CLOSED
XXXXXXXX BLVD CLOSED

Other Condition List

FRONTAGE ROAD CLOSED
SHOULDER CLOSED XXX FT
RIGHT LN CLOSED XXX FT
RIGHT X LANES OPEN
DAYTIME LANE CLOSURES
I-XX SOUTH EXIT CLOSED
EXIT XXX CLOSED X MILE
RIGHT LN TO BE CLOSED
X LANES CLOSED TUE - FRI

* LANES SHIFT in Phase 1 must be used with STAY IN LANE in Phase 2.

Phase 2: Possible Component Lists

Action to Take/Effect on Travel List

MERGE RIGHT
DETOUR NEXT X EXITS
USE EXIT XXX
STAY ON US XXX SOUTH
TRUCKS USE US XXX N
WATCH FOR TRUCKS
EXPECT DELAYS
REDUCE SPEED XXX FT
USE OTHER ROUTES
STAY IN LANE

Location List

AT FM XXXX
BEFORE RAILROAD CROSSING
NEXT X MILES
PAST US XXX EXIT
XXXXXXXX TO XXXXXXX
US XXX TO FM XXXX

Warning List

SPEED LIMIT XX MPH
MAXIMUM SPEED XX MPH
MINIMUM SPEED XX MPH
ADVISORY SPEED XX MPH
RIGHT LANE EXIT
USE CAUTION
DRIVE SAFELY
DRIVE WITH CARE

** Advance Notice List

TUE-FRI XX AM-X PM
APR XX-XX X PM-X AM
BEGINS MONDAY
BEGINS MAY XX
MAY X-X XX PM-XX AM
NEXT FRI-SUN
XX AM TO XX PM
NEXT TUE AUG XX
TONIGHT XX PM-XX AM

** See Application Guidelines Note 6.

WORD OR PHRASE	ABBREVIATION	WORD OR PHRASE	ABBREVIATION
Access Road	ACCS RD	Major	MAJ
Alternate	ALT	Miles	MI
Avenue	AVE	Miles Per Hour	MPH
Best Route	BEST RTE	Minor	MNR
Boulevard	BLVD	Monday	MON
Bridge	BRDG	Normal	NORM
Canal	CANT	North	N
Center	CTR	Northbound (route) N	
Construction Ahead	CONST AHD	Parking	PKING
CROSSING	XING	Road	RD
Detour Route	DETOUR RTE	Right Lane	RT LN
Do Not	DONT	Saturday	SAT
East	E	Service Road	SERV RD
Eastbound (route) E		Shoulder	SHLDR
Emergency	EMER	Slippery	SLIP
Emergency Vehicle	EMER VEH	South	S
Entrance, Enter	ENT	Southbound (route) S	
Express Lane	EXP LN	Speed	SPD
Expressway	EXPWY	Street	ST
XXXX Feet	XXXX FT	Sunday	SUN
Fog Ahead	FOG AHD	Telephone	PHONE
Freeway	FRWY, FWY	Temporary	TEMP
Freeway Blocked	FWY BLKD	Thursday	THURS
Friday	FRI	To Downtown	TO DWNTN
Hazardous Driving	HAZ DRIVING	Traffic	TRAF
Hazardous Material	HAZMAT	Travelers	TRVLR
High Occupancy Vehicle	HOV	Tuesday	TUES
Highway	HWY	Time Minutes	TIME MIN
Hour(s)	HR, HRS	Upper Level	UPR LEVEL
Information	INFO	Vehicles (s)	VEH, VEHs
It Is	ITS	Warning	WARN
Junction	JCT	Wednesday	WED
Left	LFT	Weight Limit	WT LIMIT
Left Lane	LFT LN	West	W
Lane Closed	LN CLOSED	Westbound (route) W	
Lower Level	LWR LEVEL	Wet Pavement	WET PVMT
Maintenance	MAINT	Will Not	WONT

Roadway designation = IH-number, US-number, SH-number, FM-number

APPLICATION GUIDELINES

- Only 1 or 2 phases are to be used on a PCMS.
- The 1st phase (or both) should be selected from the "Road/Lane/Ramp Closure List" and the "Other Condition List".
- A 2nd phase can be selected from the "Action to Take/Effect on Travel, Location, General Warning, or Advance Notice Phase Lists".
- A Location Phase is necessary only if a distance or location is not included in the first phase selected.
- If two PCMS are used in sequence, they must be separated by a minimum of 1000 ft. Each PCMS should be limited to two phases, and should be understandable by themselves.
- For advance notice, when the current date is within seven days of the actual work date, calendar days should be replaced with days of the week. Advance notification should typically be for no more than one week prior to the work.

WORDING ALTERNATIVES

- The words RIGHT, LEFT and ALL can be interchanged as appropriate.
- Roadway designations IH, US, SH, FM and LP can be interchanged as appropriate.
- EAST, WEST, NORTH and SOUTH (or abbreviations E, W, N and S) can be interchanged as appropriate.
- Highway names and numbers replaced as appropriate.
- ROAD, HIGHWAY and FREEWAY can be interchanged as needed.
- AHEAD may be used instead of distances if necessary.
- FT and M, MILE and MILES interchanged as appropriate.
- AT, BEFORE and PAST interchanged as needed.
- Distances or AHEAD can be eliminated from the message if a location phase is used.

PCMS SIGNS WITHIN THE R.O.W. SHALL BE BEHIND GUARDRAIL OR CONCRETE BARRIER OR SHALL HAVE A MINIMUM OF FOUR (4) PLASTIC DRUMS PLACED PERPENDICULAR TO TRAFFIC ON THE UPSTREAM SIDE OF THE PCMS, WHEN EXPOSED TO ONE DIRECTION OF TRAFFIC. WHEN EXPOSED TO TWO WAY TRAFFIC, THE FOUR DRUMS SHOULD BE PLACED WITH ONE DRUM AT EACH OF THE FOUR CORNERS OF THE UNIT.

FULL MATRIX PCMS SIGNS

- When Full Matrix PCMS signs are used, the character height and legibility/visibility requirements shall be maintained as listed in Note 15 under "PORTABLE CHANGEABLE MESSAGE SIGNS" above.
- When symbol signs, such as the "Flogger Symbol" (CW20-7) are represented graphically on the Full Matrix PCMS sign and, with the approval of the Engineer, it shall maintain the legibility/visibility requirement listed above.
- When symbol signs are represented graphically on the Full Matrix PCMS, they shall only supplement the use of the static sign represented, and shall not substitute for, or replace that sign.
- A full matrix PCMS may be used to simulate a flashing arrow board provided it meets the visibility, flash rate and dimming requirements on BC(7), for the same size arrow.

SHEET 6 OF 12



BARRICADE AND CONSTRUCTION PORTABLE CHANGEABLE MESSAGE SIGN (PCMS)

BC(6)-14

FILE: bc-14.dgn	DN: TxDOT	CK: TxDOT	DW: TxDOT	CK: TxDOT
© TxDOT November 2002	CONT	SECT	JOB	HIGHWAY
REVISIONS				
9-07 8-14	DIST	COUNTY	SHEET NO.	
7-13			31	

DISCLAIMER: The use of this standard is governed by the "Texas Engineering Practice Act". No warranty of any kind is made by TxDOT for any purpose whatsoever. TxDOT assumes no responsibility for the conversion of this standard to other formats or for incorrect results or damages resulting from its use.

- Barrier Reflectors shall be pre-qualified, and conform to the color and reflectivity requirements of DMS-8600. A list of prequalified Barrier Reflectors can be found at the Material Producer List web address shown on BC(1).
- Color of Barrier Reflectors shall be as specified in the TMUTCD. The cost of the reflectors shall be considered subsidiary to Item 512.

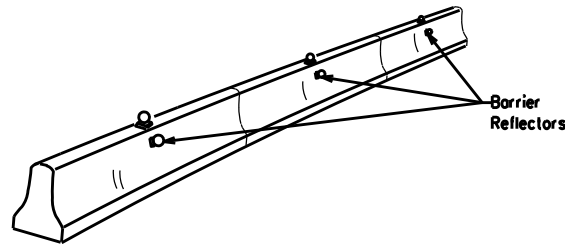

CONCRETE TRAFFIC BARRIER (CTB)

- Where traffic is on one side of the CTB, two (2) Barrier Reflectors shall be mounted in approximately the midsection of each section of CTB. An alternate mounting location is uniformly spaced at one end of each CTB. This will allow for attachment of a barrier grapple without damaging the reflector. The Barrier Reflector mounted on the side of the CTB shall be located directly below the reflector mounted on top of the barrier, as shown in the detail above.
- Where CTB separates two-way traffic, three barrier reflectors shall be mounted on each section of CTB. The reflector unit on top shall have two yellow reflective faces (Bi-Directional) while the reflectors on each side of the barrier shall have one yellow reflective face, as shown in the detail above.
- When CTB separates traffic traveling in the same direction, no barrier reflectors will be required on top of the CTB.
- Barrier Reflector units shall be yellow or white in color to match the edge line being supplemented.
- Maximum spacing of Barrier Reflectors is forty (40) feet.
- Pavement markers or temporary flexible-reflective roadway marker tabs shall NOT be used as CTB delineation.
- Attachment of Barrier Reflectors to CTB shall be per manufacturer's recommendations.
- Missing or damaged Barrier Reflectors shall be replaced as directed by the Engineer.
- Single slope barriers shall be delineated as shown on the above detail.

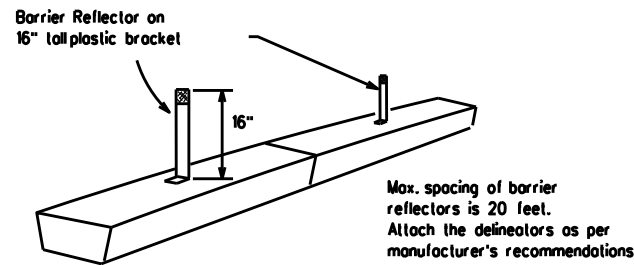

LOW PROFILE CONCRETE BARRIER (LPCB)

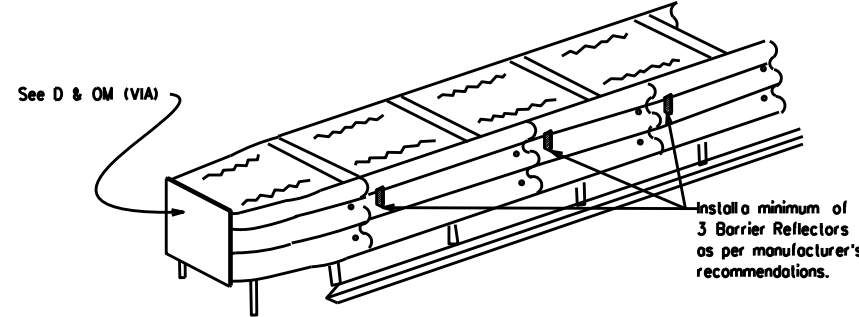

DELINEATION OF END TREATMENTS

END TREATMENTS FOR CTB'S USED IN WORK ZONES

End treatments used on CTB's in work zones shall meet crashworthy standards as defined in the National Cooperative Highway Research Report 350. Refer to the CWZTCD List for approved end treatments and manufacturers.

BARRIER REFLECTORS FOR CONCRETE TRAFFIC BARRIER AND ATTENUATORS

WARNING LIGHTS

- Warning lights shall meet the requirements of the TMUTCD.
- Warning lights shall NOT be installed on barricades.
- Type A-Low Intensity Flashing Warning Lights are commonly used with drums. They are intended to warn of or mark a potentially hazardous area. Their use shall be as indicated on this sheet and/or other sheets of the plans by the designation "FL". The Type A Warning Lights shall not be used with signs manufactured with Type B or C sheeting, meeting the requirements of Departmental Material Specification DMS-8300.
- Type-C and Type D 360 degree Steady Burn Lights are intended to be used in a series for delineation to supplement other traffic control devices. Their use shall be as indicated on this sheet and/or other sheets of the plans by the designation "SB".
- The Engineer/Inspector or the plans shall specify the location and type of warning lights to be installed on the traffic control devices.
- When required by the Engineer, the Contractor shall furnish a copy of the warning light certification. The warning light manufacturer will certify the warning lights meet the requirements of the latest ITE Purchase Specifications for Flashing and Steady-Burn Warning Lights.
- When used to delineate curves, Type-C and Type D Steady Burn Lights should only be placed on the outside of the curve, not the inside.
- The location of warning lights and warning reflectors on drums shall be as shown elsewhere in the plans.

WARNING LIGHTS MOUNTED ON PLASTIC DRUMS

- Type A flashing warning lights are intended to warn drivers that they are approaching or are in a potentially hazardous area.
- Type A random flashing warning lights are not intended for delineation and shall not be used in a series.
- A series of sequential flashing warning lights placed on channelizing devices to form a merging taper may be used for delineation. If used, the successive flashing of the sequential warning lights should occur from the beginning of the taper to the end of the merging taper in order to identify the desired vehicle path. The rate of flashing for each light shall be 65 flashes per minute, plus or minus 10 flashes.
- Type C and D steady-burn warning lights are intended to be used in a series to delineate the edge of the travel lane on detours, on lane changes, on lane closures, and on other similar conditions.
- Type A, Type C and Type D warning lights shall be installed at locations as detailed on other sheets in the plans.
- Warning lights shall not be installed on a drum that has a sign, chevron or vertical panel.
- The maximum spacing for warning lights on drums should be identical to the channelizing device spacing.

WARNING REFLECTORS MOUNTED ON PLASTIC DRUMS AS A SUBSTITUTE FOR TYPE C (STEADY BURN) WARNING LIGHTS

- A warning reflector or approved substitute may be mounted on a plastic drum as a substitute for a Type C, steady burn warning light at the discretion of the Contractor unless otherwise noted in the plans.
- The warning reflector shall be yellow in color and shall be manufactured using a sign substrate approved for use with plastic drums listed on the CWZTCD.
- The warning reflector shall have a minimum retroreflective surface area (one-side) of 30 square inches.
- Round reflectors shall be fully reflectorized, including the area where attached to the drum.
- Square substrates must have a minimum of 30 square inches of reflectorized sheeting. They do not have to be reflectorized where it attaches to the drum.
- The side of the warning reflector facing approaching traffic shall have sheeting meeting the color and retroreflectivity requirements for DMS 8300-Type B or Type C.
- When used near two-way traffic, both sides of the warning reflector shall be reflectorized.
- The warning reflector should be mounted on the side of the handle nearest approaching traffic.
- The maximum spacing for warning reflectors should be identical to the channelizing device spacing requirements.

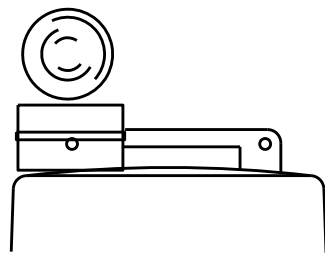

Type C Warning Light or approved substitute mounted on a drum adjacent to the travel way.

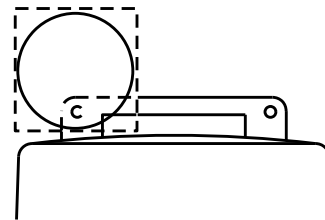

Warning reflector may be round or square. Must have a yellow reflective surface area of at least 30 square inches

Arrow Boards may be located behind channelizing devices in place for a shoulder taper or merging taper, otherwise they shall be delineated with four (4) channelizing devices placed perpendicular to traffic on the upstream side of traffic.

- The Flashing Arrow Board should be used for all lane closures on multi-lane roadways, or slow moving maintenance or construction activities on the travel lanes.
- Flashing Arrow Boards should not be used on two-lane, two-way roadways, detours, diversions or work on shoulders unless the "CAUTION" display (see detail below) is used.
- The Engineer/Inspector shall choose all appropriate signs, barricades and/or other traffic control devices that should be used in conjunction with the Flashing Arrow Board.
- The Flashing Arrow Board should be able to display the following symbols:

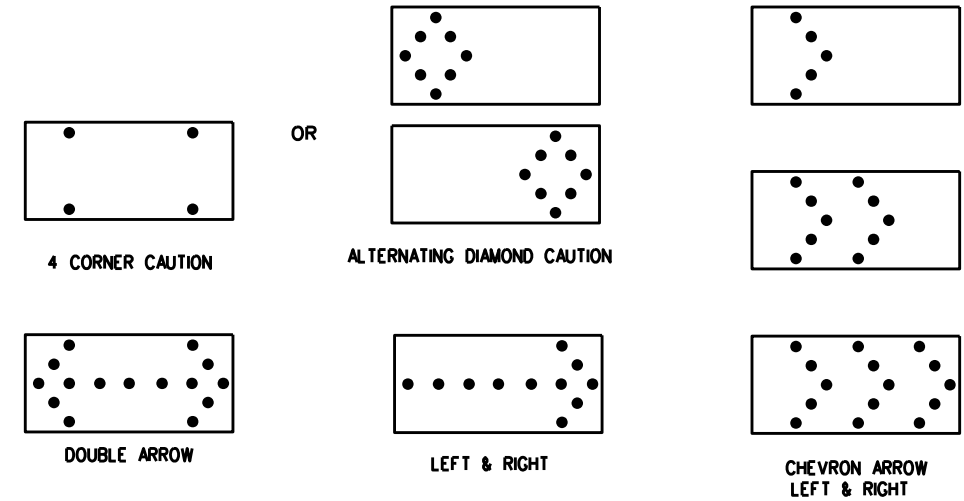

- The "CAUTION" display consists of four corner lamps flashing simultaneously, or the Alternating Diamond Caution mode as shown.
- The straight line caution display is NOT ALLOWED.
- The Flashing Arrow Board shall be capable of minimum 50 percent dimming from rated lamp voltage. The flashing rate of the lamps shall not be less than 25 nor more than 40 flashes per minute.
- Minimum lamp "on time" shall be approximately 50 percent for the flashing arrow and equal intervals of 25 percent for each sequential phase of the flashing chevron.
- The sequential arrow display is NOT ALLOWED.
- The flashing arrow display is the TxDOT standard; however, the sequential Chevron display may be used during daylight operations.
- The Flashing Arrow Board shall be mounted on a vehicle, trailer or other suitable support.
- A Flashing Arrow Board SHALL NOT BE USED to laterally shift traffic.
- A full matrix PCMS may be used to simulate a Flashing Arrow Board provided it meets visibility, flash rate and dimming requirements on this sheet for the same size arrow.
- Minimum mounting height of trailer mounted Arrow Boards should be 7 feet from roadway to bottom of panel.

REQUIREMENTS			
TYPE	MINIMUM SIZE	MINIMUM NUMBER OF PANEL LAMPS	MINIMUM VISIBILITY DISTANCE
B	30 x 60	13	3/4 mile
C	48 x 96	15	1 mile

ATTENTION
Flashing Arrow Boards shall be equipped with automatic dimming devices.

WHEN NOT IN USE, REMOVE THE ARROW BOARD FROM THE RIGHT-OF-WAY OR PLACE THE ARROW BOARD BEHIND CONCRETE TRAFFIC BARRIER OR GUARDRAIL.

FLASHING ARROW BOARDS

SHEET 7 OF 12

TRUCK-MOUNTED ATTENUATORS

- Truck-mounted attenuators (TMA) used on TxDOT facilities must meet the requirements outlined in the National Cooperative Highway Research Report No. 350 (NCHRP 350) or the Manual for Assessing Safety Hardware (MASH).
- Refer to the CWZTCD for the requirements of Level 2 or Level 3 TMAs.
- Refer to the CWZTCD for a list of approved TMAs.
- TMAs are required on freeways unless otherwise noted in the plans.
- A TMA should be used anytime that it can be positioned 30 to 100 feet in advance of the area of crew exposure without adversely affecting the work performance.
- The only reason a TMA should not be required is when a work area is spread down the roadway and the work crew is an extended distance from the TMA.



BARRICADE AND CONSTRUCTION ARROW PANEL, REFLECTORS, WARNING LIGHTS & ATTENUATOR

BC(7)-14

FILE:	bc-14.dgn	DN:	TxDOT	CK:	TxDOT	DW:	TxDOT	CK:	TxDOT
© TxDOT	November 2002	CONT	SECT	JOB	HIGHWAY				
REVISIONS									
9-07	8-14								
7-13		DIST	COUNTY			SHEET NO.			
						32			

DATE:
FILE:

GENERAL NOTES

- For long term stationary work zones on freeways, drums shall be used as the primary channelizing device.
- For intermediate term stationary work zones on freeways, drums should be used as the primary channelizing device but may be replaced in tangent sections by vertical panels, or 42" two-piece cones. In tangent sections one-piece cones may be used with the approval of the Engineer but only if personnel are present on the project at all times to maintain the cones in proper position and location.
- For short term stationary work zones on freeways, drums are the preferred channelizing device but may be replaced in tapers, transitions and tangent sections by vertical panels, two-piece cones or one-piece cones as approved by the Engineer.
- Drums and all related items shall comply with the requirements of the current version of the "Texas Manual on Uniform Traffic Control Devices" (TMUTCD) and the "Compliant Work Zone Traffic Control Devices List" (CWZTCD).
- Drums, bases, and related materials shall exhibit good workmanship and shall be free from objectionable marks or defects that would adversely affect their appearance or serviceability.
- The Contractor shall have a maximum of 24 hours to replace any plastic drums identified for replacement by the Engineer/Inspector. The replacement device must be an approved device.

GENERAL DESIGN REQUIREMENTS

Pre-qualified plastic drums shall meet the following requirements:

- Plastic drums shall be a two-piece design; the "body" of the drum shall be the top portion and the "base" shall be the bottom.
- The body and base shall lock together in such a manner that the body separates from the base when impacted by a vehicle traveling at a speed of 20 MPH or greater but prevents accidental separation due to normal handling and/or air turbulence created by passing vehicles.
- Plastic drums shall be constructed of lightweight flexible, and deformable materials. The Contractor shall NOT use metal drums or single piece plastic drums as channelization devices or sign supports.
- Drums shall present a profile that is a minimum of 18 inches in width of the 36 inch height when viewed from any direction. The height of drum unit (body installed on base) shall be a minimum of 36 inches and a maximum of 42 inches.
- The top of the drum shall have a built-in handle for easy pickup and shall be designed to drain water and not collect debris. The handle shall have a minimum of two widely spaced 9/16 inch diameter holes to allow attachment of a warning light, warning reflector unit or approved compliant sign.
- The exterior of the drum body shall have a minimum of four alternating orange and white retroreflective circumferential stripes not less than 4 inches nor greater than 8 inches in width. Any non-reflectORIZED space between any two adjacent stripes shall not exceed 2 inches in width.
- Bases shall have a maximum width of 36 inches, a maximum height of 4 inches, and a minimum of two footholds of sufficient size to allow base to be held down while separating the drum body from the base.
- Plastic drums shall be constructed of ultra-violet stabilized, orange, high-density polyethylene (HDPE) or other approved material.
- Drum body shall have a maximum unballasted weight of 11 lbs.
- Drum and base shall be marked with manufacturer's name and model number.

RETROREFLECTIVE SHEETING

- The stripes used on drums shall be constructed of sheeting meeting the color and retroreflectivity requirements of Departmental Materials Specification DMS-8300, "Sign Face Materials." Type A reflective sheeting shall be supplied unless otherwise specified in the plans.
- The sheeting shall be suitable for use on and shall adhere to the drum surface such that, upon vehicular impact, the sheeting shall remain adhered in-place and exhibit no delaminating, cracking, or loss of retroreflectivity other than that loss due to abrasion of the sheeting surface.

BALLAST

- Unballasted bases shall be large enough to hold up to 50 lbs. of sand. This base, when filled with the ballast material, should weigh between 35 lbs (minimum) and 50 lbs (maximum). The ballast may be sand in one to three sandbags separate from the base, sand in a sand-filled plastic base, or other ballasting devices as approved by the Engineer. Stacking of sandbags will be allowed, however height of sandbags above pavement surface may not exceed 12 inches.
- Bases with built-in ballast shall weigh between 40 lbs. and 50 lbs. Built-in ballast can be constructed of an integral crumb rubber base or a solid rubber base.
- Recycled truck tire sidewalls may be used for ballast on drums approved for this type of ballast on the CWZTCD list.
- The ballast shall not be heavy objects, water, or any material that would become hazardous to motorists, pedestrians, or workers when the drum is struck by a vehicle.
- When used in regions susceptible to freezing, drums shall have drainage holes in the bottoms so that water will not collect and freeze becoming a hazard when struck by a vehicle.
- Ballast shall not be placed on top of drums.
- Adhesives may be used to secure base of drums to pavement.

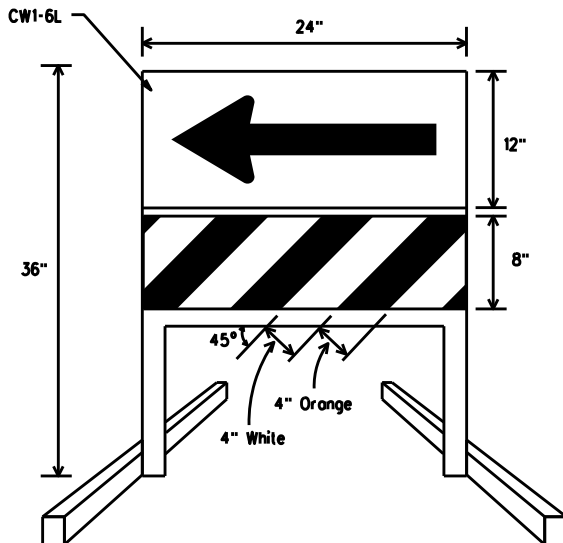
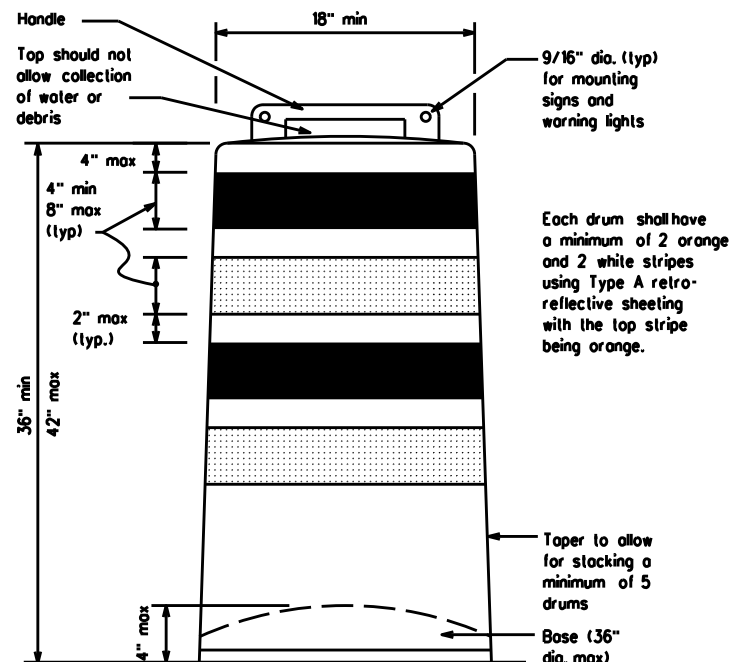

DIRECTION INDICATOR BARRICADE

- The Direction Indicator Barricade may be used in tapers, transitions, and other areas where specific directional guidance to drivers is necessary.
- If used, the Direction Indicator Barricade should be used in series to direct the driver through the transition and into the intended travel lane.
- The Direction Indicator Barricade shall consist of One-Direction Large Arrow (CW1-6) sign in the size shown with a black arrow on a background of Type B or Type C Orange retroreflective sheeting above a rail with Type A retroreflective sheeting in alternating 4" white and orange stripes sloping downward at an angle of 45 degrees in the direction road users are to pass. Sheeting types shall be as per DMS 8300.
- Double arrows on the Direction Indicator Barricade will not be allowed.
- Approved manufacturers are shown on the CWZTCD List. Ballast shall be as approved by the manufacturers instructions.

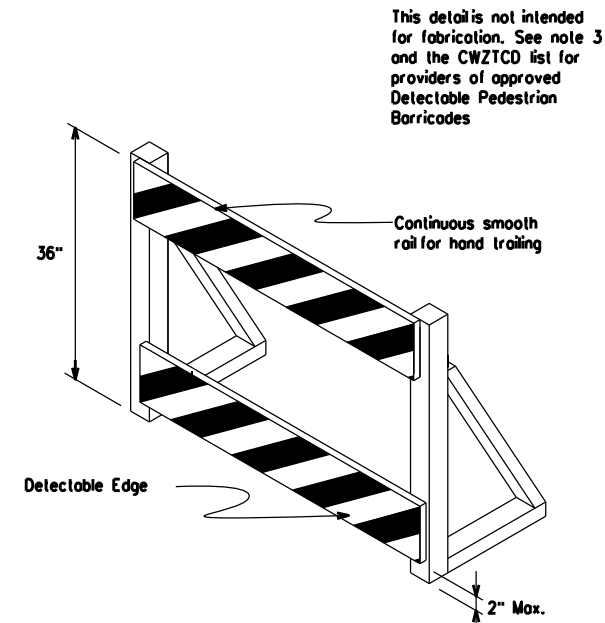

DETECTABLE PEDESTRIAN BARRICADES

- When existing pedestrian facilities are disrupted, closed, or relocated in a TTC zone, the temporary facilities shall be detectable and include accessibility features consistent with the features present in the existing pedestrian facility.
- Where pedestrians with visual disabilities normally use the closed sidewalk, a device that is detectable by a person with a visual disability traveling with the aid of a long cane shall be placed across the full width of the closed sidewalk.
- Detectable pedestrian barricades similar to the one pictured above, longitudinal channelizing devices, some concrete barriers, and wood or chain link fencing with a continuous detectable edging can satisfactorily delineate a pedestrian path.
- Tape, rope, or plastic chain strung between devices are not detectable, do not comply with the design standards in the "Americans with Disabilities Act Accessibility Guidelines for Buildings and Facilities (ADAAG)" and should not be used as a control for pedestrian movements.
- Warning lights shall not be attached to detectable pedestrian barricades.
- Detectable pedestrian barricades may use 8" nominal barricade rails as shown on BC(10) provided that the top rail provides a smooth continuous rail suitable for hand trailing with no splinters, burrs, or sharp edges.

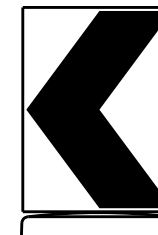

18" x 24" Sign
(Maximum Sign Dimension)
Chevron CW1-8, Opposing Traffic Lane Divider, Driveway sign D70a, Keep Right R4 series or other signs as approved by Engineer

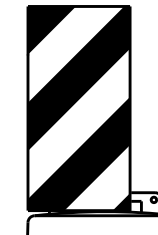

12" x 24" Vertical Panel
mount with diagonals sloping down towards travel way

Plywood, Aluminum or Metal sign substrates shall NOT be used on plastic drums

SIGNS, CHEVRONS, AND VERTICAL PANELS MOUNTED ON PLASTIC DRUMS

- Signs used on plastic drums shall be manufactured using substrates listed on the CWZTCD.
- Chevrons and other work zone signs with an orange background shall be manufactured with Type B or Type C Orange sheeting meeting the color and retroreflectivity requirements of DMS-8300, "Sign Face Material," unless otherwise specified in the plans.
- Vertical Panels shall be manufactured with orange and white sheeting meeting the requirements of DMS-8300 Type A Diagonal stripes on Vertical Panels shall slope down toward the intended traveled lane.
- Other sign messages (text or symbolic) may be used as approved by the Engineer. Sign dimensions shall not exceed 18 inches in width or 24 inches in height, except for the R9 series signs discussed in note 8 below.
- Signs shall be installed using a 1/2 inch bolt (nominal) and nut, two washers, and one locking washer for each connection.
- Mounting bolts and nuts shall be fully engaged and adequately torqued. Bolts should not extend more than 1/2 inch beyond nuts.
- Chevrons may be placed on drums on the outside of curves, on merging tapers or on shifting tapers. When used in these locations they may be placed on every drum or spaced not more than on every third drum. A minimum of three (3) should be used at each location called for in the plans.
- R9-9, R9-10, R9-11 and R9-11a Sidewalk Closed signs which are 24 inches wide may be mounted on plastic drums, with approval of the Engineer.

BARRICADE AND CONSTRUCTION CHANNELIZING DEVICES

BC(8)-14

FILE: bc-14.dgn	DN: TxDOT	CK: TxDOT	DW: TxDOT	CK: TxDOT
© TxDOT November 2002	CONT	SECT	JOB	HIGHWAY
REVISIONS				
4-03 7-13	DIST	COUNTY	SHEET NO.	
9-07 8-14			33	

DISCLAIMER: The use of this standard is governed by the "Texas Engineering Practice Act". No warranty of any kind is made by TxDOT for any purpose whatsoever. TxDOT assumes no responsibility for the conversion of this standard to other formats or for incorrect results or damages resulting from its use.

DATE: FILE:

DISCLAIMER: The use of this standard is governed by the "Texas Engineering Practice Act". No warranty of any kind is made by TxDOT for any purpose whatsoever. TxDOT assumes no responsibility for the conversion of this standard to other formats or for incorrect results or damages resulting from its use.

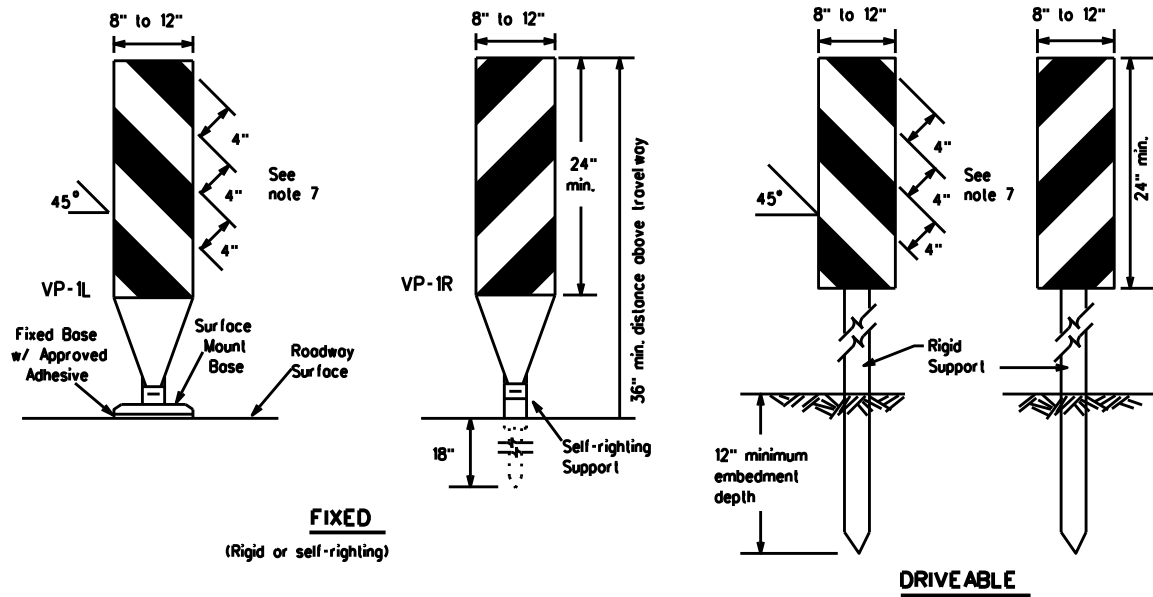

- Vertical Panels (VP's) are normally used to channelize traffic or divide opposing lanes of traffic.
- VP's may be used in daytime or nighttime situations. They may be used at the edge of shoulder drop-offs and other areas such as lane transitions where positive daytime and nighttime delineation is required. The Engineer/Inspector shall refer to the Roadway Design Manual Appendix B "Treatment of Pavement Drop-offs in Work Zones" for additional guidelines on the use of VP's for drop-offs.
- VP's should be mounted back to back if used at the edge of cuts adjacent to two-way two lane roadways. Stripes are to be reflective orange and reflective white and should always slope downward toward the travel lane.
- VP's used on expressways and freeways or other high speed roadways, may have more than 270 square inches of retroreflective area facing traffic.
- Self-righting supports are available with portable base. See "Compliant Work Zone Traffic Control Devices List" (CWZTCD).
- Sheeting for the VP's shall be retroreflective Type A conforming to Departmental Material Specification DMS-8300, unless noted otherwise.
- Where the height of reflective material on the vertical panels is 36 inches or greater, a panel stripe of 6 inches shall be used.

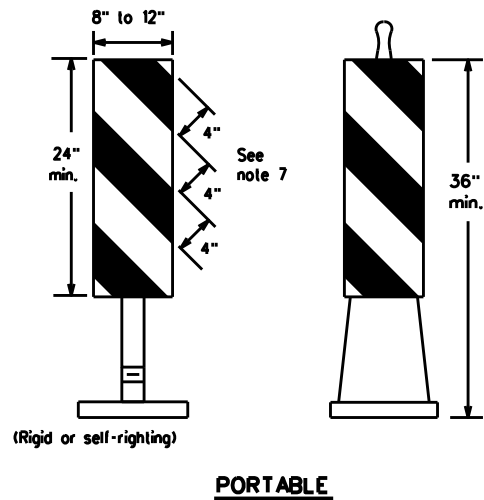

VERTICAL PANELS (VPs)

- Opposing Traffic Lane Dividers (OTLD) are delineation devices designed to convert a normal one-way roadway section to two-way operation. OTLD's are used on temporary centerlines. The upward and downward arrows on the sign's face indicate the direction of traffic on either side of the divider. The base is secured to the pavement with an adhesive or rubber weight to minimize movement caused by a vehicle impact or wind gust.
- The OTLD may be used in combination with 42" cones or VP's.
- Spacing between the OTLD shall not exceed 500 feet. 42" cones or VP's placed between the OTLD's should not exceed 100 foot spacing.
- The OTLD shall be orange with a black non-reflective legend. Sheeting for the OTLD shall be retroreflective Type B or Type C conforming to Departmental Material Specification DMS-8300, unless noted otherwise. The legend shall meet the requirements of DMS-8300.

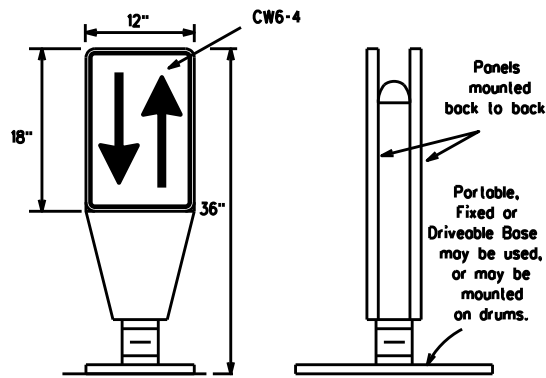

OPPOSING TRAFFIC LANE DIVIDERS (OTLD)

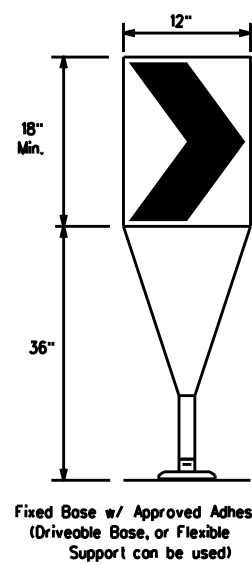

- The chevron shall be a vertical rectangle with a minimum size of 12 by 18 inches.
- Chevrons are intended to give notice of a sharp change of alignment with the direction of travel and provide additional emphasis and guidance for vehicle operators with regard to changes in horizontal alignment of the roadway.
- Chevrons, when used, shall be erected on the outside of a sharp curve or turn, or on the far side of an intersection. They shall be in line with and at right angles to approaching traffic. Spacing should be such that the motorist always has three in view, until the change in alignment eliminates its need.
- To be effective, the chevron should be visible for at least 500 feet.
- Chevrons shall be orange with a black nonreflective legend. Sheeting for the chevron shall be retroreflective Type B or Type C conforming to Departmental Material Specification DMS-8300, unless noted otherwise. The legend shall meet the requirements of DMS-8300.
- For Long Term Stationary use on tapers or transitions on freeways and divided highways self-righting chevrons may be used to supplement plastic drums but not to replace plastic drums.

CHEVRONS

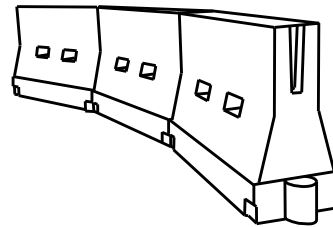

LONGITUDINAL CHANNELIZING DEVICES (LCD)

- LCDs are crashworthy, lightweight, deformable devices that are highly visible, have good target value and can be connected together. They are not designed to contain or redirect a vehicle on impact.
- LCDs may be used instead of a line of cones or drums.
- LCDs shall be placed in accordance to application and installation requirements specific to the device, and used only when shown on the CWZTCD list.
- LCDs should not be used to provide positive protection for obstacles, pedestrians or workers.
- LCDs shall be supplemented with retroreflective delineation as required for temporary barriers on BC(7) when placed roughly parallel to the travel lanes.
- LCDs used as barricades placed perpendicular to traffic should have at least one row of reflective sheeting meeting the requirements for barricade rails as shown on BC(10) placed near the top of the LCD along the full length of the device.

WATER BALLASTED SYSTEMS USED AS BARRIERS

- Water ballasted systems used as barriers shall not be used solely to channelize road users, but also to protect the work space per the appropriate NCHRP 350 crashworthiness requirements based on roadway speed and barrier application.
- Water ballasted systems used to channelize vehicular traffic shall be supplemented with retroreflective delineation or channelizing devices to improve daytime/nighttime visibility. They may also be supplemented with pavement markings.
- Water ballasted systems used as barriers shall be placed in accordance to application and installation requirements specific to the device, and used only when shown on the CWZTCD list.
- Water ballasted systems used as barriers should not be used for a merging taper except in low speed (less than 45 MPH) urban areas. When used on a taper in a low speed urban area, the taper shall be delineated and the taper length should be designed to optimize road user operations considering the available geometric conditions.
- When water ballasted systems used as barriers have blunt ends exposed to traffic, they should be attenuated as per manufacturer recommendations or flared to a point outside the clear zone.

If used to channelize pedestrians, longitudinal channelizing devices or water ballasted systems must have a continuous detectable bottom for users of long cones and the top of the unit shall not be less than 32 inches in height.

HOLLOW OR WATER BALLASTED SYSTEMS USED AS LONGITUDINAL CHANNELIZING DEVICES OR BARRIERS

GENERAL NOTES

- Work Zone channelizing devices illustrated on this sheet may be installed in close proximity to traffic and are suitable for use on high or low speed roadways. The Engineer/Inspector shall ensure that spacing and placement is uniform and in accordance with the "Texas Manual on Uniform Traffic Control Devices" (TMUTCD).
- Channelizing devices shown on this sheet may have a driveable, fixed or portable base. The requirement for self-righting channelizing devices must be specified in the General Notes or other plan sheets.
- Channelizing devices on self-righting supports should be used in work zone areas where channelizing devices are frequently impacted by errant vehicles or vehicle related wind gusts making alignment of the channelizing devices difficult to maintain. Locations of these devices shall be detailed elsewhere in the plans. These devices shall conform to the TMUTCD and the "Compliant Work Zone Traffic Control Devices List" (CWZTCD).
- The Contractor shall maintain devices in a clean condition and replace damaged, nonreflective, faded, or broken devices and bases as required by the Engineer/Inspector. The Contractor shall be required to maintain proper device spacing and alignment.
- Portable bases shall be fabricated from virgin and/or recycled rubber. The portable bases shall weigh a minimum of 30 lbs.
- Pavement surfaces shall be prepared in a manner that ensures proper bonding between the adhesives, the fixed mount bases and the pavement surface. Adhesives shall be prepared and applied according to the manufacturer's recommendations.
- The installation and removal of channelizing devices shall not cause detrimental effects to the final pavement surfaces, including pavement surface discoloration or surface integrity. Driveable bases shall not be permitted on final pavement surfaces. The Engineer/Inspector shall approve all application and removal procedures of fixed bases.

Posted Speed x	Formula	Minimum Desirable Taper Lengths			Suggested Maximum Spacing of Channelizing Devices	
		10' Offset	11' Offset	12' Offset	On a Taper	On a Tangent
30	L = WS ² / 60	150'	165'	180'	30'	60'
35		205'	225'	245'	35'	70'
40		265'	295'	320'	40'	80'
45	L = WS	450'	495'	540'	45'	90'
50		500'	550'	600'	50'	100'
55		550'	605'	660'	55'	110'
60		600'	660'	720'	60'	120'
65		650'	715'	780'	65'	130'
70		700'	770'	840'	70'	140'
75		750'	825'	900'	75'	150'
80		800'	880'	960'	80'	160'

x x Taper lengths have been rounded off.
L=Length of Taper (FT.) W=Width of Offset (FT.)
S=Posted Speed (MPH)

SUGGESTED MAXIMUM SPACING OF CHANNELIZING DEVICES AND MINIMUM DESIRABLE TAPER LENGTHS

SHEET 9 OF 12



BARRICADE AND CONSTRUCTION CHANNELIZING DEVICES

BC(9)-14

FILE: bc-14.dgn	DN: TxDOT	CK: TxDOT	DW: TxDOT	CK: TxDOT
© TxDOT November 2002	CONT	SECT	JOB	HIGHWAY
REVISIONS				
9-07 8-14				
7-13	DIST	COUNTY		SHEET NO. 34

DATE: FILE:

DISCLAIMER: The use of this standard is governed by the "Texas Engineering Practice Act". No warranty of any kind is made by TxDOT for any purpose whatsoever. TxDOT assumes no responsibility for the conversion of this standard to other formats or for incorrect results or damages resulting from its use.

TYPE 3 BARRICADES

1. Refer to the Compliant Work Zone Traffic Control Devices List (CWZTCD) for details of the Type 3 Barricades and a list of all materials used in the construction of Type 3 Barricades.
2. Type 3 Barricades shall be used at each end of construction projects closed to all traffic.
3. Barricades extending across a roadway should have stripes that slope downward in the direction toward which traffic must turn in detouring. When both right and left turns are provided, the chevron striping may slope downward in both directions from the center of the barricade. Where no turns are provided at a closed road striping should slope downward in both directions toward the center of roadway.
4. Striping of rails, for the right side of the roadway, should slope downward to the left. For the left side of the roadway, striping should slope downward to the right.
5. Identification markings may be shown only on the back of the barricade rails. The maximum height of letters and/or company logos used for identification shall be 1".
6. Barricades shall not be placed parallel to traffic unless an adequate clear zone is provided.
7. Warning lights shall NOT be installed on barricades.
8. Where barricades require the use of weights to keep from turning over, the use of sandbags with dry, cohesionless sand is recommended. The sandbags will be tied shut to keep the sand from spilling and to maintain a constant weight. Sand bags shall not be stocked in a manner that covers any portion of a barricade rails reflective sheeting. Rock, concrete, iron, steel or other solid objects will NOT be permitted. Sandbags should weigh a minimum of 35 lbs and a maximum of 50 lbs. Sandbags shall be made of a durable material that tears upon vehicular impact. Rubber (such as tire inner tubes) shall not be used for sandbags. Sandbags shall only be placed along or upon the base supports of the device and shall not be suspended above ground level or hung with rope, wire, chains or other fasteners.
9. Sheeting for barricades shall be retroreflective Type A conforming to Departmental Material Specification DMS-8300 unless otherwise noted.

Barricades shall NOT be used as a sign support.

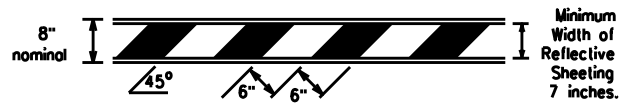

TYPICAL STRIPING DETAIL FOR BARRICADE RAIL

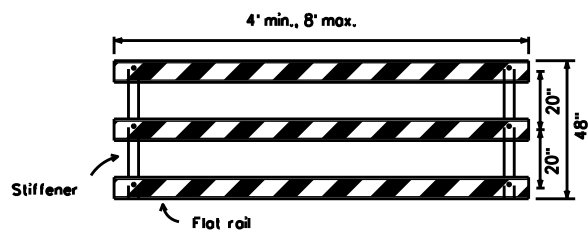

TYPICAL PANEL DETAIL FOR SKID OR POST TYPE BARRICADES

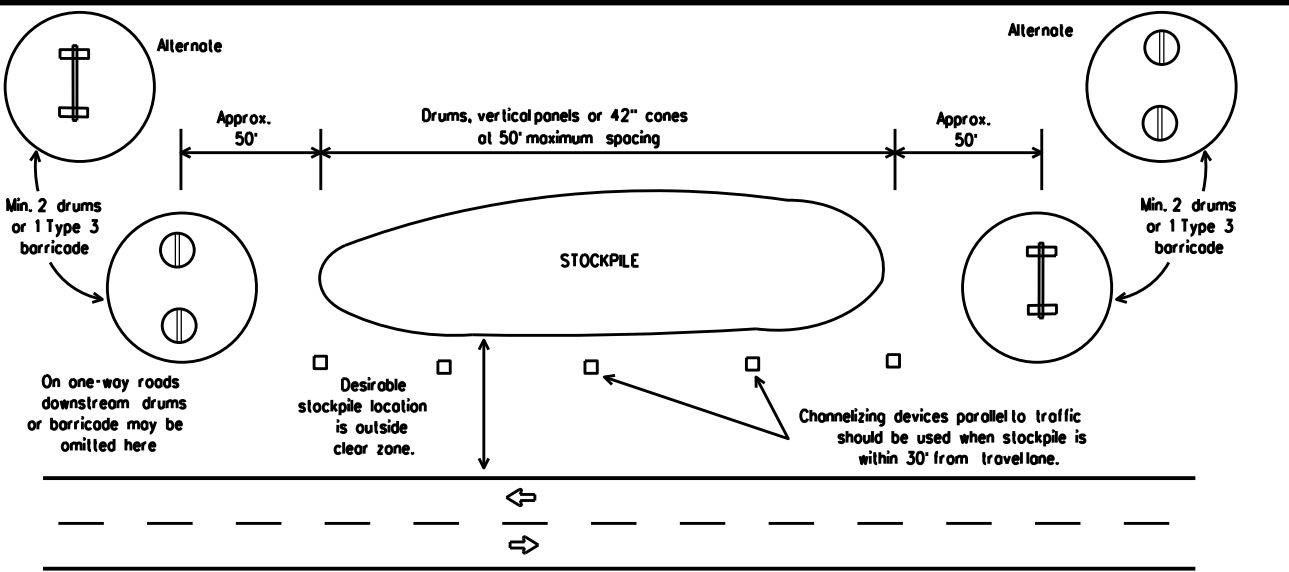

TRAFFIC CONTROL FOR MATERIAL STOCKPILES

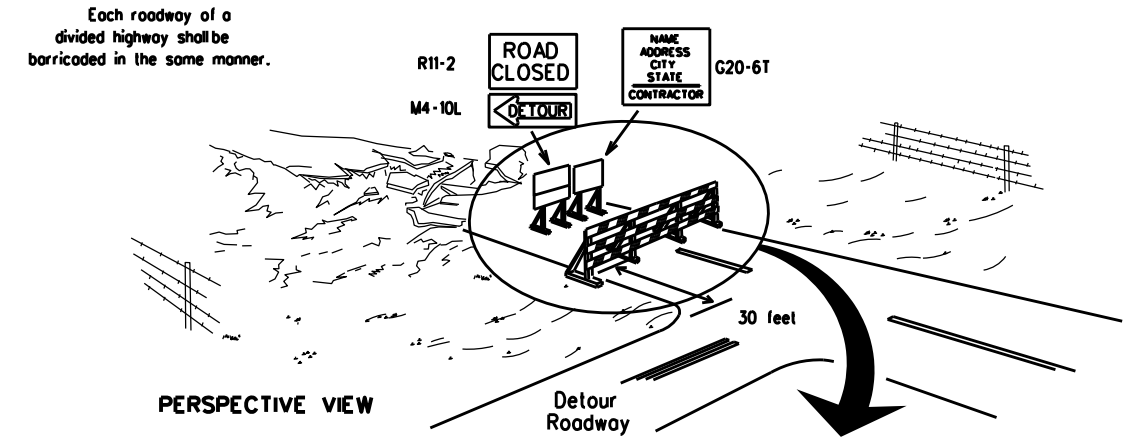

PERSPECTIVE VIEW

The three rails on Type 3 barricades shall be reflectorized orange and reflective white stripes on one side facing one-way traffic and both sides for two-way traffic. Barricade striping should slant downward in the direction of detour.

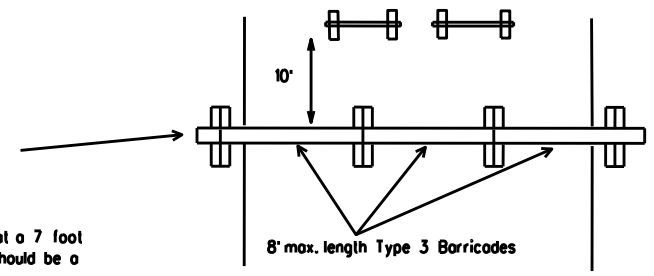

PLAN VIEW

1. Signs should be mounted on independent supports at a 7 foot mounting height in center of roadway. The signs should be a minimum of 10 feet behind Type 3 Barricades.
2. Advance signing shall be as specified elsewhere in the plans.

TYPE 3 BARRICADE (POST AND SKID) TYPICAL APPLICATION

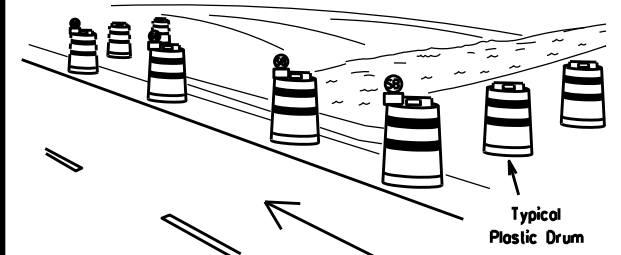

PERSPECTIVE VIEW

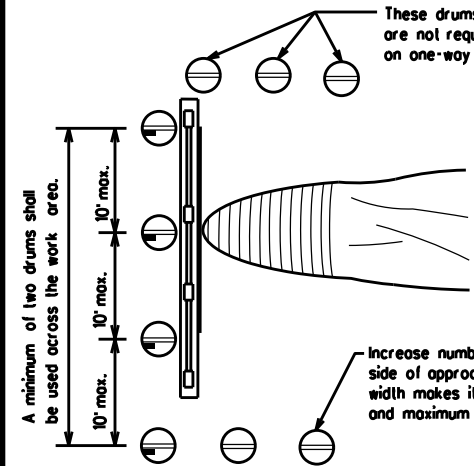

PLAN VIEW

1. Where positive redirection capability is provided, drums may be omitted.
2. Plastic construction fencing may be used with drums for safety as required in the plans.
3. Vertical Panels on flexible support may be substituted for drums when the shoulder width is less than 4 feet.
4. When the shoulder width is greater than 12 feet, steady-burn lights may be omitted if drums are used.
5. Drums must extend the length of the culvert widening.

LEGEND	
	Plastic drum
	Plastic drum with steady burn light or yellow warning reflector
	Steady burn warning light or yellow warning reflector

CULVERT WIDENING OR OTHER ISOLATED WORK WITHIN THE PROJECT LIMITS

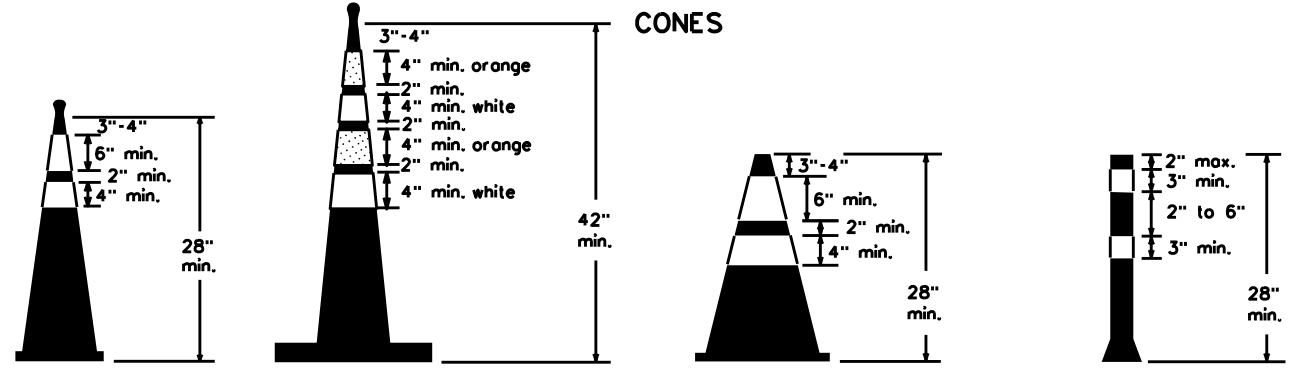

Two-Piece cones

One-Piece cones

Tubular Marker

28" Cones shall have a minimum weight of 9 1/2 lbs.
42" 2-piece cones shall have a minimum weight of 30 lbs. including base.

1. Traffic cones and tubular markers shall be predominantly orange, and meet the height and weight requirements shown above.
2. One-piece cones have the body and base of the cone molded in one consolidated unit. Two-piece cones have a cone shaped body and a separate rubber base, or ballast, that is added to keep the device upright and in place.
3. Two-piece cones may have a handle or loop extending up to 8" above the minimum height shown, in order to aid in retrieving the device.
4. Cones or tubular markers used at night shall have white or white and orange reflective bands as shown above. The reflective bands shall have a smooth, sealed outer surface and meet the requirements of Departmental Material Specification DMS-8300 Type A.
5. 28" cones and tubular markers are generally suitable for short duration and short-term stationary work as defined on BC(14). These should not be used for intermediate-term or long-term stationary work unless personnel is on-site to maintain them in their proper upright position.
6. 42" two-piece cones, vertical panels or drums are suitable for all work zone durations.
7. Cones or tubular markers used on each project should be of the same size and shape.

THIS DEVICE SHALL NOT BE USED ON PROJECTS LET AFTER MARCH 2014.

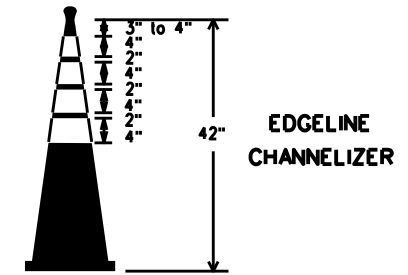

EDGE LINE CHANNELIZER

1. This device is intended only for use in place of a vertical panel to channelize traffic by indicating the edge of the travel lane. It is not intended to be used in transitions or tapers.
2. This device shall not be used to separate lanes of traffic (opposing or otherwise) or warn of objects.
3. This device is based on a 42 inch, two-piece cone with an alternate striping pattern: four 4 inch retroreflective bands, with an approximate 2 inch gap between bands. The color of the band should correspond to the color of the edgeline (yellow for left edgeline, white for right edgeline) for which the device is substituted or for which it supplements. The reflectorized bands shall be retroreflective Type A conforming to Departmental Material Specification DMS-8300, unless otherwise noted.
4. The base must weigh a minimum of 30 lbs.

SHEET 10 OF 12

Texas Department of Transportation Traffic Operations Division Standard

BARRICADE AND CONSTRUCTION CHANNELIZING DEVICES

BC(10)-14

FILE: bc-14.dgn	DN: TxDOT	CK: TxDOT	DW: TxDOT	CK: TxDOT
© TxDOT November 2002	CONT	SECT	JOB	HIGHWAY
REVISIONS				
9-07 8-14	DIST	COUNTY	SHEET NO.	
7-13			35	

DATE: FILE:

WORK ZONE PAVEMENT MARKINGS

GENERAL

- The Contractor shall be responsible for maintaining work zone and existing pavement markings, in accordance with the standard specifications and special provisions, on all roadways open to traffic within the CSJ limits unless otherwise stated in the plans.
- Color, patterns and dimensions shall be in conformance with the "Texas Manual on Uniform Traffic Control Devices" (TMUTCD).
- Additional supplemental pavement marking details may be found in the plans or specifications.
- Pavement markings shall be installed in accordance with the TMUTCD and as shown on the plans.
- When short term markings are required on the plans, short term markings shall conform with the TMUTCD, the plans and details as shown on the Standard Plan Sheet WZ(STPM).
- When standard pavement markings are not in place and the roadway is opened to traffic, DO NOT PASS signs shall be erected to mark the beginning of the sections where passing is prohibited and PASS WITH CARE signs at the beginning of sections where passing is permitted.
- All work zone pavement markings shall be installed in accordance with Item 662, "Work Zone Pavement Markings."

RAISED PAVEMENT MARKERS

- Raised pavement markers are to be placed according to the patterns on BC(12).
- All raised pavement markers used for work zone markings shall meet the requirements of Item 672, "RAISED PAVEMENT MARKERS" and Departmental Material Specification DMS-4200 or DMS-4300.

PREFABRICATED PAVEMENT MARKINGS

- Removable prefabricated pavement markings shall meet the requirements of DMS-8241.
- Non-removable prefabricated pavement markings (foil back) shall meet the requirements of DMS-8240.

MAINTAINING WORK ZONE PAVEMENT MARKINGS

- The Contractor will be responsible for maintaining work zone pavement markings within the work limits.
- Work zone pavement markings shall be inspected in accordance with the frequency and reporting requirements of work zone traffic control device inspections as required by Form 599.
- The markings should provide a visible reference for a minimum distance of 300 feet during normal daylight hours and 160 feet when illuminated by automobile low-beam headlights at night, unless sight distance is restricted by roadway geometrics.
- Markings failing to meet this criteria within the first 30 days after placement shall be replaced at the expense of the Contractor as per Specification Item 662.

REMOVAL OF PAVEMENT MARKINGS

- Pavement markings that are no longer applicable, could create confusion or direct a motorist toward or into the closed portion of the roadway shall be removed or obliterated before the roadway is opened to traffic.
- The above shall not apply to detours in place for less than three days, where flaggers and/or sufficient channelizing devices are used in lieu of markings to outline the detour route.
- Pavement markings shall be removed to the fullest extent possible, so as not to leave a discernable marking. This shall be by any method approved by TxDOT Specification Item 677 for "Eliminating Existing Pavement Markings and Markers".
- The removal of pavement markings may require resurfacing or seal coating portions of the roadway as described in Item 677.
- Subject to the approval of the Engineer, any method that proves to be successful on a particular type pavement may be used.
- Blast cleaning may be used but will not be required unless specifically shown in the plans.
- Over-painting of the markings SHALL NOT BE permitted.
- Removal of raised pavement markers shall be as directed by the Engineer.
- Removal of existing pavement markings and markers will be paid for directly in accordance with Item 677, "ELIMINATING EXISTING PAVEMENT MARKINGS AND MARKERS," unless otherwise stated in the plans.
- Block-out marking tape may be used to cover conflicting existing markings for periods less than two weeks when approved by the Engineer.

Temporary Flexible-Reflective Roadway Marker Tabs

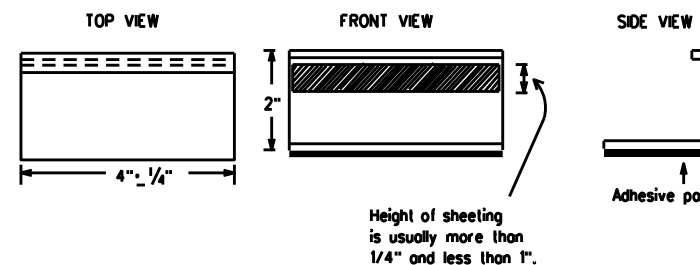

**STAPLES OR NAILS SHALL NOT BE USED TO SECURE
TEMPORARY FLEXIBLE-REFLECTIVE ROADWAY MARKER
TABS TO THE PAVEMENT SURFACE**

- Temporary flexible-reflective roadway marker tabs used as guidemarks shall meet the requirements of DMS-8242.
- Tabs detailed on this sheet are to be inspected and accepted by the Engineer or designated representative. Sampling and testing is not normally required, however at the option of the Engineer, either "A" or "B" below may be imposed to assure quality before placement on the roadway.
 - Select five (5) or more tabs at random from each lot or shipment and submit to the Construction Division, Materials and Pavement Section to determine specification compliance.
 - Select five (5) tabs and perform the following test. Affix five (5) tabs at 24 inch intervals on an asphaltic pavement in a straight line. Using a medium size passenger vehicle or pickup, run over the markers with the front and rear tires at a speed of 35 to 40 miles per hour, four (4) times in each direction. No more than one (1) out of the five (5) reflective surfaces shall be lost or displaced as a result of this test.
- Small design variances may be noted between tab manufacturers.
- See Standard Sheet WZ(STPM) for tab placement on new pavements. See Standard Sheet TCP(7-1) for tab placement on seal coat work.

RAISED PAVEMENT MARKERS USED AS GUIDEMARKS

- Raised pavement markers used as guidemarks shall be from the approved product list, and meet the requirements of DMS-4200.
- All temporary construction raised pavement markers provided on a project shall be of the same manufacturer.
- Adhesive for guidemarks shall be bituminous material hot applied or butyl rubber pad for all surfaces, or thermoplastic for concrete surfaces.

Guidemarks shall be designated as:
 YELLOW - (two amber reflective surfaces with yellow body).
 WHITE - (one silver reflective surface with white body).

DEPARTMENTAL MATERIAL SPECIFICATIONS	
PAVEMENT MARKERS (REFLECTORIZED)	DMS-4200
TRAFFIC BUTTONS	DMS-4300
EPOXY AND ADHESIVES	DMS-6100
BITUMINOUS ADHESIVE FOR PAVEMENT MARKERS	DMS-6130
PERMANENT PREFABRICATED PAVEMENT MARKINGS	DMS-8240
TEMPORARY REMOVABLE, PREFABRICATED PAVEMENT MARKINGS	DMS-8241
TEMPORARY FLEXIBLE, REFLECTIVE ROADWAY MARKER TABS	DMS-8242

A list of prequalified reflective raised pavement markers, non-reflective traffic buttons, roadway marker tabs and other pavement markings can be found at the Material Producer List web address shown on BC(1).

SHEET 11 OF 12

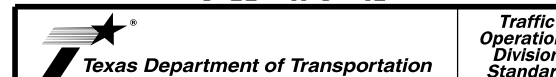

BARRICADE AND CONSTRUCTION PAVEMENT MARKINGS

BC(11)-14

FILE: bc-14.dgn	DN: TxDOT	CK: TxDOT	DW: TxDOT	CK: TxDOT
© TxDOT February 1998	CONT	SECT	JOB	HIGHWAY
REVISIONS				
2-98 9-07				
1-02 7-13				
11-02 8-14				
	DIST	COUNTY	SHEET NO.	
			36	

DISCLAIMER: The use of this standard is governed by the "Texas Engineering Practice Act." No warranty of any kind is made by TxDOT for any purpose whatsoever. TxDOT assumes no responsibility for the conversion of this standard to other formats or for incorrect results or damages resulting from its use.

DATE:
FILE:

PAVEMENT MARKING PATTERNS

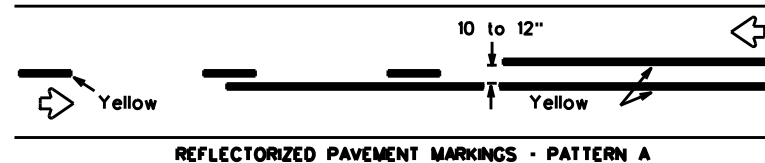

REFLECTORIZED PAVEMENT MARKINGS - PATTERN A

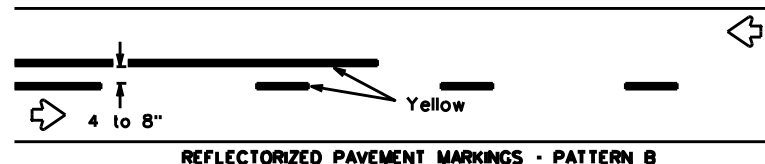

REFLECTORIZED PAVEMENT MARKINGS - PATTERN B

Pattern A is the TxDOT Standard, however Pattern B may be used if approved by the Engineer. Prefabricated markings may be substituted for reflectORIZED pavement markings.

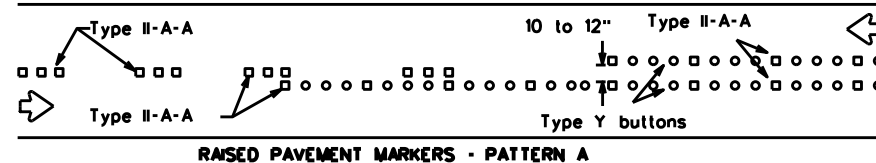

RAISED PAVEMENT MARKERS - PATTERN A

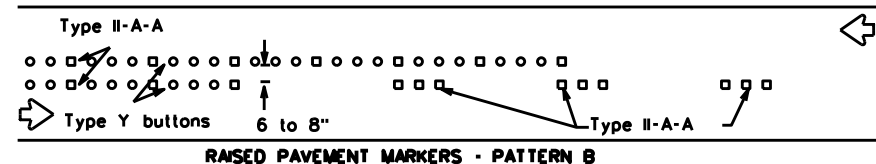

RAISED PAVEMENT MARKERS - PATTERN B

CENTER LINE & NO-PASSING ZONE BARRIER LINES FOR TWO-LANE, TWO-WAY HIGHWAYS

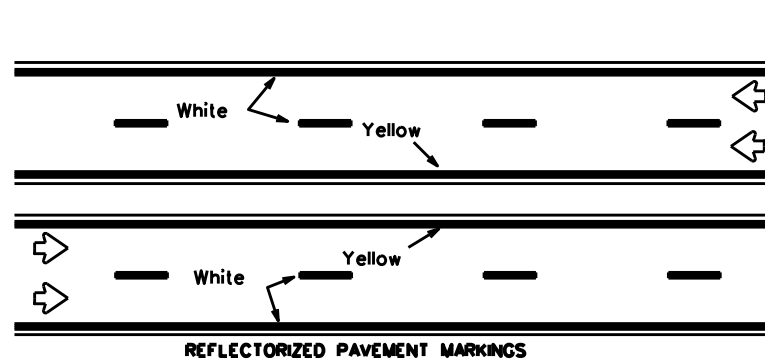

REFLECTORIZED PAVEMENT MARKINGS

Prefabricated markings may be substituted for reflectORIZED pavement markings.

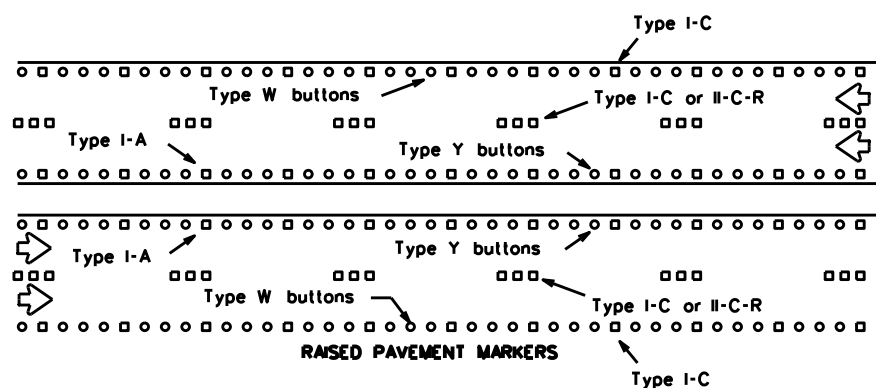

RAISED PAVEMENT MARKERS

EDGE & LANE LINES FOR DIVIDED HIGHWAY

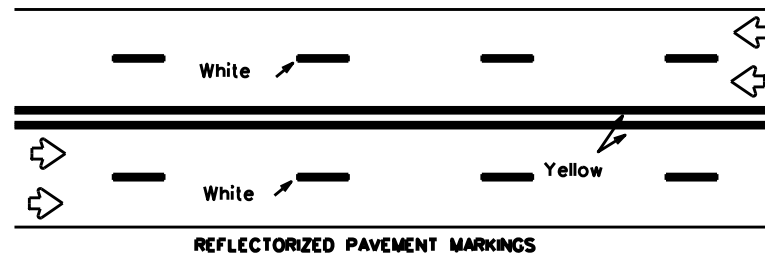

REFLECTORIZED PAVEMENT MARKINGS

Prefabricated markings may be substituted for reflectORIZED pavement markings.

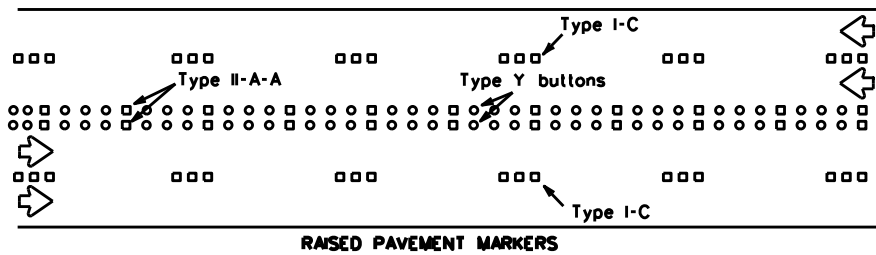

RAISED PAVEMENT MARKERS

LANE & CENTER LINES FOR MULTILANE UNDIVIDED HIGHWAYS

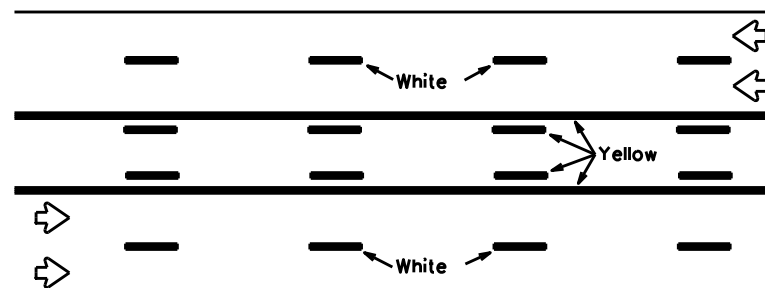

REFLECTORIZED PAVEMENT MARKINGS

Prefabricated markings may be substituted for reflectORIZED pavement markings.

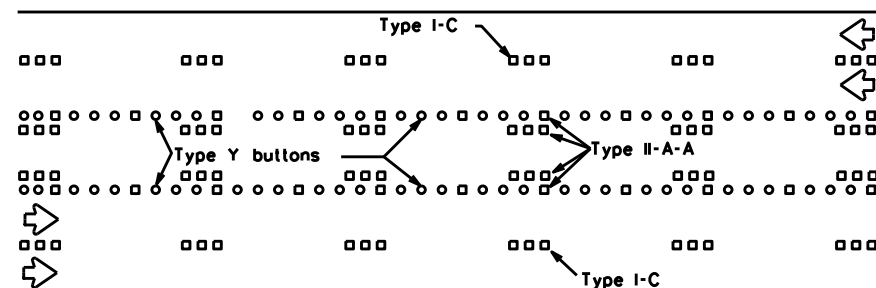

RAISED PAVEMENT MARKERS

TWO-WAY LEFT TURN LANE

STANDARD WORK ZONE PAVEMENT MARKINGS DETAILS

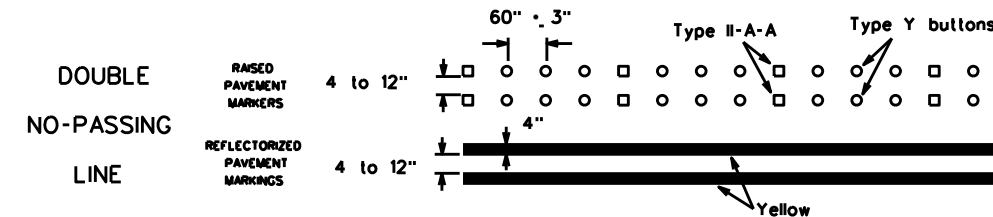

SOLID LINES

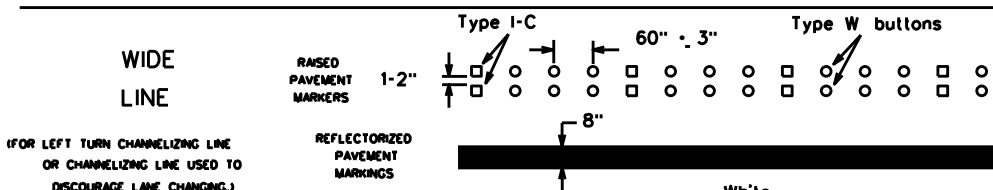
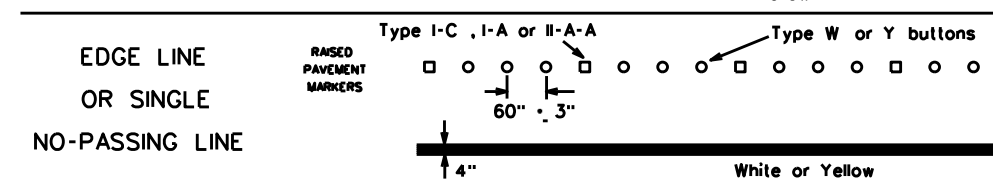

(FOR LEFT TURN CHANNELIZING LINE OR CHANNELIZING LINE USED TO DISCOURAGE LANE CHANGING.)

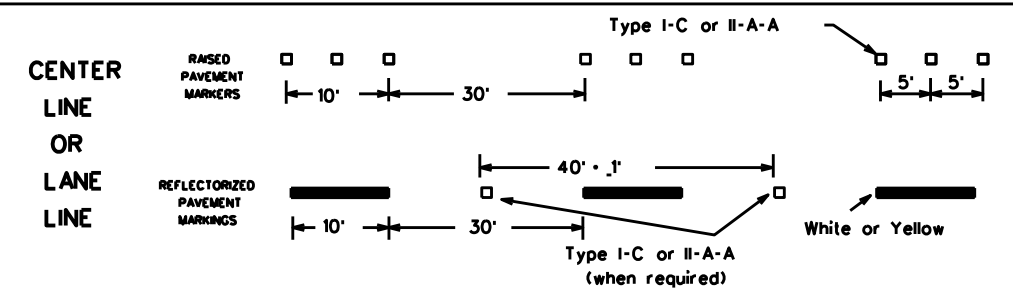

BROKEN LINES

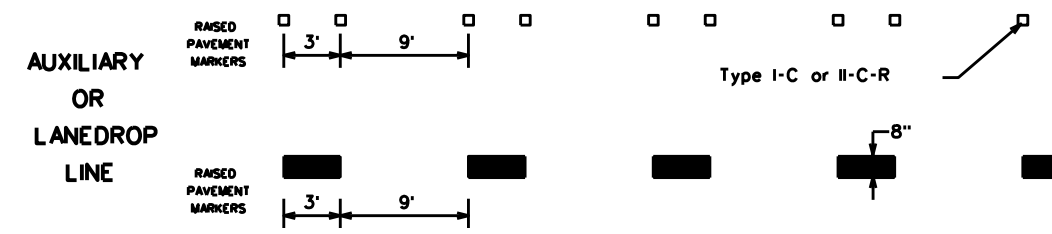

REMOVABLE MARKINGS WITH RAISED PAVEMENT MARKERS

If raised pavement markers are used to supplement REMOVABLE markings, the markers shall be applied to the top of the tape at the approximate mid length of tape used for broken lines or at 20 foot spacing for solid lines. This allows an easier removal of raised pavement markers and tape.

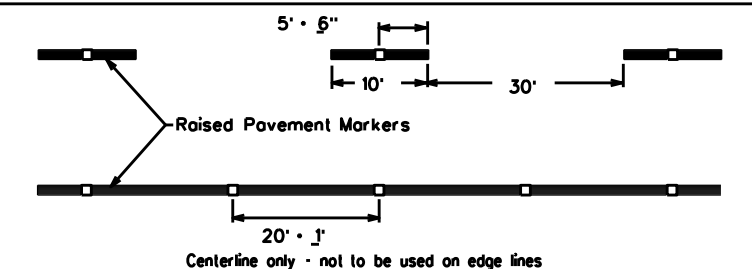

SHEET 12 OF 12



BARRICADE AND CONSTRUCTION PAVEMENT MARKING PATTERNS

BC(12)-14

Raised pavement markers used as standard pavement markings shall be from the approved products list and meet the requirements of Item 672 "RAISED PAVEMENT MARKERS."

FILE: bc-14.dgn	DN: TxDOT	CK: TxDOT	DW: TxDOT	CK: TxDOT
© TxDOT February 1998	CONT	SECT	JOB	HIGHWAY
REVISIONS				
1-97 9-07				
2-98 7-13				
11-02 8-14				
	DIST	COUNTY	SHEET NO.	
			37	

DISCLAIMER: The use of this standard is governed by the "Texas Engineering Practice Act". No warranty of any kind is made by TxDOT for any purpose whatsoever. TxDOT assumes no responsibility for the conversion of this standard to other formats or for incorrect results or damages resulting from its use.

DATE: FILE:

DISCLAIMER: The use of this standard is governed by the "Texas Engineering Practice Act". No warranty of any kind is made by TxDOT for any purpose whatsoever. TxDOT assumes no responsibility for the conversion of this standard to other formats or for incorrect results or damages resulting from its use.

DATE: FILE:

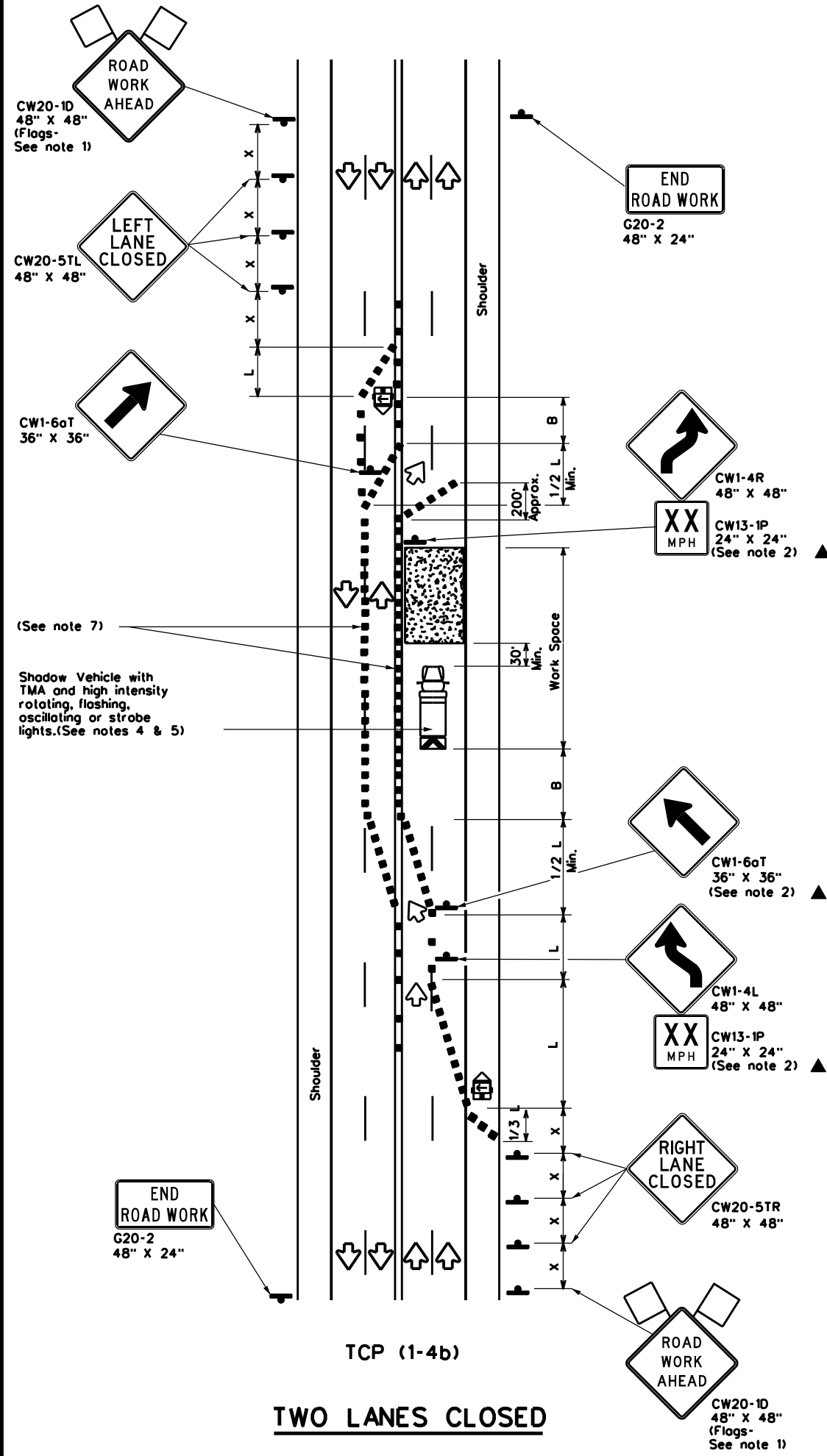
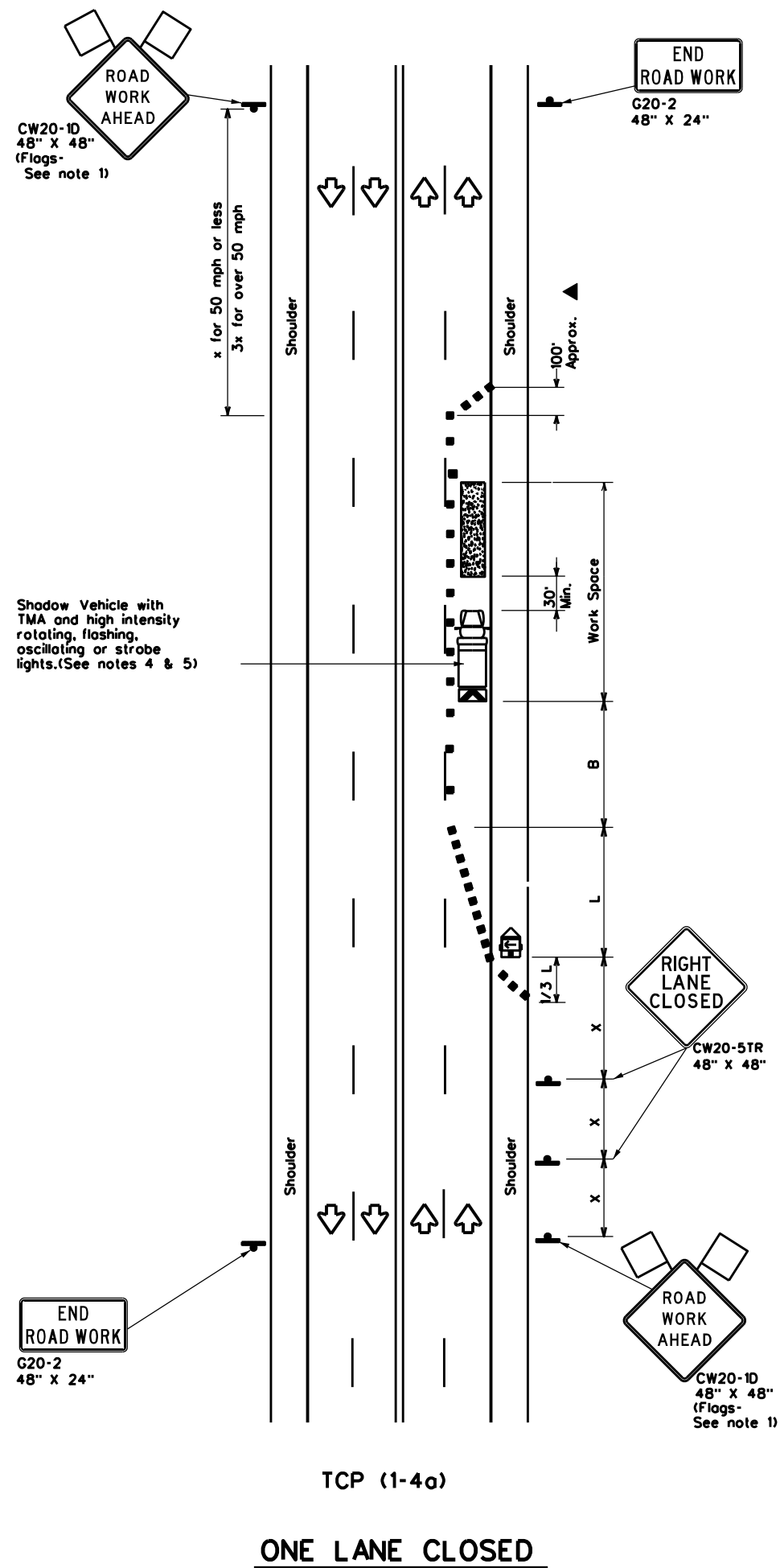

LEGEND			
	Type 3 Barricade		Channelizing Devices
	Heavy Work Vehicle		Truck Mounted Attenuator (TMA)
	Trailer Mounted Flashing Arrow Board		Portable Changeable Message Sign (PCMS)
	Sign		Traffic Flow
	Flag		Flagger

Posted Speed x	Formula	Minimum Desirable Taper Lengths x x			Suggested Maximum Spacing of Channelizing Devices		Minimum Sign Spacing "x" Distance	Suggested Longitudinal Buffer Space "B"
		10' Offset	11' Offset	12' Offset	On a Taper	On a Tangent		
30	L = WS ² / 60	150'	165'	180'	30'	60'	120'	90'
35		205'	225'	245'	35'	70'	160'	120'
40	L = WS	265'	295'	320'	40'	80'	240'	155'
45		450'	495'	540'	45'	90'	320'	195'
50	L = WS	500'	550'	600'	50'	100'	400'	240'
55		550'	605'	660'	55'	110'	500'	295'
60	L = WS	600'	660'	720'	60'	120'	600'	350'
65		650'	715'	780'	65'	130'	700'	410'
70	L = WS	700'	770'	840'	70'	140'	800'	475'
75		750'	825'	900'	75'	150'	900'	540'

x Conventional Roads Only
 xx Taper lengths have been rounded off.
 L-Length of Taper(FT) W-Width of Offset(FT) S-Posted Speed(MPH)

TYPICAL USAGE				
MOBILE	SHORT DURATION	SHORT TERM STATIONARY	INTERMEDIATE TERM STATIONARY	LONG TERM STATIONARY
	✓	✓		

- GENERAL NOTES**
- Flags attached to signs where shown are REQUIRED.
 - All traffic control devices illustrated are REQUIRED, except those denoted with the triangle symbol may be omitted when stated elsewhere in the plans, or for routine maintenance work, when approved by the Engineer.
 - The CW20-1D "ROAD WORK AHEAD" sign may be repeated if the visibility of the work zone is less than 1500 feet.
 - A Shadow Vehicle with a TMA should be used anytime it can be positioned 30 to 100 feet in advance of the area of crew exposure without adversely affecting the performance or quality of the work. If workers are no longer present but road or work conditions require the traffic control to remain in place, Type 3 Barricades or other channelizing devices may be substituted for the Shadow Vehicle and TMA.
 - Additional Shadow Vehicles with TMAs may be positioned off the paved surface, next to those shown in order to protect wider work spaces.
- TCP (1-4g)**
- If this TCP is used for a left lane closure, CW20-5TL "LEFT LANE CLOSED" signs shall be used and channelizing devices shall be placed on the centerline where needed to protect the work space from opposing traffic with the arrow panel placed in the closed lane near the end of the merging taper.
- TCP (1-4b)**
- Where traffic is directed over a yellow centerline, channelizing devices which separate two-way traffic should be spaced on tapers at 20' or 15' if posted speeds are 35 mph or slower, and for tangent sections, at 1/2S where S is the speed in mph. This tighter device spacing is intended for the areas of conflicting markings, not the entire work zone.

Texas Department of Transportation
 Traffic Operations Division Standard

TRAFFIC CONTROL PLAN LANE CLOSURES ON MULTILANE CONVENTIONAL ROADS

TCP(1-4)-18

FILE: tcp1-4-18.dgn	DN:	CK:	DW:	CK:
© TxDOT December 1985	CONT	SECT	JOB	HIGHWAY
REVISIONS				
2-94 4-98				
8-95 2-12				
1-97 2-18				
DIST	COUNTY			SHEET NO.
				35

154

DISCLAIMER: The use of this standard is governed by the "Texas Engineering Practice Act". No warranty of any kind is made by TxDOT for any purpose whatsoever. TxDOT assumes no responsibility for the conversion of this standard to other formats or for incorrect results or damages resulting from its use.

DATE:
FILE:

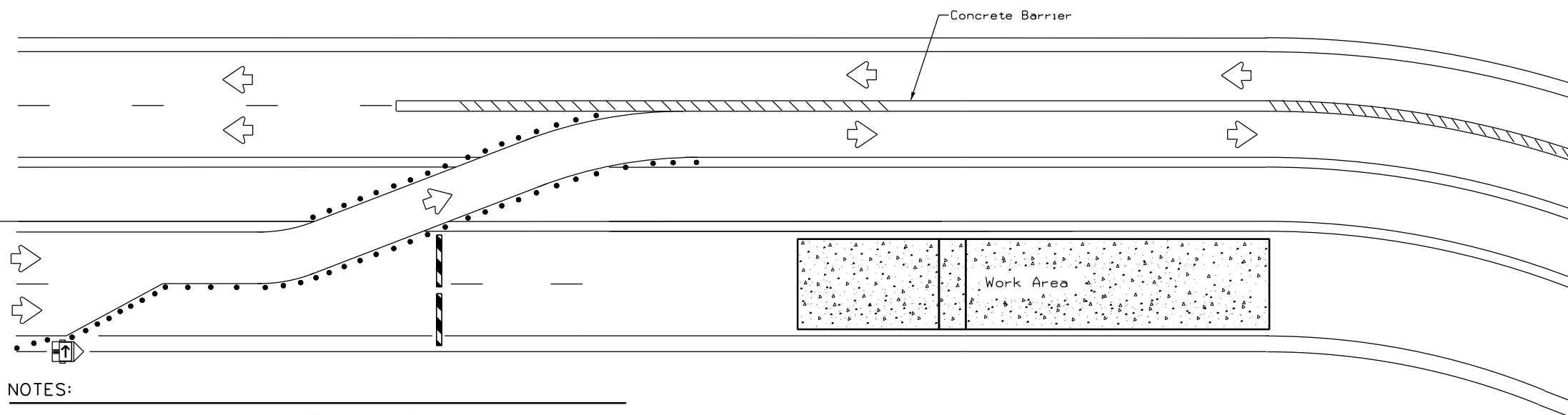

NOTES:

1. Length of Safety Glare screen will be specified elsewhere in the plans.
2. The cumulative nominal length of the modular safety glare screen units shall equal the length of the individual sections of temporary concrete traffic barrier on which they are installed so the joint between barrier sections will not be spanned by any one safety glare screen unit.
3. Screen Panel/blades will be designed such that reflective sheeting conforming with Departmental Material Specification DMS-8300, Sign Face Materials, Type B or C Yellow, minimum size of 2 inches by 12 inches can be attached to the edge of the panel/blade. The sheeting shall be attached to one glare screen panel/blade per section of concrete barrier not to exceed a spacing of 30 feet. Barrier reflectors are not necessary when panel/blades are installed with reflective sheeting as described.
4. Payment for these devices will be under statewide Special Specification "Modular Glare Screens for Headlight Barrier."
5. This detail is only intended to show types of locations where Glare Screens would be appropriate. Required signing and other devices shall be as shown elsewhere in the plans.

BARRIER DELINEATION WITH MODULAR GLARE SCREENS

LEGEND	
	Type 3 Barricade
	Channelizing Devices
	Trailer Mounted Flashing Arrow Board
	Sign
	Safety glare screen

DEPARTMENTAL MATERIAL SPECIFICATIONS	
SIGN FACE MATERIALS	DMS-8300
DELINEATORS AND OBJECT MARKERS	DMS-8600
MODULAR GLARE SCREENS FOR HEADLIGHT BARRIER	DMS-8610

Only pre-qualified products shall be used. A copy of the Compliant Work Zone Traffic Control Devices List" (CWZTCD) describes pre-qualified products and their sources and may be found at the following web address:

<http://www.txdot.gov/business/resources/producer-list.html>

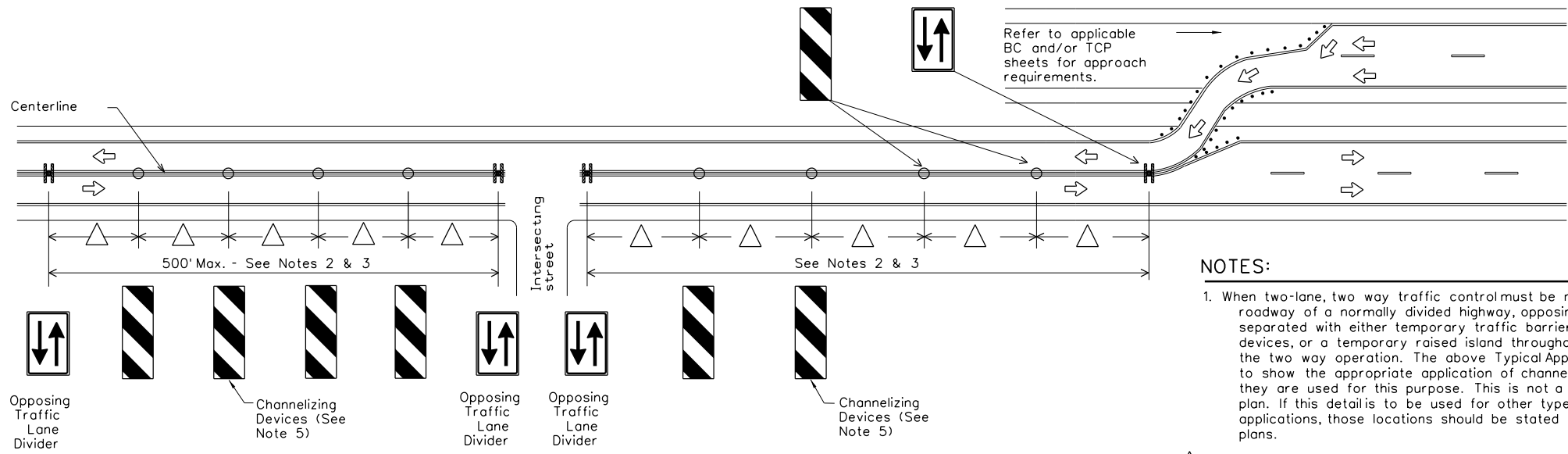

NOTES:

1. When two-lane, two way traffic control must be maintained on one roadway of a normally divided highway, opposing traffic shall be separated with either temporary traffic barriers, channelizing devices, or a temporary raised island throughout the length of the two way operation. The above Typical Application is intended to show the appropriate application of channelizing devices when they are used for this purpose. This is not a traffic control plan. If this detail is to be used for other types of roads or applications, those locations should be stated elsewhere in the plans.
2. Space devices according to the Tangent Spacing shown on the Device Spacing table on BC(9) but not exceeding 100'.
3. Every fifth device should be an OTLD except when spaced closer to accommodate an intersection. An OTLD should be the first device on each side of intersecting streets or roads.
4. Locations where surface mount bases with adhesives or self-righting devices will be required in order to maintain them in their proper position should be noted elsewhere in the plans.
5. Channelizing devices are to be vertical panels, 42" cones or tubular markers that are at least 36" tall. Tubular markers used to separate traffic should have a rubber base weighing at least 30 pounds. Tubular markers that are 42" tall or more shall have four bands of reflective material as detailed for 42" cones on BC(10). Tubular markers less than 42" but at least 36" tall shall have three bands of 3" wide white reflective material spaced 2" apart. Reflective material shall meet DMS-8300, Type A.

VERTICAL PANELS & OPPOSING TRAFFIC LANE DIVIDERS (OTLD) SEPARATING TWO-WAY TRAFFIC ON NORMALLY DIVIDED HIGHWAYS

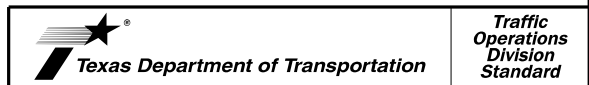

TRAFFIC CONTROL PLAN TYPICAL DETAILS

WZ(TD)-17

FILE: wzt1d-17.dgn	DN: TxDOT	CK: TxDOT	DW: TxDOT	CK: TxDOT
© TxDOT February 1998	CONT	SECT	JOB	HIGHWAY
4-98 3-03 7-13	REVISIONS		DIST	COUNTY
2-17				SHEET NO. 38