

**GALVESTON COUNTY
PURCHASING DEPARTMENT**



REQUEST FOR PROPOSAL

RFP #B231010

SEPTIC TANK SERVICES – RUNGE PARK

PROPOSAL DUE DATE: 2/24/2023

2:00 P.M.

***Rufus Crowder, CPPO, CPPB
Purchasing Agent
Galveston County
722 Moody (21st Street)
Fifth (5th) Floor
Galveston, Texas 77550
(409) 770-5372***



REQUEST FOR PROPOSAL SEPTIC TANK SERVICES – RUNGE PARK FOR GALVESTON COUNTY

Purpose:

Galveston County is seeking proposals for an outside contractor to repair the onsite septic facility (OSSF) and replace the drip field at Runge Park located at 4605 Peck Avenue, Santa Fe, Texas

This septic tank system services the bathrooms located in the concession building at the Runge Park Ballfield Complex.

Norex Engineering has designed plans for the modified aerobic septic drip disposal system. Contractor has the option to provide an alternate design as long as it adheres to all city, county, and state requirements as required by TCEQ. New engineered designed plans would be the responsibility of the contractor if they don't follow the provided design.

Respondents shall provide a response that will address the required services shown in the Scope of Work.

Submittal Instructions:

Sealed proposals in **sets of five (5), one (1) single-sided unbound original and four (4) single-sided copies**, will be received in the office of the Galveston County Purchasing Agent until **2:00 P.M. CST, on Friday, February 24, 2023**, and opened immediately in that office in the presence of Galveston County Auditor and the Purchasing Agent. Sealed proposals are to be delivered to Rufus G. Crowder, CPPO CPPB, Galveston County Purchasing Agent at the Galveston County Courthouse, 722 Moody, (21st Street), Floor 5, Purchasing, Galveston, Texas 77550, (409) 770-5372.

All proposals must be marked on the outside of the envelope:

RFP #B231010

SEPTIC TANK SERVICES – RUNGE PARK

Proposer's name and return address should be prominently displayed on the proposal package for identification purposes.

The timestamp clock located in the Purchasing Agent's office shall serve as the official timekeeping piece for this solicitation process. Any proposals received after 2:00 P.M. on the specified date will be returned unopened.

Specifications:

Specifications can be obtained on application at the office of the Galveston County Purchasing Agent, located in the Galveston County Courthouse, 722 Moody, (21st Street), Floor 5, Purchasing, Galveston, Texas, 77550, or by visiting the Galveston County website @ <http://www.galvestoncountytexas.gov/county-offices/purchasing>

Virtual Bid Opening:

Interested parties can attend the Friday, February 24, 2023, 2:00 p.m. virtual bid opening at the link mentioned below:

<https://galvestoncountytexas.webex.com/galvestoncountytexas/j.php?MTID=ma9da7ac4edeefeef9719ef44a8576cc3>

DAVIS-BACON WAGE RATES

Attention is called to the fact that not less than, the federally determined prevailing (Davis-Bacon and Related Acts) wage rate, as issued by the Office of Rural Community Affairs and contained in the contract documents, must be paid on this project. In addition, the successful Responder must ensure that employees and applicants for employment are not discriminated against because of race, color, religion, sex age or national origin.

Bonding Requirements:

Performance and Payment Bonds are requirements of this solicitation.

The Galveston County Commissioners' Court reserves the right to waive any informality and reject any and all proposals, and to accept the proposal which, in its opinion, is most advantageous to Galveston County with total respect to the governing laws.

Rufus G. Crowder, CPPO CPPB
Purchasing Agent
Galveston County

GENERAL PROVISIONS

**REQUEST FOR PROPOSAL
SEPTIC TANK SERVICES – RUNGE PARK
GALVESTON COUNTY, TEXAS**

Table of Contents

1.	RFP PACKAGE	4
2.	PROPOSER’S RESPONSIBILITY.....	4
3.	TIME FOR RECEIVING PROPOSALS	5
4.	COMPETITIVENESS, INTEGRITY, INQUIRIES AND QUESTIONS	5
5.	PROPOSAL OPENING	6
6.	WITHDRAWAL OF PROPOSAL / FIRM PROPOSAL RULE.....	6
7.	COMMISSIONERS’ COURT.....	6
8.	REJECTION OF PROPOSALS / DISQUALIFICATION	7
9.	RESTRICTIVE OR AMBIGUOUS SPECIFICATIONS	7
10.	SUBSTITUTES / DESCRIPTION OF MATERIALS AND EQUIPMENT	7
11.	EXCEPTIONS TO PROPOSAL CONDITIONS	8
12.	AWARDED PRICES	8
13.	PROCUREMENT CARD (P-CARD) PROGRAM	8
14.	PASS THROUGH COST ADJUSTMENTS.....	9
15.	MODIFICATION OF PROPOSALS.....	9
16.	PRE-PROPOSAL CONFERENCE	9
17.	SIGNATURE OF PROPOSALS.....	10
18.	AWARD OF PROPOSALS – EVALUATION CRITERIA AND FACTORS.....	10
19.	DISPUTE AFTER AWARD / PROTEST.....	11
20.	PUBLIC INFORMATION ACT (F/K/A OPEN RECORDS ACT)	12
21.	PROPOSER’S E-MAIL ADDRESSES – CONSENT TO DISCLOSURE.....	12
22.	RESULTANT CONTRACT	12
23.	CONTRACT TERM.....	14
25.	TERMINATION FOR DEFAULT	14
26.	TERMINATION FOR CONVENIENCE.....	15
27.	FORCE MAJEURE	15
28.	ESTIMATED QUANTITIES.....	15
29.	CONTRACTOR INVESTIGATION.....	15
30.	NO COMMITMENT BY COUNTY OF GALVESTON.....	15

GENERAL PROVISIONS

**REQUEST FOR PROPOSAL
SEPTIC TANK SERVICES – RUNGE PARK
GALVESTON COUNTY, TEXAS**

31.	PROPOSAL COSTS BORNE BY PROPOSER.....	16
32.	BEST AND FINAL OFFERS (BAFO).....	16
33.	SINGLE PROPOSAL RESPONSE	16
34.	CHANGES IN SPECIFICATIONS	16
35.	PROPOSAL IDEAS AND CONCEPTS	16
36.	PROPOSAL DISCLOSURES.....	17
37.	INDEMNIFICATION	17
38.	REQUIREMENT OF AND PROOF OF INSURANCE.....	17
39.	PROPOSAL GUARANTEE	19
40.	PERFORMANCE AND PAYMENT BONDS (IF REQUIRED)	19
41.	PATENT AND COPYRIGHT PROTECTION	20
42.	CONFLICT OF INTEREST DISCLOSURE REPORTING (FORM CIQ)	20
43.	DISCLOSURE OF INTERESTED PARTIES / FORM 1295.....	22
44.	CERTIFICATION REGARDING DEBARMENT, SUSPENSION, PROPOSED DEBARMENT, AND OTHER RESPONSIBILITY MATTERS & REQUIREMENT TO REGISTER IN SAM.....	22
45.	TRANSACTIONS WITH TERRORIST ORGANIZATIONS PROHIBITED	23
46.	VERIFICATION NOT TO BOYCOTT ISRAEL	24
47.	SOVEREIGN IMMUNITY.....	24
48.	CONTROLLING LAW AND VENUE	25
49.	MERGERS, ACQUISITIONS	25
50.	DELAYS.....	25
51.	ACCURACY OF DATA	25
52.	SUBCONTRACTING/ASSIGNMENT	25
53.	INDEPENDENT CONTRACTOR	26
54.	MONITORING PERFORMANCE	26
55.	SUBJECT TO APPROPRIATION OF FUNDS.....	26
56.	CONTRACTS SUBJECT TO GRANT FUNDING.....	26
57.	PROCUREMENT ETHICS.....	26
58.	NON-COLLUSION AFFIDAVIT.....	28
59.	CERTIFICATION REGARDING LOBBYING – COMPLIANT WITH APPENDIX A TO 24 C.F.R. PART 871.....	29
60.	NON-DISCRIMINATION	29

GENERAL PROVISIONS

**REQUEST FOR PROPOSAL
SEPTIC TANK SERVICES – RUNGE PARK
GALVESTON COUNTY, TEXAS**

61.	RECORD RETENTION AND RIGHT TO AUDIT.....	30
62.	TITLE VI ASSURANCES/TXDOT.....	31
63.	ASSURANCES FOR CONSTRUCTION PROGRAMS - TEXAS GENERAL LAND OFFICE (GLO) 32	
64.	GENERAL AFFIRMATIONS – TEXAS GENERAL LAND OFFICE (GLO).....	35
65.	SECTION 231.006, FAMILY CODE/DELINQUENT CHILD SUPPORT	42
66.	ANTITRUST	42
67.	LABOR STANDARDS.....	42
68.	PROCUREMENT STANDARDS -.....	42
69.	PROCUREMENT LAWS	54
71.	REQUIRED CONTRACT PROVISIONS.....	61
	DEBARMENT / SUSPENSION AND VOLUNTARY EXCLUSION (2 CFR APPENDIX II TO PART 200 (I))	65
72.	NON-EXCLUSIVE LIST OF APPLICABLE LAWS, RULES, AND REGULATIONS – TEXAS GENERAL LAND OFFICE (GLO)	79
73.	SPECIAL CONDITIONS – TEXAS GENERAL LAND OFFICE (GLO)	83
74.	ENERGY EFFICIENCY (42 U.S.C. 6201 AND 2 CFR 200 APPENDIX II (H))	87
75.	LEAD AND ASBESTOS	88
76.	USE OF DHS SEAL, LOGO, AND FLAGS PROHIBITED WITHOUT PRIOR APPROVAL	88
77.	FEDERAL GOVERNMENT NOT A PARTY	88
78.	PROGRAM FRAUD AND FALSE OR FRAUDULENT STATEMENTS OR RELATED ACTS	88
79.	ACKNOWLEDGMENT OF GOVERNMENT RECORD.....	88
80.	COMPLIANCE WITH GALVESTON COUNTY PURCHASING POLICIES AND PROCEDURES 88	
81.	ENTIRETY OF AGREEMENT AND MODIFICATION.....	88
82.	NOTICE	89

GENERAL PROVISIONS

REQUEST FOR PROPOSAL SEPTIC TANK SERVICES – RUNGE PARK GALVESTON COUNTY, TEXAS

The Special Provisions and the General Provisions of this Request for Proposal and the Exhibits attached hereto are made a part of this agreement between the Parties. In the event of a conflict between the General Provisions and the Special Provisions, the terms of the Special Provisions shall control.

1. RFP PACKAGE

*The Request for Proposal, General and Special provisions, drawings, specifications/line-item details, contract documents, addenda (if any), and the Proposal are all part of the Proposal package and Resultant Contract. **Proposals must be submitted in sets of five (5), one (1) single-sided unbound original, and four (4) single-sided copies**, on the forms provided by the County if County forms are provided and shall include the Proposal sheets completed in their entirety and signed by an authorized representative by original signature. Failure to complete and sign the Proposal sheets/contract page(s) may disqualify the Proposal from being considered by the Commissioners' Court. Any individual signing on behalf of the Proposer expressly affirms that he or she is duly authorized to tender this Proposal and to sign the Proposal under the terms and conditions in this request for Proposal on behalf of the Proposer and to bind the Proposer to the terms and conditions of this request for Proposal and the Proposer's response hereto.*

Proposer further understands that Proposers' signing of the contract shall be of no effect unless the contract is subsequently awarded by the Commissioners' Court and the contract properly executed by the Commissioners' Court.

All figures must be written in ink or typed. Figures written in pencil or with erasures are not acceptable. However, mistakes may be crossed out, corrections inserted, and initialed in ink by the individual signing the Proposal. If there are discrepancies between unit prices quoted and extensions, the unit price shall prevail.

Each Proposer is required to thoroughly review this entire Request for Proposal package to familiarize themselves with the Proposal procedures, the plans and specifications for the requested work, as well as the terms and conditions of the contract the successful Proposer will execute with the County.

2. PROPOSER'S RESPONSIBILITY

The Proposer must affirmatively demonstrate its responsibility. The Proposer must also meet the following minimum requirements:

- A. have adequate financial resources or the ability to obtain such resources as required;
- B. be able to comply with all federal, state, and local laws, rules, regulations, ordinances, and orders regarding this request for Proposal;
- C. have a satisfactory record of performance;
- D. have a satisfactory record of integrity and ethics; and
- E. be otherwise qualified and eligible to receive an award.

GENERAL PROVISIONS

REQUEST FOR PROPOSAL SEPTIC TANK SERVICES – RUNGE PARK GALVESTON COUNTY, TEXAS

3. TIME FOR RECEIVING PROPOSALS

Proposals may be submitted by mail or hand delivery and **must be submitted only to the Galveston County Purchasing Agent**. If by delivery, the Proposer must deliver the Proposal to the reception desk in the County Purchasing Agent's Office. The delivery and mailing instructions for the Galveston County Purchasing Agent are the following:

**Rufus Crowder, CPPO CPPB
Galveston County Purchasing Agent
722 Moody, Fifth (5th) Floor
Galveston, Texas 77550**

Proposals will **not** be accepted by facsimile transmission or by electronic mail (email) unless superseded by instructions within the Special Provisions section of this solicitation. Proposals must be received by the County Purchasing Agent on or before the deadline for the opening of the Proposals. **For clarity, mailing date/postmark is not sufficient – Proposals must be received by the County Purchasing Agent on or before the deadline.** Late Proposals will not be accepted and will be returned to the Proposer unopened. Proposals received prior to the submission deadline will be maintained unopened until the specified time for opening.

The County Purchasing Agent will accept Proposals from 8:00 a.m. to 5:00 p.m. on each business day up to the submission deadline. Business days do not include Saturdays and Sundays, and do not include other days in which the County is closed for business in observance of holidays or for other reasons.

The time-stamp clock within the County Purchasing Agent's Office shall be the official time clock for the purpose of this solicitation and thus shall be the determinant of whether the Proposal was timely received.

The Proposer should prominently identify the procurement number and name on the outside of the envelope/ mailing package. If the Proposer fails to identify the request for Proposal number and name on the outside of the envelope as required, the Purchasing Agent will open the envelope for the sole purpose of identifying the solicitation number for which the submission was made. The envelope will then be resealed. No liability will attach to a County office or employee for the premature opening of a Proposal.

If a Proposal is not submitted, return this Request for Proposal and state reason (s), otherwise your name may be removed from the Purchasing Agent's mailing list.

4. COMPETITIVENESS, INTEGRITY, INQUIRIES AND QUESTIONS

To prevent biased evaluations and to preserve the competitiveness and integrity of the procurement process, **Proposers are to direct all communications regarding this Request for Proposal only to the Galveston County Purchasing Agent**, unless otherwise specifically noted.

Do not contact the requesting department. Attempts by offering firms to circumvent this requirement will be viewed negatively and may result in rejection of the Proposal of the firm found to be in non-compliance.

GENERAL PROVISIONS

REQUEST FOR PROPOSAL SEPTIC TANK SERVICES – RUNGE PARK GALVESTON COUNTY, TEXAS

All questions regarding this Request for Proposal must be submitted in writing to:

Rufus Crowder, CPPO CPPB
Purchasing Agent
722 Moody
Fifth (5th) Floor
Galveston, Texas 77550
Fax: (409) 621-7997
E-mail: purchasing.bids@co.galveston.tx.us

All questions received and the responses thereto will be mailed, emailed, or faxed to all prospective Proposers by addendum. No inquiries except clarification of instructions will be addressed by telephone.

Proposer is advised to carefully review this Request for Proposal – it provides specific information necessary to aid participating firms in formulating a thorough response. Proposer's failure to examine all documents shall not entitle the Proposer to any relief from the conditions imposing in the Request for Proposal and the resultant contract.

An authorized person from the Proposer must sign the Proposal. This signatory must be a person from the submitting firm who is duly authorized to tender and sign the Proposal on behalf of the Proposer and to bind the Proposer to the terms and conditions of this Request for Proposal, the Proposer's response, and all other terms and conditions of the contract. By this signature, the Proposer further acknowledges that the Proposer has read the request for Proposal and Proposal documents thoroughly before submitting a Proposal and will fulfill the obligations in accordance with the terms, conditions, and specifications detailed herein.

5. PROPOSAL OPENING

The Purchasing Agent shall open the Proposals on the date and time specified herein. Proposals shall be opened in a manner that avoids disclosure of the contents to competing offerors and that keeps the Proposals secret during negotiations. The Purchasing Agent will examine Proposals promptly and thoroughly. **Upon opening, no Proposal may be withdrawn for a period of sixty (60) calendar days after the Proposal opening date.**

6. WITHDRAWAL OF PROPOSAL / FIRM PROPOSAL RULE

Proposers may request withdrawal of their sealed Proposal prior to the scheduled Proposal opening time provided the request for withdrawal is submitted to the Purchasing Agent in writing. No Proposals may be withdrawn for a period of sixty (60) calendar days after opening of the Proposals.

7. COMMISSIONERS' COURT

No contract is binding on the County until it is properly placed on the Commissioners' Court agenda, approved in open Court, authorized to be executed by the County Judge, and fully executed by both parties.

Department heads and elected officials are not authorized to enter into any type of agreement or contract on behalf of the County. Only the Commissioners' Court acting as a body may enter into a contract on behalf of and contractually bind the County. Additionally, department heads and elected officials are not authorized to agree to any type of supplemental agreements or contracts for goods or services.

GENERAL PROVISIONS

REQUEST FOR PROPOSAL SEPTIC TANK SERVICES – RUNGE PARK GALVESTON COUNTY, TEXAS

Supplemental agreements are subject to review by the County Legal Department prior to being accepted and signed by the County's authorized representative.

8. REJECTION OF PROPOSALS / DISQUALIFICATION

Galveston County, acting through its Commissioners' Court, reserves the right to:

- reject any and all Proposals in whole or in part received by reason of this request for Proposal;
- waive any informality in the Proposals received;
- disregard the Proposal of any Proposer determined to be not responsible;
- disregard the Proposal of any Proposer determined to have not submitted its Proposal timely; and/or
- discontinue its efforts for any reason under this request for Proposal package at any time prior to actual execution of contract by the County.

Proposers may be disqualified, and rejection of Proposals may be recommended to the Commissioners' Court for any of (but not limited to) the following causes:

- A. Failure to use the Proposal forms furnished by the County, if applicable;
- B. Lack of signature by an authorized representative of Proposer;
- C. Failure to properly complete the Proposal;
- D. Engaging in communications regarding this procurement during the pendency of this procurement with County officials and/or personnel who are not within the Purchasing Department;
- E. Failure to meet the mandatory requirements of this request for Proposal; and/or
- F. Evidence of collusion among Proposers.

9. RESTRICTIVE OR AMBIGUOUS SPECIFICATIONS

It is the responsibility of the prospective Proposer to review the entire request for Proposal packet and to notify the Purchasing Agent if the specifications are formulated in a manner that would restrict competition or appear ambiguous. Any protest or question(s) regarding the specifications or Proposal procedures must be received in the Purchasing Agent's Office not less than seventy-two (72) hours prior to the time set for Proposal opening. Proposers are to submit their Proposal as specified herein or propose an approved equal.

10. SUBSTITUTES / DESCRIPTION OF MATERIALS AND EQUIPMENT

Any brand name or manufacturer reference used herein is intended to be descriptive and not restrictive, unless otherwise noted, and is used to indicate the type and quality of material. The term "or equal" if used, identifies commercially produced items that have the essential performance and salient characteristics of the brand name stated in the item description. All supplies, material, or equipment shall be new and of the most suitable grade for the purpose intended. For clarification, "new" includes products containing recovered materials that are EPA-designated items and additionally see Section 63 of these General Provisions on contracts involving federal funds. It is not the County's intent to discriminate against any materials or equipment of equal merit to those specified. However, if Proposer desires to use any substitutions, prior written approval must be obtained from the Purchasing Agent and sufficiently in advance such that an addendum may be issued. All material supplied must be one hundred percent (100%) asbestos free. Proposer, by submission of its Proposal, certifies that if awarded any portion of this procurement, the Proposer will supply only material and equipment that is 100% asbestos free.

GENERAL PROVISIONS

REQUEST FOR PROPOSAL SEPTIC TANK SERVICES – RUNGE PARK GALVESTON COUNTY, TEXAS

11. EXCEPTIONS TO PROPOSAL CONDITIONS

The Proposer will list on a separate sheet of paper any exceptions to the conditions of this request for Proposal. This sheet will be labeled, “Exceptions to Proposal Conditions”, and will be attached to the Proposal. If no exceptions are stated, **it will be understood that all general and special conditions will be complied with, without exception.**

The Proposer must specify in its Proposal any alternatives it wishes to propose for consideration by the County. Each alternative should be sufficiently described and labeled within the Proposal and should indicate its possible or actual advantage to the program being offered.

The County reserves the right to offer these alternatives to other Proposers.

12. AWARDED PRICES

During the contractual period of the resultant contract, any prices submitted by the respondent shall include all costs to the County, including the material, delivery, current freight rate, state tax, or any other cost.

Award prices include all royalties and costs arising from patents, trademarks, and copyrights in any way involved in the work. Whenever the Awardee is required or desires to use any design, device, material or process covered by letters of patent or copyright, the Awardee shall indemnify and save harmless the County, its officers, agents and employees from any and all claims for infringement by reason of the use of any such patented design, tool, material, equipment, or process, to be performed under the contract, and shall indemnify the County its officers, agents, and employees for any costs, expenses and damages which may be incurred by reason of any infringement at any time during the prosecution or after the completion of the work.

Proposal pricing will be either lump sum or unit prices as shown on the Proposal sheets if included. The net priced items will be delivered to Galveston County, including all freight, shipping, and delivery charges. Galveston County is a tax-exempt local government of the State of Texas, therefore, no taxes shall be included with submitted pricing.

Cash discount must be shown on the Proposal, otherwise prices will be considered net. Unless prices and all information requested are complete, the Proposal may be disregarded and given no consideration.

In case of default by the contractor, the County of Galveston may procure the articles or services from other sources and may deduct from any monies due, or that may thereafter become due to the contractor, the difference between the price named in the contract of purchase order and the actual cost thereof to the County of Galveston. Prices paid by the County of Galveston shall be considered the prevailing market price at the time such purchase is made. Periods of performance may be extended if the facts as to the cause of delay justify such extension in the opinion of the Purchasing Agent and the Commissioners' Court.

13. PROCUREMENT CARD (P-CARD) PROGRAM

The County of Galveston participates in a Procurement Card (P-Card) program that allows payments made to a vendor by credit card. This method typically results in substantially faster bill payments, sometimes within three (3) to five (5) days of the actual transaction date. All transaction fees from the card provider are to be paid by the successful contractor. If awarded company will accept payment via credit card (Visa, MasterCard, etc.), this should be notated in the Proposal submittal.

GENERAL PROVISIONS

REQUEST FOR PROPOSAL SEPTIC TANK SERVICES – RUNGE PARK GALVESTON COUNTY, TEXAS

14. PASS THROUGH COST ADJUSTMENTS

Except in instances of extreme extenuating circumstances, Contractor prices shall remain firm throughout the contract period and any renewals. Examples of extreme extenuating circumstances include such situations as a nationwide rail strike, oil shortage or oil embargo.

In extreme extenuating circumstances, Contractors may be allowed to temporarily “pass through” additional costs they are forced to incur through no fault of their own. A request for a pass-through cost increase will not be considered unless a Contractor’s cost for the Contractor’s product exceeds 10% over the original cost for the product. Also, the increase in cost must be nationwide and consistent for a minimum period of sixty (60) calendar days. Costs that historically are anticipated to rise over a period of time (for example only, such as wages or insurance costs) do not qualify for pass through. If a Contractor thinks he will be asking for a pass-through cost adjustment during the term of the contract, then the original cost of the product to Contractor must be stated in Contractor’s original Proposal.

A request for a pass-through cost does not guarantee that one will be granted. Contractors must submit such information on each request as required by the County Purchasing Agent. The County Purchasing Agent will review each request on a case-by-case basis and if valid submit the request to the Commissioners’ Court for authorization and determination of the appropriateness of each request as well as amount and duration of increase. Contractors will not be permitted any additional compensation for mark-ups or profits based on the increase in price. Rather, such additional compensation will be limited to the actual increase in original cost to the Contractor as such increase is reflected by the original cost stated in the Proposal. But in no event will the amount of additional compensation exceed 25% increase in Contractor’s original cost for the product as such cost is reflected in Contractor’s original Proposal or the duration exceed a period of sixty (60) calendar days. In addition, should the cost, during the period of the pass through, return to normal or decrease to below pre pass through prices, appropriate downward adjustments shall be made. No more than one pass through adjustment will be permitted per year.

15. MODIFICATION OF PROPOSALS

A Proposer may modify a Proposal by letter at any time prior to the submission deadline for receipt of Proposals. Modification requests must be received by the Purchasing Agent prior to the submission deadline. Modifications made before opening time must be initialed by Proposer guaranteeing authenticity. Proposals may not be amended or altered after the official opening with the single exception that any product literature and/or supporting data required by the actual specifications, if any, will be accepted at any time prior to the Commissioners’ Court considering of same.

16. PRE-PROPOSAL CONFERENCE

A pre-Proposal conference for the purpose of discussing contract requirements and answering questions of prospective Proposers may be conducted in this procurement. A pre-Proposal conference may be mandatory or voluntary. If the pre-Proposal conference is mandatory, then the County is authorized to condition acceptance of a Proposal on compliance with attendance. The Special Provision section of this procurement shall specify if a pre-Proposal conference is to be held and shall specify whether the pre-Proposal conference is mandatory or voluntary. Regardless of whether the pre-Proposal conference is mandatory or voluntary, only a principal, officer, or employee of the Proposer may represent the Proposer at the pre-Proposal conference and no person may represent more than one Proposer at the pre-Proposal conference.

GENERAL PROVISIONS

REQUEST FOR PROPOSAL SEPTIC TANK SERVICES – RUNGE PARK GALVESTON COUNTY, TEXAS

17. SIGNATURE OF PROPOSALS

Each Proposal shall give the complete name of the Proposer and the mailing address of the Proposer and be signed by an authorized representative by original signature with the authorized representative's name and legal title typed below the signature line. Each Proposal shall include the Proposer's Federal Employer Identification Number (FEIN). Failure to sign the Contract page(s) and Proposal response sheets may disqualify the Proposal from being considered by the County. The person signing on behalf of the Proposer expressly affirms that the person is duly authorized to tender the Proposal on behalf of the Proposer and to sign the Proposal sheets and contract under the terms and conditions of this Request for Proposal and to bind the Proposer hereto and further understands that the signing of the contract shall be of no effect until it is properly placed on the Commissioners' Court agenda, approved in open Court, authorized to be executed by the County Judge, and fully executed by both parties.

18. AWARD OF PROPOSALS – EVALUATION CRITERIA AND FACTORS

The award will be made to the responsible Proposer whose Proposal is determined to be the lowest and best evaluated offer demonstrating the best ability to fulfill the requirements set forth in this Request for Proposal. **The proposed cost to the County will be considered firm and cannot be altered after the submission deadline, unless the County invokes its right to request a best and final offer.**

"Lowest and best" means a Proposal or offer providing the best value considering associated direct and indirect costs, including transport, maintenance, reliability, life cycle, warranties, and customer service after a sale.

In determining the lowest and best Proposal for a contract for the purchase of earth-moving, material-handling, road maintenance, or construction equipment, the Commissioners' Court may also consider the information submitted under Section 262.0255 of the Local Government Code; and in determining the lowest and best Proposal for a contract for the purchase of road construction material, the Commissioners' Court may consider the pickup and delivery locations of the Proposers and the cost to the county of delivering or hauling the material to be purchased. The Commissioners' Court may award contracts for the purchase of road construction material to more than one Proposer if each of the selected Proposers submits the lowest and best Proposal for a particular location or type of material.

Each Proposer, by submitting a Proposal, agrees that if its' Proposal is accepted by the Commissioners' Court, the Proposer will furnish all items and services upon which prices have been tendered and upon the terms and conditions in this Proposal, including but not limited to the best and final offer if applicable, and the contract.

The contractor shall commence work only after the transmittal of a fully executed contract and after receiving written notification to proceed from the County Purchasing Agent. The contractor will perform all services indicated in the Proposal in compliance with this contract.

Neither department heads nor elected officials are authorized to sign any binding contracts or agreements prior to being properly placed on the Commissioners' Court agenda and approved in open court. Department heads and other elected officials are not authorized to enter into any type of agreement or contract on behalf of Galveston County. Only the Commissioners' Court, acting as a body, may enter into a contract on behalf of the County. Additionally, department heads and other elected officials are not authorized to agree to any type of supplemental agreements or contracts for goods or services. Supplemental agreements are subject to review by the County's legal counsel prior to being signed by the County's authorized representatives.

GENERAL PROVISIONS

REQUEST FOR PROPOSAL SEPTIC TANK SERVICES – RUNGE PARK GALVESTON COUNTY, TEXAS

The County of Galveston reserves the right to accept Proposals on individual items listed, or group items, or on the Proposal as a whole; to reject any and all Proposals; to waive any informality in the Proposals; to disregard Proposals that are not submitted timely; to disregard the Proposals of Proposers determined to be not responsible; and to accept the Proposal that appears to be in the best interest of the County. The selection process may, however, include a request for additional information or an oral presentation to support the written Proposal.

In determining and evaluating the best Proposal, the pricing component may not necessarily be controlling, but quality, equality, efficiency, utility, general terms, delivery, suitability of the service offered, and the reputation of the service in general use will also be considered along with any other relevant items.

The County reserves the right to reject any or all Proposals in whole or in part received by reason of this Request for Proposal and may discontinue its efforts under this Request for Proposal for any reason or no reason or solely for the County's convenience at any time prior to actual execution of the contract by the County.

A Proposer whose Proposal does not meet the mandatory requirements set forth in this request for Proposal will be considered non-compliant.

The invitation to submit a Proposal which appears in the newspaper, or other authorized advertising mediums, these general provisions, the special specifications which follow, the Proposal sheets, forms, and any addenda issued are all considered part of the Proposal and resultant contract.

Each Proposer, by submitting a Proposal, agrees that if its Proposal is accepted by the Commissioners' Court, such Proposer will furnish all items and services upon the terms and conditions in this request for Proposal and the resultant contract.

Notice of contract award is anticipated to be made within ninety (90) days of opening of Proposals to the lowest responsive and responsible contractor, whose Proposal complies with all the requirements in the request for Proposal.

Contractor shall submit to the County, for approval, within ten (10) days from notice of contract award, all Certificates of Insurance evidencing the required coverage as described under Section 37, Requirement of and Proof of Insurance, or if different, then as described within the Special Provisions or resultant contract.

The contractor shall not commence work under these terms and conditions of the contract until all applicable Purchase Orders, Certificates of Insurance, Performance and Payment Bonds, and Irrevocable Letters of Credit (if required) have been approved by the County of Galveston and the Contractor has received notice to proceed in writing and an executed copy of the contract from the County Purchasing Agent.

19. DISPUTE AFTER AWARD / PROTEST

Any actual or prospective Proposer who is allegedly aggrieved in connection with this procurement or award of a contract resulting therefrom may protest. The protest shall be submitted in writing to the Purchasing Agent within seven (7) calendar days after such aggrieved person knows of or should have known of the facts giving rise thereto. If the protest is not resolved by mutual agreement, the Purchasing Agent will promptly issue a decision in writing to the protestant. If the protestant wishes to appeal the decision rendered by the Purchasing Agent, such appeal must be made to the Commissioners' Court

GENERAL PROVISIONS

REQUEST FOR PROPOSAL SEPTIC TANK SERVICES – RUNGE PARK GALVESTON COUNTY, TEXAS

through the Purchasing Agent. The decision of the Commissioners' Court will be final. The Commissioners' Court need not consider protests unless this procedure is followed.

20. PUBLIC INFORMATION ACT (f/k/a Open Records Act)

The Proposer acknowledges that the County is a government body for purposes of the Public Information Act, codified as Chapter 552 of the Texas Government Code, and as such is required to release information in accordance with the provisions of the Public Information Act.

If Proposer considers any of its submitted information to be proprietary in nature, trade secret, or otherwise confidential, then it must clearly and conspicuously mark such information as proprietary, trade, secret, or confidential. By the submission of its Proposal, Proposer expressly affirms that it has clearly and conspicuously marked any information within its submission that Proposer considers confidential, proprietary, and/or trade secret.

In the event the County receives a request for information under the Public Information Act seeking information that the Proposer has marked as confidential, proprietary, and /or trade secret, then the County agrees that it shall provide notice to the Proposer of the request for information and the request for decision process under the Public Information Act. Thus, the County will submit the initial correspondence to the Texas Attorney General – however, the burden is and shall be on the Proposer to submit correspondence to the Attorney General if the Proposer wishes its information to be withheld. Proposer is deemed to have knowledge of the Public Information Act. **By the submission of its Proposal, Proposer expressly acknowledges that the burden to withhold its' information from public disclosure lays with the Proposer;** thus, Proposer further acknowledges and agrees that it shall submit comments to the Texas Attorney General in the request for decision process if Proposer wishes to have its' information withheld from public disclosure.

21. PROPOSER'S E-MAIL ADDRESSES – CONSENT TO DISCLOSURE

Notwithstanding the foregoing Section 20, Proposer acknowledges and agrees that the confidentiality of any and all email addresses Proposer uses or discloses in communicating with the County are **open** to the public in accordance with Section 552.137 of the Government Code and Proposer consents to the release of its email addresses.

22. RESULTANT CONTRACT

Proposer should submit a proposed contract / agreement with its response, or its sample material terms and conditions for review and consideration.

It is the intent of this solicitation to enter a contract that meets State and Federal guidelines. It is imperative that all responders seeking a contract under this solicitation effort, familiarize and adhere to the requirements of the General Provisions, Special Provisions, and the procurement standards as referenced in 2 C.F.R. Part 200, Sections 200.317-200.326, and Appendix II, 2 C.F.R. Part 200. Sections 200.317–200.326 and Appendix II are referenced in the General Provisions section of this solicitation.

The resultant contract consists of the following documents: Request for Proposal, General Provisions, Special Provisions, General Terms and Conditions (including specifications, drawings, and addenda), Proposer's Proposal, Proposal Sheets, contract award, and any other documents referenced herein or

GENERAL PROVISIONS

REQUEST FOR PROPOSAL SEPTIC TANK SERVICES – RUNGE PARK GALVESTON COUNTY, TEXAS

attached hereto for the work. Collectively these documents may also be referred to as the Plans and Specifications.

The Galveston County Commissioners Court, and/or authorized designees will be responsible for negotiating with the successful contractor, the scope of work, the standards of performance, the specific technology provided, and the support services required for the proposed projects. All contractual amendments will be processed in accordance with Galveston County Purchasing Policies and Procedures.

Amendments will also be brought to Galveston County Commissioners' Court for approval as deemed necessary. The approval process serves to ensure the project technology and/or service is within the scope of the resultant contract, and that pricing meets the agreed upon pricing methodology as specified in the contract, and that funds are available.

Proposer shall correctly and fully execute the resultant contract first. After this, the contract shall be set for consideration by the Commissioners' Court. If the Commissioners' Court authorizes the execution of the contract, the resultant contract shall become effective upon the Commissioners' Court execution of same, provided that the contract is executed by all parties to the contract. Contract documents shall consist of the contract, the General and Special Provisions, drawings, solicitation package (including best and final offer(s) if such is utilized), any addenda issued, and any change orders issued during the work. If applicable to the attached Proposal, Proposer must sign three (3) original contracts and return all three with their Proposal submittal.

The Contractor shall procure all permits, licenses, certificates, or any such approvals of plans or specifications as may be required by federal, state, and local laws, ordinances, rules, and regulations, for the proper execution and completion of the work under the resultant agreement.

The Contractor is responsible for all damage or loss by fire, theft or otherwise, to materials, tools, equipment, and consumables, left on County property by the contractor.

The resultant agreement is considered a non-exclusive agreement between the parties.

The successful contractor hereby certifies that this agreement is made without prior understanding, agreement or connection with any corporation, firm or person who submitted Proposals for the Work covered by

The resultant agreement and is in all respects fair and without collusion or fraud. As to Contractor, the successful contractor hereby warrants and certifies that he/she is authorized to enter into this agreement and to execute same on behalf of the Contractor as the act of the said Contractor.

The agreement, including the General and Special Conditions and all amendments or addenda issued by the county, contains all the terms and conditions agreed upon by the parties. No other agreements, oral or otherwise, regarding the subject matter of the resultant agreement shall be deemed to exist or to bind either party hereto.

To satisfy cost reasonableness responsibilities at the time of any extension period, the County of Galveston reserves the right to obtain additional quotes and current pricing information from the successful contractor and other contractors to perform the work as stated per the specification listed herein and in the resultant. The solicited results may be used by the County to determine if the contract extensions will be considered, or other service options be utilized.

GENERAL PROVISIONS

REQUEST FOR PROPOSAL SEPTIC TANK SERVICES – RUNGE PARK GALVESTON COUNTY, TEXAS

23. CONTRACT TERM

The term of the resultant contract will begin on the date of full execution or the execution by the Commissioners' Court, whichever is later, and will terminate on the date specified in the resultant contract unless terminated earlier as herein set forth.

24. COLLATERAL CONTRACT

The County reserves the right to provide by separate contract or otherwise, in such manner as not to delay its programs or damage said Contractor, all labor and material essential to the completion of the work that is not included in this contract.

Award prices include all royalties and costs arising from patents, trademarks, and copyrights in any way involved in the work. Whenever the Awardee is required or desires to use any design, device, material or process covered by letters of patent or copyright, the Awardee shall indemnify and save harmless the County, its officers, agents and employees from any and all claims for infringement by reason of the use of any such patented design, tool, material, equipment, or process, to be performed under the contract, and shall indemnify the County its officers, agents, and employees for any costs, expenses and damages which may be incurred by reason of any infringement at any time during the prosecution or after the completion of the work.

25. TERMINATION FOR DEFAULT

Failure of either party in the performance of any of the provisions of this contract shall constitute a breach of contract, in which case either party may require corrective action within ten (10) business days from date of receipt of written notice citing the exact nature of such breach. Failure of the party being notified to take corrective action within the prescribed ten (10) business days, or failure to provide written reply of why no breach has occurred, shall constitute a Default of Contract.

All notices relating to default by Proposer of the provisions of the contract shall be issued by the County through its Legal counsel, and all replies shall be made in writing to the County's legal counsel. Notices issued by or issued to anyone other than the County's legal counsel shall be null and void and shall be considered as not having been issued or received.

Galveston County reserves the right to enforce the performance of this contract in any manner prescribed by law in the event of breach or default of this contract, and may contract with another party, with or without solicitation of Proposals or further negotiations. At a minimum, Proposer shall be required to pay any difference in service or materials, should it become necessary to contract with another source, plus reasonable administrative costs, and attorney fees.

In the event of Termination for Default, Galveston County, its agents, or representatives shall not be liable for loss of any profits anticipated to be made by Proposer.

In addition to the remedies stated herein, the County has the right to pursue other remedies permitted by law or in equity.

No waiver by either party of any event of default under this agreement shall operate as a waiver of any subsequent default under the terms of this agreement.

County reserves the right to terminate this contract immediately in the event Proposer:

GENERAL PROVISIONS

REQUEST FOR PROPOSAL SEPTIC TANK SERVICES – RUNGE PARK GALVESTON COUNTY, TEXAS

- A. Fails to meet delivery or completion schedules; and/or
- B. Fails to otherwise perform in accordance with the accepted Proposal and the contract.

26. TERMINATION FOR CONVENIENCE

County may terminate this contract upon at least thirty (30) calendar days prior written notice for its convenience or for any reason deemed by the County to serve the public interest. As well, County may terminate this contract upon thirty (30) calendar days prior written notice for any reason resulting from any governmental law, order, ordinance, regulation, or court order. In no event shall County be liable for loss of any profits anticipated to be made hereunder by Proposer should this contract be terminated early.

27. FORCE MAJEURE

If by reason of Force Majeure either Party shall be rendered unable, wholly or in part, to carry out its responsibilities under this contract by any occurrence by reason of Force Majeure, then the Party unable to carry out its responsibility shall give the other Party notice and full particulars of such Force Majeure in writing within a reasonable time after the occurrence of the event, and such notice shall suspend the Party's responsibility for the continuance of the Force Majeure claimed, but for no longer period.

Force Majeure means acts of God, floods, hurricanes, tropical storms, tornadoes, earthquakes, or other natural disasters, acts of a public enemy, acts of terrorism, sovereign conduct, riots, civil commotion, strikes or lockouts, and other causes that are not occasioned by either Party's conduct which by the exercise of due diligence the Party is unable to overcome, and which substantially interferes with operations.

28. ESTIMATED QUANTITIES

Any reference to quantities shown in the request for Proposal is an estimate only. Since the exact quantities cannot be predetermined, the County reserves the right to adjust quantities as deemed necessary to meet its requirements.

29. CONTRACTOR INVESTIGATION

Before submitting a Proposal, each Proposer shall make all investigations and examinations necessary to ascertain all site conditions and requirements affecting the full performance of the contract and to verify any representations made by the County upon which the contractor will rely. Proposer shall exercise due diligence and is further charged with knowledge of the local, State, and Federal laws, rules, and regulations applicable to this contract. If the Proposer receives an award as a result of its Proposal submission in this procurement, the Proposer's failure to have made such investigations and examinations will in no way relieve the Proposer from its obligation to comply in every detail with all provisions and requirements of the contract, nor will a plea of ignorance of such conditions and requirements be accepted as a basis for any claim whatsoever by the contractor for additional compensation and/or for excused nonperformance.

30. NO COMMITMENT BY COUNTY OF GALVESTON

This request for procurement does not commit the County of Galveston to award any costs or pay any costs, or to award any contract, or to pay any costs associated with or incurred in the preparation of a Proposal in response to this request for Proposal and does not commit the County of Galveston to procure or contract for services or supplies.

GENERAL PROVISIONS

REQUEST FOR PROPOSAL SEPTIC TANK SERVICES – RUNGE PARK GALVESTON COUNTY, TEXAS

31. PROPOSAL COSTS BORNE BY PROPOSER

Galveston County shall not be liable for any costs incurred by Proposer in preparation, production, or submission of a Proposal, including but not limited to best and final offer if applicable. As well, Galveston County shall not be liable for any work performed by Proposer prior to issuance of fully executed contract and properly issued notice to proceed. Galveston County shall not be liable for any costs incurred by Proposer by reason of attending a pre-Proposal conference. Galveston County shall not be liable for any costs incurred by Proposer by reason of the County invoking use of best and final offers.

32. BEST AND FINAL OFFERS (BAFO)

In acceptance of Proposals, the County reserves the right to negotiate further with one or more of the Proposers as to any features of their Proposals and to accept modifications of the work and price when such action will be in the best interest of the County. This includes, but is not limited to, the solicitation of a Best and Final Offer from one or more of the Proposers. If a Best and Final Offer is invoked, this allows acceptable Proposers the opportunity to amend, change, or supplement their original Proposal. Proposers may be contacted in writing by the Purchasing Agent, requesting that they submit their Best and Final Offer. Any such Best and Final Offer must include discussed and negotiated changes.

33. SINGLE PROPOSAL RESPONSE

If only one Proposal is received in response to the request for Proposal, a detailed cost Proposal may be requested of the single Proposer. A cost/price analysis and evaluation and/or audit may be performed of the cost Proposal to determine if the price is fair and reasonable.

34. CHANGES IN SPECIFICATIONS

If it becomes necessary to revise any part of this Request for Proposal, a written notice of such revision will be provided to all Proposers in the form of addenda. The County is not bound by any oral representations, clarifications, or changes made in the written specifications by the County's employees or officials, unless such clarification or change is provided to Proposers in a written addendum from the Purchasing Agent. Proposers are advised to inquire prior to the submission deadline as to whether any addenda to this request for Proposal have been issued, as the successful Proposer will be required to abide by such addenda.

The County of Galveston reserves the right to revise or amend the specifications up to the time set for opening of Proposals. Such revisions and amendments, if any, shall be announced by form of addenda. Copies of such addenda (or addendum in the event only one addendum is issued in the procurement) shall be furnished to all prospective contractors. Prospective contractors are defined as those contractors listed on the County's request for proposal list for this material/service or those who have obtained documents from the Purchasing Agent's Office subsequent to the advertisement. If revisions and amendments require changes in quantities or prices proposed, or both, the date set for opening of Proposals may be postponed by such number of days as in the opinion of the County shall enable prospective contractors to revise their Proposals. In any case, the Proposal opening shall be at least seven (7) business days after the last revising or amendment addendum and the addendum shall include an announcement of the new date, if applicable, for the opening of Proposals.

35. PROPOSAL IDEAS AND CONCEPTS

The County reserves to itself the right to adopt or use for its benefit, any concept, plan, or idea contained in any Proposal.

GENERAL PROVISIONS

REQUEST FOR PROPOSAL SEPTIC TANK SERVICES – RUNGE PARK GALVESTON COUNTY, TEXAS

36. PROPOSAL DISCLOSURES

While this procurement is pending, the names of those who submitted Proposals will not be made public unless in conformity with the County Purchasing Act. Likewise, no pricing, staffing, or other contents of the Proposal information will be released unless in conformity with the County Purchasing Act. Proposers are requested to withhold all inquiries regarding their Proposal or other submissions until after an award is made. No communication is to be had with any County employee or official, other than the County Purchasing Agent, regarding whether a Proposal was received - violations of this provision may result in the rejection of a Proposal.

37. INDEMNIFICATION

The contractor agrees to assume all risks and responsibility for, and agrees to indemnify, defend, and save harmless, the County of Galveston, its elected and appointed officials and department heads, and its agents and employees from and against all claims, demands, suits, actions, recoveries, judgments, and costs and expenses including reasonable attorney's fees for the defense thereof, arising out of or in connection therewith on account of the loss of life, property or injury or damage to the person which shall arise from contractor's operations under this contract, its use of County facilities and/or equipment or from any other breach on the part of the contractor, its employees, agents or any person(s), in or about the County's facilities with the expressed or implied consent of the County. Contractor shall pay any judgment with cost which may be obtained against Galveston County resulting from contractor's operations under this contract.

Contractor agrees to indemnify and hold the County harmless from all claims of subcontractors, laborers incurred in the performance of this contract. Contractor shall furnish satisfactory evidence that all obligations of this nature herein above designated have been paid, discharged or waived. If Contractor fails to do so, then the County reserves the right to pay unpaid bills of which County has written notice direct and withhold from Contractor's unpaid compensation a sum of money reasonably sufficient to liquidate any and all such lawful claims.

38. REQUIREMENT OF AND PROOF OF INSURANCE

The successful Proposer shall furnish evidence of insurance to the County Purchasing Agent and shall maintain such insurance as required hereunder or as may be required in the Special Provisions or resultant contract, if different. Contractor shall obtain and thereafter continuously maintain in full force and effect, Commercial General Liability insurance, including but not limited to bodily injury, property damage, and contractual liability, with combined single limits as listed below or as may be required by State or Federal law, whichever is greater.

- A. For damages arising out of bodily injury to or death of one person in any one accident:
ONE HUNDRED THOUSAND AND NO/100 (\$100,000.00) DOLLARS.
- B. For damages arising out of bodily injury to or death of two or more persons in any one accident:
THREE HUNDRED THOUSAND AND NO/100 (\$300,000.00) DOLLARS.
- C. For any injury to or destruction of property in any one accident:
ONE HUNDRED THOUSAND AND NO/100 (\$100,000.00) DOLLARS.

Insurance shall be placed with insurers having an A.M. Best's rating of no less than A. Such insurance must be issued by a casualty company authorized to do business in the State of Texas, and in

GENERAL PROVISIONS

REQUEST FOR PROPOSAL SEPTIC TANK SERVICES – RUNGE PARK GALVESTON COUNTY, TEXAS

standard form approved by the Board of Insurance Commissioners of the State of Texas, with coverage provisions ensuring the public from loss or damage that may arise to any person or property by reason of services rendered by Contractor.

Galveston County shall be listed as the additional insured on policy certificates and shall be provided with no less than thirty (30) calendar days prior notice of any changes to the policy during the contractual period.

Certificates of Insurance, fully executed by a licensed representative of the insurance company written or countersigned by an authorized Texas state agency, shall be filed with the County Purchasing Agent within ten (10) business days of issuance of notification from the County Purchasing Agent to Proposer that the contract is being activated as written proof of such insurance and further provided that Proposer shall not commence work under this contract until it has obtained all insurance required herein, provided written proof as required herein, and received written notice to proceed issued from the County Purchasing Agent.

Proof of renewal/replacement coverage shall be provided prior to the expiration, termination, or cancellation date of any policy and Galveston County shall be named as an additional insured on any such renewal/replacement coverage and a certificate of insurance showing such shall be provided to the Purchasing Agent. Said insurance shall not be cancelled, permitted to expire, or changed without at least thirty (30) days prior written notice to the County.

Insurance required herein shall be maintained in full force and effect during the life of this contract and shall be issued on an occurrence basis. Contractor shall require that any and all subcontractors that are not protected under the Contractor's own insurance policies take and maintain insurance of the same nature and in the same amounts as required of Contractor and provide written proof of such insurance to Contractor. Proof of renewed/replacement coverage shall be provided prior to the expiration, termination, or cancellation date of any policy. Contractor shall not allow any subcontractor to commence work on the subcontract until such insurance required for the subcontractor has been obtained and approved.

Workers' Compensation Insurance: Successful Proposer shall carry in full force Workers' Compensation Insurance Policy(ies), if there is more than one employee, for all its' employees, including but not limited to full time, part time, and emergency employees employed by the successful Proposer. Current insurance certificates certifying that such policies as specified above are in full force and effect shall be furnished by successful Proposer to the County.

Insurance is to be placed with insurers having a Best rating of no less than A. The Proposer shall furnish the County with certificates of insurance and original endorsements affecting coverage required by these insurance clauses within ten (10) business days of receiving notification from the County Purchasing Agent that the contract is being activated. The certificates and endorsements for each insurance policy are to be signed by a person authorized by the insurer to bind coverage on its behalf. The Proposer shall be required to submit annual renewals for the term of this contract prior to expiration of any policy.

In addition to the remedies stated herein, the County has the right to pursue other remedies permitted by law or in equity.

The County agrees to provide Proposer with reasonable and timely notice of any claim, demand, or cause of action made or brought against the County arising out of or related to utilization of the property. Proposer shall have the right to defend any such claim, demand, or cause of action at its sole cost and expense and within its sole and exclusive discretion. The County agrees not to compromise or settle any

GENERAL PROVISIONS

REQUEST FOR PROPOSAL SEPTIC TANK SERVICES – RUNGE PARK GALVESTON COUNTY, TEXAS

claim or cause of action arising out of or related to the utilization of the property without the prior written consent of the Proposer.

In no event shall the County be liable for any damage to or destruction of any property belonging to the Proposer.

Subrogation Waiver. Proposer and Proposer's insurance carrier waive any and all rights to subrogation against Galveston County in regard to any suit or claim arising out of personal injury or property damage resulting from Proposer's performance under this agreement.

39. PROPOSAL GUARANTEE

Unless specified differently within the Special Provisions of this procurement, each Proposer shall be required to submit a Proposal guarantee with its Proposal as required within this Section.

Evidencing its firm commitment to engage in contract if Proposer is selected for award of contract, each Proposer is required to furnish with their Proposal a cashier's check or an acceptable Proposer's bond (generally, a Proposal bond) in the amount of five percent (5%) of the total contract price. If Proposer is using a bond, then the bond must be executed with a surety company authorized to do business in the State of Texas. Failure to furnish the Proposal guarantee in the proper form and amount, by the time set for opening of Proposals may be cause for rejection of the Proposal.

The cashier's check or Proposer bond (as applicable) will be returned to each respective unsuccessful Proposer(s) after the Commissioners' Court award of contract and shall be returned to the successful Proposer upon the completion and submission of all contract documents. Provided however, that the cashier's check or Proposer bond will be forfeited to the County as liquidated damages should successful Proposer fail to execute the contract within thirty (30) days after receiving notice of the acceptance of its Proposal.

40. PERFORMANCE AND PAYMENT BONDS (if required)

Successful Proposer, before beginning work, shall execute a performance bond and a payment bond, each of which must be in the amount of the contract. The required payment and performance bonds must each be executed by a corporate surety authorized to write surety bonds in the State of Texas and in accordance with Chapter 3503 of the Insurance Code (codified in 2005 and originally within Section 1, Chapter 87, Acts of the 56th Leg., R.S., 1959, and in Article 7.19-1, Vernon's Texas Insurance Code).

The performance and payment bonds must each clearly and prominently display on the bond or on an attachment to the bond:

- a.) The name, mailing address, physical address, and telephone number, including the area code, of the surety company to which any notice of claim should be sent; or
- b.) The toll-free telephone number maintained by the Texas Department of Insurance under Subchapter B, Chapter 521, Insurance Code, and a statement that the address of the surety company to which any notice of claim should be sent may be obtained from the Texas Department of Insurance by calling the toll free-telephone number.

GENERAL PROVISIONS

REQUEST FOR PROPOSAL SEPTIC TANK SERVICES – RUNGE PARK GALVESTON COUNTY, TEXAS

The performance bond shall be solely for the protection of Galveston County, in the full amount of the contract, and conditioned on the faithful performance of the work in accordance with the plans, specifications, and contract documents. The payment bond is solely for the protection and use of payment bond beneficiaries who have a direct contractual relationship with the prime contractor or a subcontractor to supply labor or material, and in the amount of the contract.

The payment and performance bonds required to be furnished herein must be furnished before the contractor begins work and are a requirement for issuance of a Notice to Proceed. Such bonds must be furnished to the Galveston County Purchasing Agent within thirty (30) calendar days after the date of the full execution of the contract or, if applicable, as required under Chapter 2253, Government Code, whichever is earlier. Contractor's failure to provide the required payment and performance bonds within such time period shall constitute an event of default under this contract. Contractor shall not commence work until all applicable certificates of insurance, performance bonds, and payment bonds have been received and approved by the County Purchasing Agent and the Contractor receives notice to proceed in writing that has been issued by the County Purchasing Agent.

Additionally, if this request for Proposal is for the award of a public works contract, then compliance with Chapter 2253 of the Texas Government Code, which is known as the McGregor Act, is mandatory. Performance and payment bonds are required to be furnished in accordance with Chapter 2253 of the Texas Government Code. Proposer should familiarize itself with the entire provisions of Chapter 2253 of the Texas Government Code.

41. PATENT AND COPYRIGHT PROTECTION

The Proposer agrees at its sole expense to protect the County from claims involving infringement of patents, copyright, trademark, trade secret, or other intellectual property rights. **Proposer shall indemnify and save harmless the County of Galveston, its officers, employees, and agents, from liability of any nature and kind whatsoever, including without limitation cost and expenses, for or on account of any copyrighted, trademarked, trade secret, patented or un-patented invention, process, or article manufactured or used in the performance of the contract, or other intellectual property rights, including its use by the County.** Proposer also agrees that if Proposer is awarded this contract, that no work performed hereunder shall be subject to patent, copyright, or other intellectual property by Proposer.

42. CONFLICT OF INTEREST DISCLOSURE REPORTING (FORM CIQ)

Proposer may be required under Chapter 176 of the Texas Local Government Code to complete and file a Conflict-of-Interest Questionnaire (CIQ Form). The CIQ Form pertains to business relationship, gift giving and family relationship reporting. If Proposer is required to file a CIQ Form, then **the completed CIQ Form must be filed with the County Clerk of Galveston County, Texas.**

Business relationship. If Proposer has an employment or other business relationship with a local government officer of Galveston County or with a family member of a local government officer of Galveston County that results in the officer or family member of the officer receiving taxable income that exceeds \$2,500.00 during the preceding 12-month period, then Proposer **MUST** complete a CIQ Form and file the original of the CIQ Form with the County Clerk of Galveston County.

Gift-giving. If Proposer has given a local government officer of Galveston County or a family member of a local government officer of Galveston County one or more gifts with an aggregate value of more than

GENERAL PROVISIONS

REQUEST FOR PROPOSAL SEPTIC TANK SERVICES – RUNGE PARK GALVESTON COUNTY, TEXAS

one-hundred dollars (\$100.00) during the preceding 12-months, then Proposer **MUST** complete a CIQ Form and file the original of the CIQ Form with the County Clerk of Galveston County.

Family member. For purposes of the business relationship and gift giving reporting requirements, a “family member” means a person related to another person with the first degree of consanguinity or affinity, as described by Subchapter B, Chapter 573, Texas Government Code. Examples of persons within the first degree by consanguinity or affinity include a son, daughter, father, mother, spouse, son-in-law, daughter-in-law, father-in-law, mother-in-law, stepson, stepdaughter, stepmother, and stepfather.

Family relationship. If Proposer has a “family relationship” with a local government officer of Galveston County then Proposer **MUST** complete a CIQ Form and file the original of the CIQ Form with the County Clerk of Galveston County, regardless of whether Proposer has a business relationship or has given gifts to the local government officer or a family member of the local government officer. For this purpose, “family relationship” means Proposer is related within the third degree by consanguinity or the second degree by affinity, as those terms are defined under Chapter 573 of the Texas Government Code, to a local government officer of Galveston County. Examples of such relationships include a son, daughter, mother, father, brother, sister, grandchild, great-grandchild, grandparent, great-grandparent, niece, nephew, uncle, aunt, spouse, mother-in-law, father-in-law, daughter-in-law, son-in-law, spouse’s grandchild, spouse’s grandparent, grandparent’s spouse, grandchild’s spouse, stepson, stepdaughter, stepmother, and stepfather.

Proposer must file its original CIQ Form with the Galveston County Clerk. The Galveston County Clerk has offices at the following locations:

Galveston County Clerk
Galveston County Justice Center, Suite 2001
600 59th Street
Galveston, Texas 77551

Galveston County Clerk
North County Annex, 1st Floor
174 Calder Road
League City, Texas 77573

Again, if Proposer is required to file a CIQ Form, the original completed form is filed with the Galveston County Clerk (**not the Purchasing Agent**).

For Proposer’s convenience, a blank CIQ Form is enclosed with this Proposal package. Blank CIQ Form(s) may also be obtained by visiting the Purchasing Agent’s website. This website is linked from the Galveston County homepage, at <http://www.galvestoncountytexas.gov>.

Chapter 176 specifies deadlines for the filing of CIQ Forms (both initial filings and updated filings).

It is Proposer’s sole responsibility to file a true and complete CIQ Form with the Galveston County Clerk if Proposer is required to file by the requirements of Chapter 176 of the Local Government Code. Proposer is advised that it is an offense to fail to comply with the disclosure reporting requirements dictated under Chapter 176 of the Texas Local Government Code, and the failure to file may be grounds to void the contract, if Proposer is awarded a contract.

GENERAL PROVISIONS

REQUEST FOR PROPOSAL SEPTIC TANK SERVICES – RUNGE PARK GALVESTON COUNTY, TEXAS

If Proposer has any questions about compliance with Chapter 176, Proposer may wish to consult its' legal counsel. Compliance is the individual responsibility of each person, business, and agent who is subject to Chapter 176 of the Texas Local Government Code.

43. DISCLOSURE OF INTERESTED PARTIES / FORM 1295

Under Section 2252.908 of the Government Code, any business entity that enters into a contract with Galveston County that requires the approval of the Commissioners' Court must submit a "Disclosure of Interested Parties" to the County prior to the execution of the contract. This form, the "Disclosure of Interested Parties" form was promulgated by the Texas Ethics Commission and is the "Form 1295". **This procurement is subject to these requirements.**

The Texas Ethics Commission was charged with promulgating rules to implement Section 2252.908 of the Government Code. The rules adopted by the Texas Ethics Commission are located at Sections 46.1, 46.3, and 46.5 of Title 1 of the Texas Administrative Code. Thus, the law covering these requirements is located at Section 2252.908 of the Government Code, and in Title 1, Sections 46.1, 46.3, and 46.5 of the Texas Administrative Code.

The Texas Ethics Commission's website is: www.ethics.state.tx.us. The area of the Texas Ethics Commission website pertaining to Form 1295 is:

www.ethics.state.tx.us/whatsnew/elf_info_form1295.htm.

Form 1295 must be completed electronically through the Texas Ethics Commission website (handwritten forms are not allowable). Once the business entity has completed their electronic filing of Form 1295, then the business entity must print out the electronically completed form, and sign and notarize the Form 1295. Once Form 1295 is signed and notarized, the business entity must submit their completed, signed, and notarized Form 1295 to the Galveston County Purchasing Agent.

Successful Proposer is and shall be subject to these requirements, and no resultant contract may be executed by the Commissioners' Court until the completed, signed, and notarized Form 1295 is on file with the County Purchasing Agent.

No portion of the Form 1295 process commits the County to any type of award of contract whatsoever.

After the Purchasing Agent's Office receives the completed, signed, and notarized Form 1295, the Purchasing Department representative will, within 30 days, go to the Texas Ethics Commission website to submit electronic confirmation of the County's receipt of the completed, signed, and notarized Form 1295.

44. CERTIFICATION REGARDING DEBARMENT, SUSPENSION, PROPOSED DEBARMENT, AND OTHER RESPONSIBILITY MATTERS & REQUIREMENT TO REGISTER IN SAM

Proposer certifies that neither it, nor any of its Principals, are presently debarred, suspended, proposed for debarment, disqualified, excluded, or in any way declared ineligible for the award of contracts by any Federal agency. Contractor agrees that it shall refund Galveston County for any payments made to Contractor while ineligible. Contractor acknowledges that Contractor's uncured failure to perform under this Agreement, if such should occur, may result in Contractor being debarred from performing additional work for the County, the respecting State Agency administering the grant funding the contract, if

GENERAL PROVISIONS

REQUEST FOR PROPOSAL SEPTIC TANK SERVICES – RUNGE PARK GALVESTON COUNTY, TEXAS

applicable, the State, FEMA, or HUD (as applicable), and other Federal and State entities. Further, Proposer has executed the Certification Regarding Debarment, Suspension, Proposed Debarment, and Other Responsibility Matters and returned the fully completed and executed original certification with the submission of its Proposal.

The truthful and fully completed and executed original of the Certification Regarding Debarment, Suspension, Proposed Debarment, and Other Responsibility Matters must be included with the submission of Proposer's Proposal and is a mandatory requirement of this request for Proposal. Proposer's failure to include the fully completed and executed original of this Certification shall be considered non-compliance with the requirements of this request for Proposal and grounds for the rejection of Proposer's Proposal.

Proposer shall immediately notify the County Purchasing Agent if it becomes debarred or suspended, placed on the Consolidated List of Debarred Contractors, or in any other way becomes ineligible for award of contract by any Federal agency. This Certification is a material fact relied upon by Galveston County; if it is later determined that the contractor did not comply with 2 C.F.R. Part 180 and 2 C.F.R. Part 3000, in addition to the remedies available to Galveston County and the State agency administering this grant, the Federal Government may pursue available remedies, including but not limited to suspension and/or debarment of contractor.

If the contract to be awarded pursuant to this procurement involves the use of Federal funds, then Proposer must also be registered in the Federal Contractor Registry through the System for Award Management (SAM) to be eligible for award of contract pursuant to this procurement.

Information regarding the SAM is available at:

<http://www.federalcontractorregistry.com/?gclid=CIG1hf2rr8wCFYkCaQoducANZw> or at
<https://www.sam.gov/portal/SAM/#1>.

No contract involving the use of Federal funds may be awarded to any Proposer unless and until such registration is current and in good standing under SAM. Successful Proposer must maintain SAM registration throughout the entire term of the agreement with the County. If this contract involves the use of Federal funds, then Proposer must enclose proof of such SAM registration within its response, which is also a mandatory requirement of this procurement; failure to enclose such proof shall be considered non-compliance with the requirements of this procurement and grounds for the rejection of Proposer's response to this procurement (i.e., Proposal, Proposal, or qualifications statement, as applicable).

45. TRANSACTIONS WITH TERRORIST ORGANIZATIONS PROHIBITED

(Texas Government Code 2252.151; 2252.152) Prohibition on contracts with certain companies per Government Code 2252.151 Definitions:

(1)“**Company**” has the meaning assigned by Section 806.001.

(2)“**Foreign terrorist organization**” means an organization designated as a foreign terrorist organization by the United States secretary of state as authorized by 8 U.S.C. Section 1189.

GENERAL PROVISIONS

REQUEST FOR PROPOSAL SEPTIC TANK SERVICES – RUNGE PARK GALVESTON COUNTY, TEXAS

(3)“**Governmental contract**” means a contract awarded by a governmental entity for general construction, an improvement, a service, or a public works project for a purchase of supplies, materials, or equipment. The term includes a contract to obtain a professional or consulting service subject to Government Code, Chapter 2254.

(4)“**Governmental entity**” has the meaning assigned by Government Code, Section 2252.001.

Pursuant to Chapter 2252, Texas Government Code, Contractor shall certify that, at the time of execution of this Contract, neither the Contractor, nor any wholly owned subsidiary, majority-owned subsidiary, parent company or affiliate of the same (1) engages in business with Iran, Sudan, or any foreign terrorist organization as described in Chapters 806 or 807 of the Texas Government Code, or Subchapter F of Chapter 2252 of the Texas Government Code, or (2) is a company listed by the Texas Comptroller of Public Accounts under Sections 806.051, 807.051, or 2252.153 of the Texas Government Code.

46. VERIFICATION NOT TO BOYCOTT ISRAEL

Prohibition on contracts with companies boycotting Israel per Government Code 2271.001 Definitions:

(1) "**Boycott Israel**" has the meaning assigned by Section 808.001.

(2) "**Company**" has the meaning assigned by Section 808.001; except that the term does not include a sole proprietorship.

(2) "**Governmental entity**" has the meaning assigned by Government Code, Section 2251.001.

PROVISION REQUIRED IN CONTRACT. (a) This section applies only to a contract that:

(1) is between a governmental entity and a company with 10 or more full-time employees; and

(2) has a value of \$100,000 or more that is to be paid wholly or partly from public funds of the governmental entity.

(b) A governmental entity may not enter into a contract with a company for goods or services unless the contract contains a written verification from the company that it:

(1) does not boycott Israel; and

(2) will not boycott Israel during the term of the contract.

As required by GOVERNMENT CODE, CHAPTER 2271, **CONTRACTOR hereby verifies that it does not boycott Israel and will not boycott Israel throughout the term of this Agreement.** For the purposes of this verification, “Boycott Israel” means refusing to deal with, terminating business activities, or otherwise taking any action that is intended to penalize, inflict economic harm on, or limit commercial relations specifically with Israel, or a person or entity doing business in Israel or in an Israeli-controlled territory, but does not include an action made for ordinary business purposes.

47. SOVEREIGN IMMUNITY

The County specifically reserves any claim it may have to sovereign, qualified, or official immunity as a defense to any action arising in conjunction with this contract.

GENERAL PROVISIONS

REQUEST FOR PROPOSAL SEPTIC TANK SERVICES – RUNGE PARK GALVESTON COUNTY, TEXAS

48. CONTROLLING LAW AND VENUE

Proposer acknowledges and agrees that the contract is and shall be governed and construed by the laws of the State of Texas and that venue shall lie exclusively in a court of competent jurisdiction in Galveston County, Texas.

49. MERGERS, ACQUISITIONS

The Proposer shall be required to notify the County of any potential for merger or acquisition of which there is knowledge at the time that a Proposal is submitted.

If subsequent to the award of any contract resulting from this request for Proposal the Proposer shall merge or be acquired by another firm, the following documents must be submitted to the County:

- A. Corporate resolutions prepared by the awarded Proposer and the new entity ratifying acceptance of the original contract, terms, conditions and prices;
- B. New entity's Federal Identification Number (FEIN);
- C. New entity's proposed operating plans;
- D. New entity's proof of registration in SAM for contracts involving Federal funds;
- E. New entity's certification regarding debarment;
- F. New entity's certification regarding lobbying; and
- G. W-9 Form for new entity

Moreover, Proposer is required to provide the County with notice of any anticipated merger or acquisition as soon as Proposer has actual knowledge of the anticipated merger or acquisition. The New Proposer's proposed plan of operation must be submitted prior to merger to allow time for submission of such plan to the Commissioners' Court for its approval.

50. DELAYS

The County reserves the right to delay the scheduled commencement date of the contract if it is to the advantage of the County. There shall be no additional costs attributed to these delays should any occur. Proposer agrees it will make no claims for damages, for damages for lost revenues, for damages caused by breach of contract with third parties, or any other claim by Proposer attributed to these delays, should any occur. In addition, Proposer agrees that any contract it enters into with any third party in anticipation of the commencement of the contract will contain a statement that the third party will similarly make no claim for damages based on delay of the scheduled commencement date of the contract.

51. ACCURACY OF DATA

Information and data provided through this request for Proposal are believed to be reasonably accurate.

52. SUBCONTRACTING/ASSIGNMENT

Proposer shall not assign, sell, or otherwise transfer its contract in whole or in part without prior written permission of the County acting by and through its Commissioners' Court. Such consent, if granted, shall not relieve the Proposer of any of its responsibilities under this contract.

GENERAL PROVISIONS

REQUEST FOR PROPOSAL SEPTIC TANK SERVICES – RUNGE PARK GALVESTON COUNTY, TEXAS

53. INDEPENDENT CONTRACTOR

Proposer expressly acknowledges that it is an independent contractor. Nothing in this agreement is intended nor shall be construed to create an agency relationship, an employer/employee relationship, a joint venture relationship, or any other relationship allowing County to exercise control or direction over the manner or method by which Proposer or Proposer's subcontractors perform in providing the requirements stated in the request for Proposal.

54. MONITORING PERFORMANCE

The County shall have the unfettered right to monitor and audit the Proposer's work in every respect. In this regard, the Proposer shall provide its full cooperation and ensure the cooperation of its employees, agents, assigns, and subcontractors. Further, the Proposer shall make available for inspection and/or copying when requested, original data, records, and accounts relating to the Proposer's work and performance under this contract. In the event any such material is not held by the Proposer in its original form, a true copy shall be provided.

55. SUBJECT TO APPROPRIATION OF FUNDS

State law prohibits the obligation and expenditure of public funds beyond the fiscal year for which a budget has been approved by the Commissioners' Court. Galveston County anticipates this to be an integral part of future budgets to be approved during the periods of this contract, except for unanticipated needs or events which may prevent such payments against this contract. However, Galveston County cannot guarantee the availability of funds, and enters into this contract only to the extent such funds are made available through appropriation (allocation) by the Commissioners' Court. This contract shall not be construed as creating any debt on behalf of the County of Galveston in violation of TEX. CONST. art. XI, § 7, and it is understood that all obligations of Galveston County are subject to the availability of funds.

56. CONTRACTS SUBJECT TO GRANT FUNDING

Notwithstanding the foregoing, if the contract to be awarded by this procurement is funded with Federal or State grant funds, the Proposer acknowledges that the obligations of the County under the contract are contingent upon the continued availability of grant funding to meet the County's obligations. If the grant(s) to the County is reduced, de-obligated, or otherwise discontinued or terminated, Contractor agrees that the County may immediately terminate the contract without penalty or any liability whatsoever on the part of the County, the State, or the Federal awarding agency.

57. PROCUREMENT ETHICS

Galveston County is committed to the highest ethical standards. Therefore, it is a serious breach of the public trust to subvert the public purchasing process by directing purchases to certain favored vendors, or to tamper with the competitive Proposal process, whether it's done for kickbacks, friendship or any other reason. Since misuse of the purchasing power of a local government carries criminal penalties, and many such misuses are from a lack of clear guidelines about what constitutes an abuse of office, the Code of Ethics outlined below must be strictly followed.

Galveston County also requires ethical conduct from those who do business with the County.

GENERAL PROVISIONS

REQUEST FOR PROPOSAL SEPTIC TANK SERVICES – RUNGE PARK GALVESTON COUNTY, TEXAS

CODE OF ETHICS – Statement of Purchasing Policy:

Public employment is a public trust. It is the policy of Galveston County to promote and balance the objective of protecting the County's integrity and the objective of facilitating the recruitment and retention of personnel needed by Galveston County. Such policy is implemented by prescribing essential standards of ethical conduct without creating unnecessary obstacles to entering public office.

Public employees must discharge their duties impartially so as to assure fair competitive access to governmental procurement by responsible contractors. Moreover, they should conduct themselves in such a manner as to foster public confidence in the integrity of the Galveston County procurement organization. To achieve the purpose of this Article, it is essential that those doing business with Galveston County also observe the ethical standards prescribed herein.

General Ethical Standards:

It shall be a breach of ethics to attempt to realize personal gain through public employment with Galveston County by any conduct inconsistent with the proper discharge of the employee's duties.

It shall be a breach of ethics to attempt to influence any public employee of Galveston County to breach the standards of ethical conduct set forth in this code.

It shall be a breach of ethics for any employee of Galveston County to participate directly or indirectly in a procurement when the employee knows that:

- The employee or any member of the employee's family, has a financial interest pertaining to the procurement;
- A business or organization in which the employee or any member of the employee's family, has a financial interest pertaining to the procurement; or
- Any other person, business, or organization with which the employee or any member of the employee's family is negotiating or has an arrangement concerning prospective employment is involved in the procurement.

Gratuities:

It shall be a breach of ethics for any person to offer, give, or agree to give any employee or former employee of Galveston County, or for any employee or former employee of Galveston County to solicit, demand, accept or agree to accept from another person, a gratuity or an offer of employment in connection with any decision, approval, disapproval, recommendation, preparation of any part of a program requirement or a purchase request, influencing the content of any specification or procurement standard, rendering of advice, investigation, auditing, or in any other advisory capacity in any proceeding or application, request for ruling, determination, claim or controversy, or other particular matter, pertaining to any program requirement or a contract or subcontract, or to any solicitation or Proposal pending before this government.

Kickbacks:

It shall be a breach of ethics for any payment, gratuity or offer of employment to be made by or on behalf of a subcontractor under a contract to the prime contractor or higher tier subcontractor for any contract for Galveston County, or to any person associated therewith, as an inducement for the award of a contract, subcontract or order.

GENERAL PROVISIONS

REQUEST FOR PROPOSAL SEPTIC TANK SERVICES – RUNGE PARK GALVESTON COUNTY, TEXAS

Contract Clause:

The prohibition against gratuities and kickbacks prescribed above shall be conspicuously set forth in every contract and solicitation by Galveston County.

Confidential Information:

It shall be a breach of ethics for any employee or former employee of Galveston County to knowingly use confidential information for actual or anticipated personal gain, or for the actual or anticipated gain of any other person.

Prohibition against Contingent Fees:

It shall be a breach of ethical standards for a person to be retained, or to retain a person, to solicit or secure a Galveston County contract upon an agreement or understanding for a commission, percentage, brokerage, or contingent fee, except for retention of bona fide employees or bona fide established commercial selling agencies for the purpose of securing business. Failure to abide by this section constitutes a breach of ethical standards.

Representation:

Proposer represents and warrants, by signing and submitting its Proposal, that it has not retained anyone in violation of this section prohibiting contingent fees.

Contract Clause:

The representation prescribed above shall be conspicuously set forth in every contract and solicitation thereof.

58. NON-COLLUSION AFFIDAVIT

Proposer certifies, by signing and submitting a Proposal, that the Proposal is not made in the interest of, or on behalf of, any undisclosed person, partnership, company, association, organization, or corporation; that the Proposal is genuine and not collusive or sham; that the contractor has not directly or indirectly induced or solicited another contractor to put in a false or sham Proposal, and has not directly or indirectly colluded, conspired, connived, or agreed with any contractor or anyone else to put in a sham Proposal or that anyone shall refrain from proposing; that the contractor has not in any manner, directly or indirectly, sought by agreement, communications, or conference with anyone to fix the Proposal price of the contractor or any other Proposer, or to fix any overhead, profit or cost element of the Proposal price, or that of any other contractor, or to secure any advantage against the public body awarding the contract or anyone interested in the proposed contract; that all statements contained in the Proposal are true; and further, that the contractor has not, directly or indirectly, submitted his or her Proposal price or any breakdown thereof, or the contents thereof, or divulged information or data relative thereto, or paid, and will not pay, any fee to any cooperation, partnership, company association, organization, Proposal depository, or to any member or agent thereof to effectuate a collusive or sham Proposal.

A blank Non-Collusion Affidavit is included with this Proposal packet. Proposer must enclose a truthful and fully executed original Non-Collusion Affidavit with the submission of its Proposal. This is a mandatory requirement of this request for Proposal. Failure to include the truthfully and fully executed Non-Collusion Affidavit in the submission of its Proposal shall be considered non-compliance with the requirements of this request for Proposal by the Proposer and grounds for the rejection of Proposer's submission.

GENERAL PROVISIONS

REQUEST FOR PROPOSAL SEPTIC TANK SERVICES – RUNGE PARK GALVESTON COUNTY, TEXAS

No negotiations, decisions, or actions shall be initiated by any company as a result of any verbal discussion with any County employee prior to the opening of responses to this request for Proposal.

No officer or employee of the County of Galveston, and no other public or elected official, or employee, who may exercise any function or responsibilities in the review or approval of this undertaking shall have any personal or financial interest, direct or indirect, in any contract or negotiation process thereof. The above compliance request will be part of all County of Galveston contracts for this service.

59. CERTIFICATION REGARDING LOBBYING – COMPLIANT WITH APPENDIX A TO 24 C.F.R. PART 871

Proposer certifies that, to the best of his or her knowledge and belief, that:

- a. No Federal appropriated funds have been paid or will be paid, by or on behalf of the Proposer, to any person for influencing or attempting to influence a department or employee of an agency, a member of Congress, or an employee of a member of Congress in connection with the awarding of any Federal contract, the making of any Federal grant, the making of any Federal loan, the entering into of any cooperative agreement, and the extension, continuation, renewal, amendment, or modification of any Federal contract, grant, loan or cooperative agreement.
- b. If any funds other than federal appropriated funds have been paid or will be paid to any person for influencing or attempting to influence a department or employee of any agency, a member of Congress, a department or employee of congress, or an employee of a member of Congress in connection with this federal contract, grant, loan, or cooperative agreement, **the Proposer shall complete and submit Standard Form LLL, “Disclosure Form to Report Lobbying”, in accordance with its instructions.**
- c. Proposer shall require that the language of this certification be included in the award documents for all sub-awards at all tiers (including subcontracts, sub-grants, and contracts under grants, loans, and cooperative agreements) and that all sub-recipients shall certify and disclose accordingly.

This certification is a material representation of fact upon which reliance was placed when this transaction was made or entered into. Submission of the certification is a prerequisite for making or entering into a contract with Proposer and is imposed by Section 1352, Title 31, United States Code. Further, any person who fails to file the required certification shall be subject to a civil penalty of not less than \$10,000 and not more than \$100,000 for each such failure.

The truthful and fully completed and executed original of the Certification Regarding Lobbying (included with Proposal packet) must be included with the submission of Proposer’s Proposal and is a mandatory requirement of this request for Proposal. Proposer’s failure to include the fully completed and executed or original of this Certification shall be considered non-compliant with the requirements of this request for Proposal and grounds for the rejection of the Proposer’s Proposal.

60. NON-DISCRIMINATION

- a. **Equal Employment Opportunity:** Proposer will not discriminate against any employee or applicant for employment because of race, color, religion, national origin, sex, disability, genetic information or veteran status. Proposer will take affirmative action to ensure that applicants are employed, and that employees are treated during employment, without regard to their race, color, religion, national origin, sex, disability,

GENERAL PROVISIONS

REQUEST FOR PROPOSAL SEPTIC TANK SERVICES – RUNGE PARK GALVESTON COUNTY, TEXAS

genetic information or veteran status. Such action shall include, but not be limited to, the following: employment; upgrading; demotion or transfer; recruitment or recruitment advertising; layoff or termination; rates of pay or other forms of compensation; and selection for training, including apprenticeship. Proposer agrees to post in conspicuous places, available to employees and applicants for employment, notices of employment.

Proposer will, in all solicitation or advertisements for employees placed by or on behalf of Proposer, state that all qualified applicants will receive consideration for employment without regard to race, color, religion, national origin, sex, disability, genetic information, or veteran status. Proposer will cause the foregoing provisions to be inserted in all subcontracts for any work covered by this Agreement so that such provisions will be binding upon each subcontractor, provided that the foregoing provisions shall not apply to contracts or subcontracts for standard commercial supplies or raw materials.

Proposer will include the provisions herein in every subcontract or purchase order unless exempted.

- b. Drug Free Work Place Act: Proposer shall comply with all applicable requirements of the Drug-Free Workplace Act of 1988 (Public Law 100-690, Title V, Subtitle D; 41 U.S.C. § 8102, et seq.) and implementing regulations thereunder.
- c. Americans with Disabilities Act: Proposer shall comply with all applicable provisions of the Americans with Disabilities Act of 1990 (Public Law 101-136) and implementing regulations thereunder.
- d. OSHA Regulations: Proposer agrees to maintain and to display any applicable materials for its employees in accordance with OSHA regulations.
- e. Compliance with Immigration Laws and Use of E-Verify: Proposer agrees to comply with all requirements of the U.S. Immigration Reform and Control Act of 1986, as amended, and any implementing regulations thereto. Proposer further agrees to utilize the E-Verify system through the Department of Homeland Security on its employees. Proposer shall not employ unauthorized aliens and shall not assign services to be performed to any supplier or subcontractor who are unauthorized aliens. If any personnel performing any services hereunder are discovered to be an unauthorized alien, then Proposer will immediately remove such personnel from performing services hereunder and shall replace such personnel with personnel who are not unauthorized alien(s).
- f. State and Federal Law Compliance: Proposer agrees to comply with all other State and Federal laws and regulations applicable to the provision of services under this contract.
- g. The Contractor shall comply with the Age Discrimination Act of 1975 which provides that no person in the United States shall on the basis of age be excluded from participation in, be denied the benefits of, or be subjected to discrimination under any program or activity receiving federal financial assistance.

61. RECORD RETENTION AND RIGHT TO AUDIT

Proposer shall keep and maintain all records associated with this contract for a minimum of five (5) years from the close of the contract or as required by Federal or State law or regulation, whichever period is longer. If awarded this contract, Proposer shall allow the County reasonable access to the records in Proposer's possession, custody, or control that the County deems necessary to assist it in auditing the services, costs, and payments provided hereunder. If this contract involves the use of Federal or State funds, then Proposer shall also allow reasonable access to representatives of the Office of Inspector

GENERAL PROVISIONS

REQUEST FOR PROPOSAL SEPTIC TANK SERVICES – RUNGE PARK GALVESTON COUNTY, TEXAS

General, the General Accounting Office, the State Auditor's Office, and the other Federal and/or State agencies overseeing the funds that such entities deem necessary to facilitate review by such agencies and Proposer shall maintain fiscal records and supporting documentation for all expenditures in a manner that conforms with OMB Circular A-87 (relocated to 2 C.F.R. Part 225) and this contract.

62. TITLE VI ASSURANCES/TxDOT

The County is subject to Title VI of the Civil Rights Act of 1964 and the Federal and State laws and regulations of the United States Department of Transportation and Texas Department of Transportation (TxDOT). Pursuant to these requirements, the County must have its contractors provide required assurances on compliance with non-discrimination by itself and its subcontractors. The Title VI Assurances within this Subsection are not exhaustive – whenever any Federal, State, or Local requirement requires additional clauses, this list shall not be construed as limiting. Contractor agrees as follows:

- (1) **Compliance with Regulations:** The Contractor shall comply with the Regulations relative to nondiscrimination in Federally assisted programs of the Department of Transportation (hereinafter, DOT) Title 49, Code of Federal Regulations, Part 21, as they may be amended from time to time (hereinafter referred to as the Regulations), which are incorporated herein by reference and made a part of this contract.
- (2) **Non-discrimination:** The Contractor, with regard to the work performed by it during the contract, shall not discriminate on the basis of race, color, national origin, religion, sex, age, disability or Veteran status in the selection and retention of subcontractors, including procurements of materials and leases of equipment. The Contractor shall not participate either directly or indirectly in the discrimination prohibited by Section 21.5 of the Regulations, including employment practices when the contract covers a program set forth in Appendix B of the Regulations.
- (3) **Solicitations for Subcontractors, Including Procurement of Materials and Equipment:** In all solicitations either by competitive bidding or negotiation made by the Contractor for work to be performed under a subcontract, including procurement of materials or leases of equipment, each potential subcontractor or supplier shall be notified by the Contractor of the Contractor's obligations under this contract and the Regulations relative to nondiscrimination on the grounds of race, color, national origin, religion, sex, age, disability or Veteran status.
- (4) **Information and Reports:** The Contractor shall provide all information and reports required by the Regulations or directives issued pursuant thereto, and shall permit access to its books, records, accounts, other sources of information and its facilities as may be determined by the Galveston County or the Texas Department of Transportation to be pertinent to ascertain compliance with such Regulations, orders and instructions. Where any information required of the Contractor is in the exclusive possession of another who fails or refuses to furnish this information the Contractor shall so certify to Galveston County or the Texas Department of Transportation as appropriate and shall set forth what efforts it has made to obtain the information.
- (5) **Sanctions for Non-compliance:** In the event of the Contractor's noncompliance with the nondiscrimination provisions of this contract, Galveston County shall impose such contract sanctions as it or the Texas Department of Transportation may determine to be appropriate, including, but not limited to:

GENERAL PROVISIONS

REQUEST FOR PROPOSAL SEPTIC TANK SERVICES – RUNGE PARK GALVESTON COUNTY, TEXAS

- (a) withholding of payments to the Contractor under the contract until the Contractor complies, and/or;
 - (b) cancellation, termination, or suspension of the contract, in whole or in part.
- (6) **Incorporation of Provisions.** The Contractor shall include the provisions of paragraphs (1) through (6) in every subcontract, including procurement of materials and leases of equipment, unless exempt by the Regulations, or directives issued pursuant thereto. The Contractor shall take such action with respect to any subcontract or procurement as Galveston County or the Texas Department of Transportation may direct as a means of enforcing such provisions including sanctions for non-compliance: Provided, however, that, in the event Contractor becomes involved in, or is threatened with, litigation with a subcontractor or supplier as a result of such direction, the Contractor may request Galveston County to enter into such litigation to protect the interests of Galveston County, and, in addition, the Contractor may request the United States to enter into such litigation to protect the interests of the United States.
- 63. ASSURANCES FOR CONSTRUCTION PROGRAMS - TEXAS GENERAL LAND OFFICE (GLO)**
The County is subject to Federal and State laws and regulations of the United States and The Texas General Land Office (GLO). Pursuant to these requirements, the County must have its contractors provide required assurances on compliance with non-discrimination by itself and its subcontractors. These Assurances within this Subsection are not exhaustive – whenever any Federal, State, or Local requirement requires additional clauses, this list shall not be construed as limiting. Contractor agrees as follows:
- (1) Will comply with the Intergovernmental Personnel Act of 1970 (42 U.S.C. §§4728-4763) relating to prescribed standards for merit systems for programs funded under one of the 19 statutes or regulations specified in Appendix A of OPM’s Standards for a Merit System of Personnel Administration (5 C.F.R. 900, Subpart F).
 - (2) Will comply with the Lead-Based Paint Poisoning Prevention Act (42 U.S.C. §§4801 et seq.) which prohibits the use of lead-based paint in construction or rehabilitation of residence structures.
 - (3) Will comply with all Federal statutes relating to non-discrimination. These include but are not limited to: (a) Title VI of the Civil Rights Act of 1964 (P.L. 88-352) which prohibits discrimination on the basis of race, color or national origin; (b) Title IX of the Education Amendments of 1972, as amended (20 U.S.C. §§1681-1683, and 1685-1686), which prohibits discrimination on the basis of sex; (c) Section 504 of the Rehabilitation Act of 1973, as amended (29 U.S.C. §794), which prohibits discrimination on the basis of handicaps; (d) the Age Discrimination Act of 1975, as amended (42 U.S.C. §§6101-6107), which prohibits discrimination on the basis of age; (e) the Drug Abuse Office and Treatment Act of 1972 (P.L. 92-255), as amended, relating to nondiscrimination on the basis of drug abuse; (f) the Comprehensive Alcohol Abuse and Alcoholism Prevention, Treatment and Rehabilitation Act of 1970 (P.L. 91-616), as amended, relating to nondiscrimination on the basis of alcohol abuse or alcoholism; (g) §§523 and 527 of the Public Health Service Act of 1912 (42 U.S.C. §§290 dd-3 and 290 ee-3), as amended, relating to confidentiality of

GENERAL PROVISIONS

REQUEST FOR PROPOSAL SEPTIC TANK SERVICES – RUNGE PARK GALVESTON COUNTY, TEXAS

alcohol and drug abuse patient records; (h) Title VIII of the Civil Rights Act of 1968 (42 U.S.C. §§3601 et seq.), as amended, relating to nondiscrimination in the sale, rental or financing of housing; (i) any other non-discrimination provisions in the specific statute(s) under which application for Federal assistance is being made; and (j) the requirements of any other nondiscrimination statute(s) which may apply to the application.

- (4) Will comply with the Intergovernmental Personnel Act of 1970 (42 U.S.C. §§4728-4763) relating to prescribed standards for merit systems for programs funded under one of the 19 statutes or regulations specified in Appendix A of OPM's Standards for a Merit System of Personnel Administration (5 C.F.R. 900, Subpart F).
- (5) Will comply with the Lead-Based Paint Poisoning Prevention Act (42 U.S.C. §§4801 et seq.) which prohibits the use of lead-based paint in construction or rehabilitation of residence structures.
- (6) Will comply with all Federal statutes relating to non-discrimination. These include but are not limited to: (a) Title VI of the Civil Rights Act of 1964 (P.L. 88-352) which prohibits discrimination on the basis of race, color or national origin; (b) Title IX of the Education Amendments of 1972, as amended (20 U.S.C. §§1681-1683, and 1685-1686), which prohibits discrimination on the basis of sex; (c) Section 504 of the Rehabilitation Act of 1973, as amended (29 U.S.C. §794), which prohibits discrimination on the basis of handicaps; (d) the Age Discrimination Act of 1975, as amended (42 U.S.C. §§6101-6107), which prohibits discrimination on the basis of age; (e) the Drug Abuse Office and Treatment Act of 1972 (P.L. 92-255), as amended, relating to nondiscrimination on the basis of drug abuse; (f) the Comprehensive Alcohol Abuse and Alcoholism Prevention, Treatment and Rehabilitation Act of 1970 (P.L. 91-616), as amended, relating to nondiscrimination on the basis of alcohol abuse or alcoholism; (g) §§523 and 527 of the Public Health Service Act of 1912 (42 U.S.C. §§290 dd-3 and 290 ee-3), as amended, relating to confidentiality of alcohol and drug abuse patient records; (h) Title VIII of the Civil Rights Act of 1968 (42 U.S.C. §§3601 et seq.), as amended, relating to nondiscrimination in the sale, rental or financing of housing; (i) any other non-discrimination provisions in the specific statute(s) under which application for Federal assistance is being made; and (j) the requirements of any other nondiscrimination statute(s) which may apply to the application.
- (7) Will comply, or has already complied, with the requirements of Titles II and III of the Uniform Relocation Assistance and Real Property Acquisition Policies Act of 1970 (P.L. 91-646) which provide for fair and equitable treatment of persons displaced or whose property is acquired as a result of Federal and federally assisted programs. These requirements apply to all interests in real property acquired for project purposes regardless of Federal participation in purchases.
- (8) Will comply with the provisions of the Hatch Act (5 U.S.C. §§1501-1508 and 7324-7328) which limit the political activities of employees whose principal employment activities are funded in whole or in part with Federal funds.

GENERAL PROVISIONS

REQUEST FOR PROPOSAL SEPTIC TANK SERVICES – RUNGE PARK GALVESTON COUNTY, TEXAS

- (9) Will comply, as applicable, with the provisions of the Davis- Bacon Act (40 U.S.C. §§276a to 276a-7), the Copeland Act (40 U.S.C. §276c and 18 U.S.C. §874), and the Contract Work Hours and Safety Standards Act (40 U.S.C. §§327-333) regarding labor standards for federally assisted construction sub agreements.
- (10) Will comply with flood insurance purchase requirements of Section 102(a) of the Flood Disaster Protection Act of 1973 (P.L. 93-234) which requires recipients in a special flood hazard area to participate in the program and to purchase flood insurance if the total cost of insurable construction and acquisition is \$10,000 or more.
- (11) Will comply with environmental standards which may be prescribed pursuant to the following: (a) institution of environmental quality control measures under the National Environmental Policy Act of 1969 (P.L. 91-190) and Executive Order (EO) 11514; (b) notification of violating facilities pursuant to EO 11738; (c) protection of wetlands pursuant to EO 11990; (d) evaluation of flood hazards in floodplains in accordance with EO 11988; (e) assurance of project consistency with the approved State management program developed under the Coastal Zone Management Act of 1972 (16 U.S.C. §§1451 et seq.); (f) conformity of Federal actions to State (Clean Air) Implementation Plans under Section 176(c) of the Clean Air Act of 1955, as amended (42 U.S.C. §§7401 et seq.); (g) protection of underground sources of drinking water under the Safe Drinking Water Act of 1974, as amended (P.L. 93-523); and, (h) protection of endangered species under the Endangered Species Act of 1973, as amended (P.L. 93205).
- (12) Will comply with the Wild and Scenic Rivers Act of 1968 (16 U.S.C. §§1271 et seq.) related to protecting components or potential components of the national wild and scenic rivers system.
- (13) Will assist the awarding agency in assuring compliance with Section 106 of the National Historic Preservation Act of 1966, as amended (16 U.S.C. §470), EO 11593 (identification and protection of historic properties), and the Archaeological and Historic Preservation Act of 1974 (16 U.S.C. §§469a-1 et seq.).
- (14) Will cause to be performed the required financial and compliance audits in accordance with the Single Audit Act Amendments of 1996 and OMB Circular No. A-133, "Audits of States, Local Governments, and Non-Profit Organizations."
- (15) Will comply with all applicable requirements of all other Federal laws, executive orders, regulations, and policies governing this program.
- (16) Will comply with the requirements of Section 106(g) of the Trafficking Victims Protection Act (TVPA) of 2000, as amended (22 U.S.C. 7104) which prohibits grant award recipients or a sub-recipient from (1) Engaging in severe forms of trafficking in persons during the period of time that the award is in effect (2) Procuring a commercial sex act during the period of time that the award is in effect or (3) Using forced labor in the performance of the award or subawards under the award.

GENERAL PROVISIONS

REQUEST FOR PROPOSAL SEPTIC TANK SERVICES – RUNGE PARK GALVESTON COUNTY, TEXAS

64. GENERAL AFFIRMATIONS – TEXAS GENERAL LAND OFFICE (GLO)

To the extent they apply, affirms, and agrees to the following, without exception:

1. represents and warrants that, in accordance with Section 2155.005 of the Texas Government Code, neither nor the firm, corporation, partnership, or institution represented by , or anyone acting for such a firm, corporation, partnership, or institution has (1) violated any provision of the Texas Free Enterprise and Antitrust Act of 1983, Chapter 15 of the Texas Business and Commerce Code, or the federal antitrust laws, or (2) communicated directly or indirectly the contents of this Contract or any solicitation response upon which this Contract is based to any competitor or any other person engaged in the same line of business as .
2. If the Contract is for services, shall comply with Section 2155.4441 of the Texas Government Code, requiring the purchase of products and materials produced in the State of Texas in performing service contracts.
3. Under Section 231.006 of the Family Code, the vendor or applicant certifies that the individual or business entity named in this Contract, bid or application is not ineligible to receive the specified grant, loan, or payment and acknowledges that this Contract may be terminated and payment may be withheld if this certification is inaccurate.
4. A bid or an application for a contract, grant, or loan paid from state funds must include the name and social security number of the individual or sole proprietor and each partner, shareholder, or owner with an ownership interest of at least 25 percent of the business entity submitting the bid or application. certifies it has submitted this information to the GLO.
5. If the Contract is for the purchase or lease of computer equipment, as defined by Texas Health and Safety Code Section 361.952(2), certifies that it is in compliance with Subchapter Y, Chapter 361 of the Texas Health and Safety Code, related to the Computer Equipment Recycling Program and the Texas Commission on Environmental Quality rules in Title 30 Texas Administrative Code Chapter 328.
6. Pursuant to Section 2155.003 of the Texas Government Code, represents and warrants that it has not given, offered to give, nor intends to give at any time hereafter any economic opportunity, future employment, gift, loan, gratuity, special discount, trip, favor, or service to a public servant in connection with the Contract.
7. Payments due under the Contract shall be directly applied towards eliminating any debt or delinquency owes to the State of Texas including, but not limited to, delinquent taxes, delinquent student loan payments, and delinquent child support.
8. Upon request of the GLO, shall provide copies of its most recent business continuity and disaster recovery plans.
9. If the Contract is for consulting services governed by Texas Government Code Chapter 2254, Subchapter B, in accordance with Section 2254.033 of the Texas Government Code, relating to consulting services, certifies that it does not employ an individual who has been employed by The GLO or another agency at any time during the two years preceding the 's submission of its offer to provide consulting services to the GLO or, in the alternative, , in its offer to provide consulting services to the GLO, disclosed the following: (i) the nature of the previous employment with the GLO or other state agency; (ii) the date

GENERAL PROVISIONS

REQUEST FOR PROPOSAL SEPTIC TANK SERVICES – RUNGE PARK GALVESTON COUNTY, TEXAS

the employment was terminated; and (iii) the annual rate of compensation for the employment at the time of its termination.

10. If the Contract is not for architecture, engineering, or construction services, except as otherwise provided by statute, rule, or regulation, must use the dispute resolution process provided for in Chapter 2260 of the Texas Government Code to attempt to resolve any dispute arising under the Contract. NOTHING IN THIS SECTION SHALL BE CONSTRUED AS A WAIVER OF SOVEREIGN IMMUNITY BY THE GLO.
11. If the Contract is for architecture, engineering, or construction services, subject to Texas Government Code, Section 2260.002 and Texas Civil Practice and Remedies Code Chapter 114, and except as otherwise provided by statute, rule, or regulation, shall use the dispute resolution process provided for in Chapter 2260 of the Texas Government Code to attempt to resolve all disputes arising under this Contract. Except as otherwise provided by statute, rule, or regulation, in accordance with the Texas Civil Practice and Remedies Code, Section 114.005, claims encompassed by Texas Government Code, Section 2260.002(3) and Texas Civil Practice and Remedies Code Section 114.002 shall be governed by the dispute resolution process set forth below in subsections (a)-(d). NOTHING IN THIS SECTION SHALL BE CONSTRUED AS A WAIVER OF SOVEREIGN IMMUNITY BY THE GLO.
 - a. Notwithstanding Texas Government Code, Chapter 2260.002(3) and Chapter 114.012 and any other statute or applicable law, if the 's claim for breach of contract cannot be resolved by the parties in the ordinary course of business, may make a claim against the GLO for breach of contract and the GLO may assert a counterclaim against the as is contemplated by Texas Government Code, Chapter 2260, Subchapter B. In such event, must provide written notice to the GLO of a claim for breach of the Contract not later than the 180th day after the date of the event giving rise to the claim. The notice must state with particularity: (1) the nature of the alleged breach; (2) the amount the seeks as damages; and (3) the legal theory of recovery.
 - b. The chief administrative officer, or if designated in the Contract, another officer of the GLO, shall examine the claim and any counterclaim and negotiate with the in an effort to resolve them. The negotiation must begin no later than the 120th day after the date the claim is received, as is contemplated by Texas Government Code, Chapter 2260, Section 2260.052.
 - c. If the negotiation under paragraph (b) above results in the resolution of some disputed issues by agreement or in a settlement, the parties shall reduce the agreement or settlement to writing and each party shall sign the agreement or settlement. A partial settlement or resolution of a claim does not waive a party's rights under this Contract as to the parts of the claim that are not resolved.
 - d. If a claim is not entirely resolved under paragraph (b) above, on or before the 270th day after the date the claim is filed with the GLO, unless the parties agree in writing to an extension of time, the parties may agree to mediate a claim made under this dispute resolution procedure. This dispute resolution procedure is the 's sole and exclusive process for seeking a remedy for an alleged breach of contract by the GLO if the parties are unable to resolve their disputes as described in this section.
 - e. Nothing in the Contract shall be construed as a waiver of the state's or the GLO's sovereign immunity. This Contract shall not constitute or be construed as a waiver of any of the privileges, rights, defenses, remedies, or immunities available to the State of Texas. The failure to enforce, or any delay in the enforcement, of any privileges, rights, defenses, remedies, or immunities available

GENERAL PROVISIONS

REQUEST FOR PROPOSAL SEPTIC TANK SERVICES – RUNGE PARK GALVESTON COUNTY, TEXAS

to the State of Texas under this Contract or under applicable law shall not constitute a waiver of such privileges, rights, defenses, remedies or immunities or be considered as a basis for estoppel. The GLO does not waive any privileges, rights, defenses, or immunities available to it by entering into this Contract or by its conduct, or by the conduct of any representative of the GLO, prior to or subsequent to entering into this Contract.

- f. Except as otherwise provided by statute, rule, or regulation, compliance with the dispute resolution process provided for in Texas Government Code, Chapter 2260, subchapter B and incorporated by reference in subsection (a)-(d) above is a condition precedent to the: (1) filing suit pursuant to Chapter 114 of the Civil Practices and Remedies Code; or (2) initiating a contested case hearing pursuant to Subchapter C of Chapter 2260 of the Texas Government Code.
12. If Texas Government Code Chapter 2270 prohibiting state contracts with companies boycotting Israel applies to and this Contract, then verifies it does not boycott Israel and will not boycott Israel during the term of this Contract.
13. This Contract is contingent upon the continued availability of lawful appropriations by the Texas Legislature. understands that all obligations of the GLO under this Contract are subject to the availability of state funds. If such funds are not appropriated or become unavailable, the GLO may terminate the Contract. The Contract shall not be construed as creating a debt on behalf of the GLO in violation of Article III, Section 49a of the Texas Constitution.
14. certifies that it is not listed on the federal government's terrorism watch list as described in Executive Order 13224.
15. In accordance with Section 669.003 of the Texas Government Code, relating to contracting with the executive head of a state agency, certifies that it is not (1) the executive head of the GLO, (2) a person who at any time during the four years before the effective date of the Contract was the executive head of the GLO, or (3) a person who employs a current or former executive head of the GLO.
16. represents and warrants that all statements and information prepared and submitted in connection with this Contract are current, complete, true, and accurate. Submitting a false statement or making a material misrepresentation during the performance of this Contract is a material breach of contract and may void the Contract or be grounds for its termination.
17. Pursuant to Section 2155.004(a) of the Texas Government Code, certifies that neither nor any person or entity represented by has received compensation from the GLO to participate in the preparation of the specifications or solicitation on which this Contract is based. Under Section 2155.004(b) of the Texas Government Code, certifies that the individual or business entity named in this Contract is not ineligible to receive the specified contract and acknowledges that the Contract may be terminated and payment withheld if this certification is inaccurate. This Section does not prohibit from providing free technical assistance.
18. represents and warrants that it is not engaged in business with Iran, Sudan, or a foreign terrorist organization, as prohibited by Section 2252.152 of the Texas Government Code.
19. If the Contract is for professional or consulting services governed by Texas Government Code Chapter 2254, represents and warrants that none of its employees including, but not limited to, those authorized

GENERAL PROVISIONS

REQUEST FOR PROPOSAL SEPTIC TANK SERVICES – RUNGE PARK GALVESTON COUNTY, TEXAS

to provide services under the Contract, were former employees of the GLO during the twelve (12) month period immediately prior to the date of execution of the Contract.

20. The Contract shall be governed by and construed in accordance with the laws of the State of Texas, without regard to the conflicts of law provisions. The venue of any suit arising under the Contract is fixed in any court of competent jurisdiction of Travis County, Texas, unless the specific venue is otherwise identified in a statute which directly names or otherwise identifies its applicability to the GLO.
21. IF THE CONTRACT IS NOT FOR ARCHITECTURE OR ENGINEERING SERVICES GOVERNED BY TEXAS GOVERNMENT CODE CHAPTER 2254, , TO THE EXTENT ALLOWED BY LAW, SHALL DEFEND, INDEMNIFY AND HOLD HARMLESS THE STATE OF TEXAS AND THE GLO, AND/OR THEIR OFFICERS, AGENTS, EMPLOYEES, REPRESENTATIVES, CONTRACTORS, ASSIGNEES, AND/OR DESIGNEES FROM ANY AND ALL LIABILITY, ACTIONS, CLAIMS, DEMANDS, OR SUITS, AND ALL RELATED COSTS, ATTORNEY FEES, AND EXPENSES ARISING OUT OF, OR RESULTING FROM ANY ACTS OR OMISSIONS OF OR ITS AGENTS, EMPLOYEES, SUBCONTRACTORS, ORDER FULFILLERS, OR SUPPLIERS OF SUBCONTRACTORS IN THE EXECUTION OR PERFORMANCE OF THE CONTRACT AND ANY PURCHASE ORDERS ISSUED UNDER THE CONTRACT. THE DEFENSE SHALL BE COORDINATED BY WITH THE OFFICE OF THE TEXAS ATTORNEY GENERAL WHEN TEXAS STATE AGENCIES ARE NAMED DEFENDANTS IN ANY LAWSUIT AND MAY NOT AGREE TO ANY SETTLEMENT WITHOUT FIRST OBTAINING THE CONCURRENCE FROM THE OFFICE OF THE TEXAS ATTORNEY GENERAL. AND THE GLO SHALL FURNISH TIMELY WRITTEN NOTICE TO EACH OTHER OF ANY SUCH CLAIM.
22. IF THE CONTRACT IS FOR ARCHITECTURE OR ENGINEERING SERVICES GOVERNED BY TEXAS GOVERNMENT CODE CHAPTER 2254, , TO THE EXTENT ALLOWED BY LAW, SHALL INDEMNIFY AND HOLD HARMLESS THE STATE OF TEXAS AND THE GLO, AND/OR THEIR OFFICERS, AGENTS, EMPLOYEES, REPRESENTATIVES, CONTRACTORS, ASSIGNEES, AND/OR DESIGNEES FROM ANY AND ALL LIABILITY, ACTIONS, CLAIMS, DEMANDS, OR SUITS, AND ALL RELATED DAMAGES, COSTS, ATTORNEY FEES, AND EXPENSES TO THE EXTENT CAUSED BY, ARISING OUT OF, OR RESULTING FROM ANY ACTS OF NEGLIGENCE, INTENTIONAL TORTS, WILLFUL MISCONDUCT, PERSONAL INJURY OR DAMAGE TO PROPERTY, AND/OR OTHERWISE RELATED TO 'S PERFORMANCE, AND/OR FAILURES TO PAY A SUBCONTRACTOR OR SUPPLIER BY THE OR ITS AGENTS, EMPLOYEES, SUBCONTRACTORS, ORDER FULFILLERS, CONSULTANTS UNDER CONTRACT TO , OR ANY OTHER ENTITY OVER WHICH THE CONTRACTOR EXERCISES CONTROL, OR SUPPLIERS OF SUBCONTRACTORS IN THE EXECUTION OR PERFORMANCE OF THE CONTRACT. THE DEFENSE SHALL BE COORDINATED BY WITH THE OFFICE OF THE TEXAS ATTORNEY GENERAL WHEN TEXAS STATE AGENCIES ARE NAMED DEFENDANTS IN ANY LAWSUIT AND MAY NOT AGREE TO ANY SETTLEMENT WITHOUT FIRST OBTAINING THE CONCURRENCE FROM THE OFFICE OF THE TEXAS ATTORNEY GENERAL. AND THE GLO SHALL FURNISH TIMELY WRITTEN NOTICE TO EACH OTHER OF ANY SUCH CLAIM.
23. TO THE EXTENT ALLOWED BY LAW, SHALL DEFEND, INDEMNIFY, AND HOLD HARMLESS THE GLO AND THE STATE OF TEXAS FROM AND AGAINST ANY AND ALL CLAIMS, VIOLATIONS, MISAPPROPRIATIONS OR INFRINGEMENT OF ANY PATENT, TRADEMARK, COPYRIGHT, TRADE SECRET OR OTHER INTELLECTUAL PROPERTY

GENERAL PROVISIONS

REQUEST FOR PROPOSAL SEPTIC TANK SERVICES – RUNGE PARK GALVESTON COUNTY, TEXAS

RIGHTS AND/OR OTHER INTANGIBLE PROPERTY, PUBLICITY OR PRIVACY RIGHTS, AND/OR IN CONNECTION WITH OR ARISING FROM: (1) THE PERFORMANCE OR ACTIONS OF PURSUANT TO THIS CONTRACT; (2) ANY DELIVERABLE, WORK PRODUCT, CONFIGURED SERVICE OR OTHER SERVICE PROVIDED HEREUNDER; AND/OR (3) THE GLO'S AND/OR 'S USE OF OR ACQUISITION OF ANY REQUESTED SERVICES OR OTHER ITEMS PROVIDED TO THE GLO BY OR OTHERWISE TO WHICH THE GLO HAS ACCESS AS A RESULT OF 'S PERFORMANCE UNDER THE CONTRACT. AND THE GLO SHALL FURNISH TIMELY WRITTEN NOTICE TO EACH OTHER OF ANY SUCH CLAIM. SHALL BE LIABLE TO PAY ALL COSTS OF DEFENSE, INCLUDING ATTORNEYS' FEES. THE DEFENSE SHALL BE COORDINATED BY WITH THE OFFICE OF THE TEXAS ATTORNEY GENERAL (OAG) WHEN TEXAS STATE AGENCIES ARE NAMED DEFENDANTS IN ANY LAWSUIT AND MAY NOT AGREE TO ANY SETTLEMENT WITHOUT FIRST OBTAINING THE CONCURRENCE FROM OAG. IN ADDITION, WILL REIMBURSE THE GLO AND THE STATE OF TEXAS FOR ANY CLAIMS, DAMAGES, COSTS, EXPENSES OR OTHER AMOUNTS, INCLUDING, BUT NOT LIMITED TO, ATTORNEYS' FEES AND COURT COSTS, ARISING FROM ANY SUCH CLAIM. IF THE GLO DETERMINES THAT A CONFLICT EXISTS BETWEEN ITS INTERESTS AND THOSE OF OR IF THE GLO IS REQUIRED BY APPLICABLE LAW TO SELECT SEPARATE COUNSEL, THE GLO WILL BE PERMITTED TO SELECT SEPARATE COUNSEL AND WILL PAY ALL REASONABLE COSTS OF THE GLO'S COUNSEL.

24. has disclosed in writing to the GLO all existing or potential conflicts of interest relative to the performance of the Contract.
25. Sections 2155.006 and 2261.053 of the Texas Government Code prohibit state agencies from accepting a solicitation response or awarding a contract that includes proposed financial participation by a person who, in the past five years, has been convicted of violating a federal law or assessed a penalty in connection with a contract involving relief for Hurricane Rita, Hurricane Katrina, or any other disaster, as defined by Section 418.004 of the Texas Government Code, occurring after September 24, 2005. Under Sections 2155.006 and 2261.053 of the Texas Government Code, certifies that the individual or business entity named in this Contract is not ineligible to receive the specified contract and acknowledges that this Contract may be terminated and payment withheld if this certification is inaccurate.
26. understands that the GLO will comply with the Texas Public Information Act (Chapter 552 of the Texas Government Code) as interpreted by judicial rulings and opinions of the Attorney General of the State of Texas. Information, documentation, and other material related to this Contract may be subject to public disclosure pursuant to the Texas Public Information Act. In accordance with Section 2252.907 of the Texas Government Code, shall make any information created or exchanged with the State/GLO pursuant to the Contract, and not otherwise excepted from disclosure under the Texas Public Information Act, available in a format that is accessible by the public at no additional charge to the State or the GLO.
27. The person executing this Contract certifies that he/she is duly authorized to execute this Contract on his/her own behalf or on behalf of and legally empowered to contractually bind to the terms and conditions of the Contract and related documents.
28. If the Contract is for architectural or engineering services, pursuant to Section 2254.0031 of the Texas Government Code, which incorporates by reference Section 271.904(d) of the Texas Local Government Code, shall perform services (1) with professional skill and care ordinarily provided by competent engineers or architects practicing under the same or similar circumstances and professional license, and

GENERAL PROVISIONS

REQUEST FOR PROPOSAL SEPTIC TANK SERVICES – RUNGE PARK GALVESTON COUNTY, TEXAS

- (2) as expeditiously as is prudent considering the ordinary professional skill and care of a competent engineer or architect.
29. The state auditor may conduct an audit or investigation of any entity receiving funds from the state directly under the Contract or indirectly through a subcontract under the Contract. The acceptance of funds directly under the Contract or indirectly through a subcontract under the Contract acts as acceptance of the authority of the state auditor, under the direction of the legislative audit committee, to conduct an audit or investigation in connection with those funds. Under the direction of the legislative audit committee, an entity that is the subject of an audit or investigation by the state auditor must provide the state auditor with access to any information the state auditor considers relevant to the investigation or audit. shall ensure that this paragraph concerning the authority to audit funds received indirectly by subcontractors through the Contract and the requirement to cooperate is included in any subcontract it awards. The GLO may unilaterally amend the Contract to comply with any rules and procedures of the state auditor in the implementation and enforcement of Section 2262.154 of the Texas Government Code.
30. certifies that neither it nor its principals are debarred, suspended, proposed for debarment, declared ineligible, or otherwise excluded from participation in the Contract by any state or federal agency.
31. expressly acknowledges that state funds may not be expended in connection with the purchase of an automated information system unless that system meets certain statutory requirements relating to accessibility by persons with visual impairments. Accordingly, represents and warrants to the GLO that any technology provided to the GLO for purchase pursuant to this Contract is capable, either by virtue of features included within the technology or because it is readily adaptable by use with other technology, of: providing equivalent access for effective use by both visual and non-visual means; presenting information, including prompts used for interactive communications, in formats intended for non-visual use; and being integrated into networks for obtaining, retrieving, and disseminating information used by individuals who are not blind or visually impaired. For purposes of this Section, the phrase “equivalent access” means a substantially similar ability to communicate with or make use of the technology, either directly by features incorporated within the technology or by other reasonable means such as assistive devices or services which would constitute reasonable accommodations under the Americans With Disabilities Act or similar state or federal laws. Examples of methods by which equivalent access may be provided include, but are not limited to, keyboard alternatives to mouse commands and other means of navigating graphical displays, and customizable display appearance.
32. If the Contract is for the purchase or lease of covered television equipment, as defined by Section 361.971(3) of the Texas Health and Safety Code, certifies its compliance with Subchapter Z, Chapter 361 of the Texas Health and Safety Code, related to the Television Equipment Recycling Program.
33. Pursuant to Section 572.069 of the Texas Government Code, certifies it has not employed and will not employ a former state officer or employee who participated in a procurement or contract negotiations for the GLO involving within two (2) years after the date that the contract is signed or the procurement is terminated or withdrawn. This certification only applies to former state officers or employees whose state service or employment ceased on or after September 1, 2015.
34. The GLO does not tolerate any type of fraud. GLO policy promotes consistent, legal, and ethical organizational behavior by assigning responsibilities and providing guidelines to enforce controls. Any violations of law, agency policies, or standards of ethical conduct will be investigated, and appropriate

GENERAL PROVISIONS

REQUEST FOR PROPOSAL SEPTIC TANK SERVICES – RUNGE PARK GALVESTON COUNTY, TEXAS

actions will be taken. shall report any possible fraud, waste, or abuse that occurs in connection with the Contract to the GLO's Fraud Reporting hotline at (877) 888-0002.

35. The requirements of Subchapter J, Chapter 552, Government Code, may apply to this contract and agrees that the Contract can be terminated if knowingly or intentionally fails to comply with a requirement of that subchapter.
36. If, in its performance of the Contract, has access to a state computer system or database, must complete a cybersecurity training program certified under Texas Government Code Section 2054.519, as selected by the GLO. must complete the cybersecurity training program during the initial term of the Contract and during any renewal period. must verify in writing to the GLO its completion of the cybersecurity training program.
37. Under Section 2155.0061, Texas Government Code, certifies that the entity named in this contract is not ineligible to receive the specified contract and acknowledges that this contract may be terminated and payment withheld if this certification is inaccurate.

**REQUEST FOR PROPOSAL
SEPTIC TANK SERVICES – RUNGE PARK
GALVESTON COUNTY, TEXAS**

65. SECTION 231.006, FAMILY CODE/DELINQUENT CHILD SUPPORT

Pursuant to Title 5, Section 231.006 of the Texas Family Code, as applicable, Proposer certifies that it, including all of its principals, is/are current in child support payments and that it is eligible to receive payments from State funds under a contract for property, materials, or services. Proposer acknowledges and agrees that if it is awarded this contract, then the ensuing agreement may be terminated, and payment withheld if this certification is inaccurate. Finally, by the submission of its Proposal, the Proposer certifies that it has included the names and social security numbers of each person with at least 25% ownership interest in Proposer within its response to the request for Proposal and that all such persons are current in child support payments.

66. ANTITRUST

Pursuant to 15 U.S.C. § 1, et seq., and Texas Business and Commerce Code, Chapter 15, Contractor, by the submission of its Proposal, certifies that neither Contractor nor any natural person, proprietorship, firm, corporation, partnership, association, or institution represented by Contractor or anyone acting for such natural person, proprietorship, firm, corporation, partnership, association, or institution has violated any Federal or State antitrust laws or communicated the nature of the offer, directly or indirectly, to any competitor or other person engaged in a similar line of business.

67. LABOR STANDARDS

On contracts funded under a federal grant: Proposer acknowledges that the contract to be awarded pursuant to this solicitation is on a grant program funded with Federal funds. Proposer shall comply with the requirements of 29 CFR Part 5 and Part 30 and shall be in conformity with Executive Order 11246, entitled “Equal Employment Opportunity”, Copeland, “Anti-Kickback” Act (40 U.S.C. 3145, 29 C.F.R. Part 3), the Davis-Bacon and Related Acts (40 U.S.C. 3141-3148, 29 C.F.R. Parts 1,3, and 5), the Contract Work Hours and Safety Standards Act (40 U.S.C. 3701 et seq.), and all other applicable Federal, State, and local laws and regulations pertaining to labor standards, insofar as those acts apply to the performance of this Agreement. Proposer is also responsible for ensuring that all subcontractors comply with the requirements of 29 CFR Part 5 and Part 30 and shall be in conformity with Executive Order 11246, entitled “Equal Employment Opportunity”, Copeland “Anti-Kickback” Act, the Davis-Bacon and Related Acts (29 CFR Parts 1, 3 and 5), the Contract Work Hours and Safety Standards Act (40 U.S.C. 3701 et seq.), and all other applicable Federal, State, and local laws and regulations pertaining to labor standards, insofar as those acts apply to the performance of this Agreement.

Contractor is encouraged to use local labor, but not at the expense of poor workmanship and higher cost. Contractor will not discriminate against any employee or applicant for employment because of race, religion, color, sex, or national origin. Contractor agrees to post in a conspicuous place a notice setting forth provisions of this non-discrimination clause.

68. PROCUREMENT STANDARDS - 2 C.F.R. §§ 200.317 – 200.326 & 2 C.F.R. PART 200, APPENDIX II

The Office of Management and Budget (OMB) revised the Uniform Guidance for grants (2 C.F.R. part 200) on August 13, 2020. This was the first major updating of the Uniform Guidance since 2014.

Effective Date:

- The full suite of changes became effective November 12, 2020. They will apply to all new Grants to States awards issued after that date, including the FY2021 awards.

Procurement:

New provisions for procurements by States (2 C.F.R. § 200.317):

When procuring property and services under an award, a State will continue to follow the same policies and procedures it uses for procurement from its non-Federal funds. A State must now also comply with §§ 200.321

**REQUEST FOR PROPOSAL
SEPTIC TANK SERVICES – RUNGE PARK
GALVESTON COUNTY, TEXAS**

(contracting with small and minority businesses, women’s business enterprises, and labor surplus area firms) and 200.322 (domestic preferences for procurements); and continue to comply with § 200.323 (procurement of recovered materials).

New provisions for all other non-Federal entities, including subrecipients of a State:

The OMB explains in the Aug. 13, 2020, Federal Register notice for the Uniform Guidance revisions, the following changes were made to 2 C.F.R § 200.320 (methods of procurement):

- The procurement types are now grouped into three categories:
 - (1) Informal (micro-purchase, small purchase);
 - (2) Formal (sealed Proposals, proposals); and
 - (3) Non-Competitive (sole source).

The micro-purchase threshold is raised from \$3,500 to \$10,000. Micro-purchase thresholds higher than \$10,000 are based on certain conditions that include a requirement to maintain records for threshold up to \$50,000 and a formal approval process by the Fed. Govt. for threshold above \$50,000.

More specifically, for Grants to States:

- (1) the subrecipient may self-certify an increase of the micro-purchase threshold up to \$50,000 (based on certain requirements).
- (2) micro-purchase thresholds higher than \$50,000 must be approved by the cognizant agency for indirect costs. (for details, see 2 C.F.R § 200.320 (a) (1) (iii) and (iv)).

The simplified acquisition threshold is raised from \$150,000 to \$250,000.

Two contract clauses were added to Appendix II of 2 C.F.R. Part 200. In addition to the previous contract clauses contained in the 2014 version of Appendix II of 2 C.F.R. Part 200, FEMA award recipient and subrecipient contracts and purchase orders must now include contract provisions for *Domestic Preferences for Procurements* (2 C.F.R. 200.322) and the *Prohibition on Contracting for Covered Telecommunications or Services* (2 C.F.R. 200.316)

2 C.F.R. § 200.317. Procurements by states.

When procuring property and services under a Federal award, a state must follow the same policies and procedures it uses for procurements from its non-Federal funds. The state will comply with §200.322 Procurement of recovered materials and ensure that every purchase order or other contract includes any clauses required by section §200.326 Contract provisions. All other non-Federal entities, including subrecipients of a state, will follow §§ 200.318 General procurement standards through 200.326 Contract provisions.

69 FR 26280, May 11, 2004; 78 FR 78608, Dec. 26, 2013

**REQUEST FOR PROPOSAL
SEPTIC TANK SERVICES – RUNGE PARK
GALVESTON COUNTY, TEXAS**

2 C.F.R. § 200.318. General procurement standards.

- (a) The non-Federal entity must use its own documented procurement procedures which reflect applicable State, local and tribal laws and regulations, provided that the procurements conform to applicable Federal law and the standards identified in this part.
- (b) Non-Federal entities must maintain oversight to ensure that contractors perform in accordance with the terms, conditions, and specifications of their contracts or purchase orders.
- (c)
- (1) The non-Federal entity must maintain written standards of conduct covering conflicts of interest and governing the actions of its employees engaged in the selection, award and administration of contracts. No employee, officer, or agent may participate in the selection, award, or administration of a contract supported by a Federal award if he or she has a real or apparent conflict of interest. Such a conflict of interest would arise when the employee, officer, or agent, any member of his or her immediate family, his or her partner, or an organization which employs or is about to employ any of the parties indicated herein, has a financial or other interest in or a tangible personal benefit from a firm considered for a contract. The officers, employees, and agents of the non-Federal entity may neither solicit nor accept gratuities, favors, or anything of monetary value from contractors or parties to subcontracts. However, non-Federal entities may set standards for situations in which the financial interest is not substantial or the gift is an unsolicited item of nominal value. The standards of conduct must provide for disciplinary actions to be applied for violations of such standards by officers, employees, or agents of the non-Federal entity.
- (2) If the non-Federal entity has a parent, affiliate, or subsidiary organization that is not a state, local government, or Indian tribe, the non-Federal entity must also maintain written standards of conduct covering organizational conflicts of interest. Organizational conflicts of interest means that because of relationships with a parent company, affiliate, or subsidiary organization, the non-Federal entity is unable or appears to be unable to be impartial in conducting a procurement action involving a related organization.
- (d) The non-Federal entity's procedures must avoid acquisition of unnecessary or duplicative items. Consideration should be given to consolidating or breaking out procurements to obtain a more economical purchase. Where appropriate, an analysis will be made of lease versus purchase alternatives, and any other appropriate analysis to determine the most economical approach.
- (e) To foster greater economy and efficiency, and in accordance with efforts to promote cost-effective use of shared services across the Federal Government, the non-Federal entity is encouraged to enter into state and local intergovernmental agreements or inter-entity agreements where appropriate for procurement or use of common or shared goods and services.
- (f) The non-Federal entity is encouraged to use Federal excess and surplus property in lieu of purchasing new equipment and property whenever such use is feasible and reduces project costs.
- (g) The non-Federal entity is encouraged to use value engineering clauses in contracts for construction projects of sufficient size to offer reasonable opportunities for cost reductions. Value engineering is a systematic and creative analysis of each contract item or task to ensure that its essential function is provided at the overall lower cost.
- (h) The non-Federal entity must award contracts only to responsible contractors possessing the ability to perform successfully under the terms and conditions of a proposed procurement. Consideration will be given

**REQUEST FOR PROPOSAL
SEPTIC TANK SERVICES – RUNGE PARK
GALVESTON COUNTY, TEXAS**

to such matters as contractor integrity, compliance with public policy, record of past performance, and financial and technical resources. See also § 200.213 Suspension and debarment.

(i) The non-Federal entity must maintain records sufficient to detail the history of procurement. These records will include, but are not necessarily limited to the following: rationale for the method of procurement, selection of contract type, contractor selection or rejection, and the basis for the contract price.

(j)

(1) The non-Federal entity may use a time and materials type contract only after a determination that no other contract is suitable and if the contract includes a ceiling price that the contractor exceeds at its own risk. Time and materials type contract means a contract whose cost to a non-Federal entity is the sum of:

(i) The actual cost of materials; and

(ii) Direct labor hours charged at fixed hourly rates that reflect wages, general and administrative expenses, and profit.

(2) Since this formula generates an open-ended contract price, a time-and-materials contract provides no positive profit incentive to the contractor for cost control or labor efficiency. Therefore, each contract must set a ceiling price that the contractor exceeds at its own risk. Further, the non-Federal entity awarding such a contract must assert a high degree of oversight in order to obtain reasonable assurance that the contractor is using efficient methods and effective cost controls.

(k) The non-Federal entity alone must be responsible, in accordance with good administrative practice and sound business judgment, for the settlement of all contractual and administrative issues arising out of procurements. These issues include, but are not limited to, source evaluation, protests, disputes, and claims. These standards do not relieve the non-Federal entity of any contractual responsibilities under its contracts. The Federal awarding agency will not substitute its judgment for that of the non-Federal entity unless the matter is primarily a Federal concern. Violations of law will be referred to the local, state, or Federal authority having proper jurisdiction.

78 FR 78608, Dec. 26, 2013, as amended at 79 FR 75885, Dec. 19, 2014; 80 FR 43309, July 22, 2015; 80 FR 45395, July 30, 2015

2 C.F.R. § 200.319. Competition.

(a) All procurement transactions must be conducted in a manner providing full and open competition consistent with the standards of this section. In order to ensure objective contractor performance and eliminate unfair competitive advantage, contractors that develop or draft specifications, requirements, statements of work, or invitations for Proposals or requests for proposals must be excluded from competing for such procurements. Some of the situations considered to be restrictive of competition include but are not limited to:

(1) Placing unreasonable requirements on firms in order for them to qualify to do business;

(2) Requiring unnecessary experience and excessive bonding;

(3) Noncompetitive pricing practices between firms or between affiliated companies;

**REQUEST FOR PROPOSAL
SEPTIC TANK SERVICES – RUNGE PARK
GALVESTON COUNTY, TEXAS**

- (4) Noncompetitive contracts to consultants that are on retainer contracts;
- (5) Organizational conflicts of interest;
- (6) Specifying only a “brand name” product instead of allowing “an equal” product to be offered and describing the performance or other relevant requirements of the procurement; and
- (7) Any arbitrary action in the procurement process.

(b) The non-Federal entity must conduct procurements in a manner that prohibits the use of statutorily or administratively imposed state, local, or tribal geographical preferences in the evaluation of Proposals or proposals, except in those cases where applicable Federal statutes expressly mandate or encourage geographic preference. Nothing in this section preempts state licensing laws. When contracting for architectural and engineering (A/E) services, geographic location may be a selection criterion provided its application leaves an appropriate number of qualified firms, given the nature and size of the project, to compete for the contract.

(c) The non-Federal entity must have written procedures for procurement transactions. These procedures must ensure that all solicitations:

(1) Incorporate a clear and accurate description of the technical requirements for the material, product, or service to be procured. Such description must not, in competitive procurements, contain features which unduly restrict competition. The description may include a statement of the qualitative nature of the material, product or service to be procured and, when necessary, must set forth those minimum essential characteristics and standards to which it must conform if it is to satisfy its intended use. Detailed product specifications should be avoided if at all possible. When it is impractical or uneconomical to make a clear and accurate description of the technical requirements, a “brand name or equivalent” description may be used as a means to define the performance or other salient requirements of procurement. The specific features of the named brand which must be met by offers must be clearly stated; and

(2) Identify all requirements which the offerors must fulfill and all other factors to be used in evaluating Proposals or proposals.

(d) The non-Federal entity must ensure that all prequalified lists of persons, firms, or products which are used in acquiring goods and services are current and include enough qualified sources to ensure maximum open and free competition. Also, the non-Federal entity must not preclude potential Proposers from qualifying during the solicitation period.

78 FR 78608, Dec. 26, 2013, as amended at 79 FR 75885, Dec. 19, 2014

2 C.F.R. § 200.320. Methods of procurement to be followed.

The non-Federal entity must use one of the following methods of procurement.

(a) Procurement by micro-purchases. Procurement by micro-purchase is the acquisition of supplies or services, the aggregate dollar amount of which does not exceed the micro-purchase threshold (§200.67 Micro-purchase). To the extent practicable, the non-Federal entity must distribute micro-purchases equitably among qualified suppliers. Micro-purchases may be awarded without soliciting competitive quotations if the non-Federal entity considers the price to be reasonable.

**REQUEST FOR PROPOSAL
SEPTIC TANK SERVICES – RUNGE PARK
GALVESTON COUNTY, TEXAS**

(b) Procurement by small purchase procedures. Small purchase procedures are those relatively simple and informal procurement methods for securing services, supplies, or other property that do not cost more than the Simplified Acquisition Threshold. If small purchase procedures are used, price or rate quotations must be obtained from an adequate number of qualified sources.

(c) Procurement by sealed Proposals (formal advertising). Proposals are publicly solicited and a firm fixed price contract (lump sum or unit price) is awarded to the responsible Proposer whose bid, conforming with all the material terms and conditions of the Request for Proposals, is the lowest in price. The sealed bid method is the preferred method for procuring construction, if the conditions in paragraph (c)(1) of this section apply.

(1) In order for sealed bidding to be feasible, the following conditions should be present:

- (i) A complete, adequate, and realistic specification or purchase description is available;
- (ii) Two or more responsible Proposers are willing and able to compete effectively for the business; and
- (iii) The procurement lends itself to a firm fixed price contract and the selection of the successful Proposer can be made principally on the basis of price.

(2) If sealed bids are used, the following requirements apply:

- (i) Bids must be solicited from an adequate number of known suppliers, providing them sufficient response time prior to the date set for opening the bids, for local, and tribal governments, the invitation for bids must be publicly advertised;
- (ii) The invitation for bids, which will include any specifications and pertinent attachments, must define the items or services in order for the Proposer to properly respond;
- (iii) All bids will be opened at the time and place prescribed in the invitation for bids, and for local and tribal governments, the bids must be opened publicly;
- (iv) A firm fixed price contract award will be made in writing to the lowest responsive and responsible Proposer. Where specified in bidding documents, factors such as discounts, transportation cost, and life cycle costs must be considered in determining which bid is lowest. Payment discounts will only be used to determine the low bid when prior experience indicates that such discounts are usually taken advantage of; and
- (v) Any or all bids may be rejected if there is a sound documented reason.

(d) Procurement by competitive proposals. The technique of competitive proposals is normally conducted with more than one source submitting an offer, and either a fixed price or cost-reimbursement type contract is awarded. It is generally used when conditions are not appropriate for the use of sealed bids. If this method is used, the following requirements apply:

(1) Requests for proposals must be publicized and identify all evaluation factors and their relative importance. Any response to publicized requests for proposals must be considered to the maximum extent practical;

(2) Proposals must be solicited from an adequate number of qualified sources;

**REQUEST FOR PROPOSAL
SEPTIC TANK SERVICES – RUNGE PARK
GALVESTON COUNTY, TEXAS**

(3) The non-Federal entity must have a written method for conducting technical evaluations of the proposals received and for selecting recipients;

(4) Contracts must be awarded to the responsible firm whose proposal is most advantageous to the program, with price and other factors considered; and

(5) The non-Federal entity may use competitive proposal procedures for qualifications-based procurement of architectural/engineering (A/E) professional services whereby competitors' qualifications are evaluated and the most qualified competitor is selected, subject to negotiation of fair and reasonable compensation. The method, where price is not used as a selection factor, can only be used in procurement of A/E professional services. It cannot be used to purchase other types of services though A/E firms are a potential source to perform the proposed effort.

(e) [Reserved]

(f) Procurement by noncompetitive proposals. Procurement by noncompetitive proposals is procurement through solicitation of a proposal from only one source and may be used only when one or more of the following circumstances apply:

(1) The item is available only from a single source;

(2) The public exigency or emergency for the requirement will not permit a delay resulting from competitive solicitation;

(3) The Federal awarding agency or pass-through entity expressly authorizes noncompetitive proposals in response to a written request from the non-Federal entity; or

(4) After solicitation of a number of sources, competition is determined inadequate.

78 FR 78608, Dec. 26, 2013, as amended at 79 FR 75885, Dec. 19, 2014; 80 FR 54409, Sept. 10, 2015

2 C.F.R. § 200.321. Contracting with small and minority businesses, women's business enterprises, and labor surplus area firms.

(a) The non-Federal entity must take all necessary affirmative steps to assure that minority businesses, women's business enterprises, and labor surplus area firms are used when possible.

(b) Affirmative steps must include:

(1) Placing qualified small and minority businesses and women's business enterprises on solicitation lists;

(2) Assuring that small and minority businesses, and women's business enterprises are solicited whenever they are potential sources;

(3) Dividing total requirements, when economically feasible, into smaller tasks or quantities to permit maximum participation by small and minority businesses, and women's business enterprises;

(4) Establishing delivery schedules, where the requirement permits, which encourage participation by small and minority businesses, and women's business enterprises;

**REQUEST FOR PROPOSAL
SEPTIC TANK SERVICES – RUNGE PARK
GALVESTON COUNTY, TEXAS**

(5) Using the services and assistance, as appropriate, of such organizations as the Small Business Administration and the Minority Business Development Agency of the Department of Commerce; and

(6) Requiring the prime contractor, if subcontracts are to be let, to take the affirmative steps listed in paragraphs (1) through (5) of this section.

69 FR 26280, May 11, 2004; 78 FR 78608, Dec. 26, 2013, unless otherwise noted

2 C.F.R. § 200.322. Procurement of recovered materials.

A non-Federal entity that is a state agency or agency of a political subdivision of a state and its contractors must comply with section 6002 of the Solid Waste Disposal Act, as amended by the Resource Conservation and Recovery Act. The requirements of Section 6002 include procuring only items designated in guidelines of the Environmental Protection Agency (EPA) at 40 CFR part 247 that contain the highest percentage of recovered materials practicable, consistent with maintaining a satisfactory level of competition, where the purchase price of the item exceeds \$10,000 or the value of the quantity acquired during the preceding fiscal year exceeded \$10,000; procuring solid waste management services in a manner that maximizes energy and resource recovery; and establishing an affirmative procurement program for procurement of recovered materials identified in the EPA guidelines.

78 FR 78608, Dec. 26, 2013, as amended at 79 FR 75885, Dec. 19, 2014

2 C.F.R. § 200.323. Contract cost and price.

(a) The non-Federal entity must perform a cost or price analysis in connection with every procurement action in excess of the Simplified Acquisition Threshold including contract modifications. The method and degree of analysis is dependent on the facts surrounding the particular procurement situation, but as a starting point, the non-Federal entity must make independent estimates before receiving bids or proposals.

(b) The non-Federal entity must negotiate profit as a separate element of the price for each contract in which there is no price competition and in all cases where cost analysis is performed. To establish a fair and reasonable profit, consideration must be given to the complexity of the work to be performed, the risk borne by the contractor, the contractor's investment, the amount of subcontracting, the quality of its record of past performance, and industry profit rates in the surrounding geographical area for similar work.

(c) Costs or prices based on estimated costs for contracts under the Federal award are allowable only to the extent that costs incurred or cost estimates included in negotiated prices would be allowable for the non-Federal entity under Subpart E—Cost Principles of this part. The non-Federal entity may reference its own cost principles that comply with the Federal cost principles.

(d) The cost plus a percentage of cost and percentage of construction cost methods of contracting must not be used.

69 FR 26280, May 11, 2004; 78 FR 78608, Dec. 26, 2013, unless otherwise noted

2 C.F.R. § 200.324. Federal awarding agency or pass-through entity review.

(a) The non-Federal entity must make available, upon request of the Federal awarding agency or pass-through entity, technical specifications on proposed procurements where the Federal awarding agency or pass-through entity believes such review is needed to ensure that the item or service specified is the one being proposed for acquisition. This review generally will take place prior to the time the specification is incorporated into a solicitation document. However, if the non-Federal entity desires to have the review accomplished after a solicitation has been developed, the Federal awarding

**REQUEST FOR PROPOSAL
SEPTIC TANK SERVICES – RUNGE PARK
GALVESTON COUNTY, TEXAS**

agency or pass-through entity may still review the specifications, with such review usually limited to the technical aspects of the proposed purchase.

(b) The non-Federal entity must make available upon request, for the Federal awarding agency or pass-through entity pre-procurement review, procurement documents, such as requests for proposals or invitations for bids, or independent cost estimates, when:

- (1) The non-Federal entity's procurement procedures or operation fails to comply with the procurement standards in this part;
- (2) The procurement is expected to exceed the Simplified Acquisition Threshold and is to be awarded without competition or only one bid or offer is received in response to a solicitation;
- (3) The procurement, which is expected to exceed the Simplified Acquisition Threshold, specifies a "brand name" product;
- (4) The proposed contract is more than the Simplified Acquisition Threshold and is to be awarded to other than the apparent low Proposer under a sealed bid procurement; or
- (5) A proposed contract modification changes the scope of a contract or increases the contract amount by more than the Simplified Acquisition Threshold.

(c) The non-Federal entity is exempt from the pre-procurement review in paragraph (b) of this section if the Federal awarding agency or pass-through entity determines that its procurement systems comply with the standards of this part.

(1) The non-Federal entity may request that its procurement system be reviewed by the Federal awarding agency or pass-through entity to determine whether its system meets these standards in order for its system to be certified. Generally, these reviews must occur where there is continuous high-dollar funding, and third party contracts are awarded on a regular basis;

(2) The non-Federal entity may self-certify its procurement system. Such self-certification must not limit the Federal awarding agency's right to survey the system. Under a self-certification procedure, the Federal awarding agency may rely on written assurances from the non-Federal entity that it is complying with these standards. The non-Federal entity must cite specific policies, procedures, regulations, or standards as being in compliance with these requirements and have its system available for review.

69 FR 26280, May 11, 2004; 78 FR 78608, Dec. 26, 2013, unless otherwise noted

2 C.F.R. § 200.325. Bonding requirements.

For construction or facility improvement contracts or subcontracts exceeding the Simplified Acquisition Threshold, the Federal awarding agency or pass-through entity may accept the bonding policy and requirements of the non-Federal entity provided that the Federal awarding agency or pass-through entity has made a determination that the Federal interest is adequately protected. If such a determination has not been made, the minimum requirements must be as follows:

(a) A bid guarantee from each Proposer equivalent to five percent of the bid price. The "bid guarantee" must consist of a firm commitment such as a bid bond, certified check, or other negotiable instrument accompanying a bid as assurance that the Proposer will, upon acceptance of the bid, execute such contractual documents as may be required within the time specified.

(b) A performance bond on the part of the contractor for 100 percent of the contract price. A "performance bond" is one executed in connection with a contract to secure fulfillment of all the contractor's obligations under such contract.

**REQUEST FOR PROPOSAL
SEPTIC TANK SERVICES – RUNGE PARK
GALVESTON COUNTY, TEXAS**

(c) A payment bond on the part of the contractor for 100 percent of the contract price. A “payment bond” is one executed in connection with a contract to assure payment as required by law of all persons supplying labor and material in the execution of the work provided for in the contract.

69 FR 26280, May 11, 2004; 78FR 78608, Dec. 26, 2013, unless otherwise noted

2 C.F.R. § 200.326. Contract provisions.

The non-Federal entity's contracts must contain the applicable provisions described in Appendix II to Part 200—Contract Provisions for non-Federal Entity Contracts Under Federal Awards.

69 FR 26280, May 11, 2004; 78 FR 78608, Dec. 26, 2013, unless otherwise note

2 C.F.R. Part, 200, Appendix II

In addition to other provisions required by the Federal agency or non-Federal entity, all contracts made by the non-Federal entity under the Federal award must contain provisions covering the following, as applicable.

(A) Contracts for more than the simplified acquisition threshold currently set at \$150,000, which is the inflation adjusted amount determined by the Civilian Agency Acquisition Council and the Defense Acquisition Regulations Council (Councils) as authorized by 41 U.S.C. 1908, must address administrative, contractual, or legal remedies in instances where contractors violate or breach contract terms, and provide for such sanctions and penalties as appropriate.

(B) All contracts in excess of \$10,000 must address termination for cause and for convenience by the non-Federal entity including the manner by which it will be affected and the basis for settlement.

(C) Equal Employment Opportunity. Except as otherwise provided under 41 CFR Part 60, all contracts that meet the definition of “federally assisted construction contract” in 41 CFR Part 60-1.3 must include the equal opportunity clause provided under 41 CFR 60-1.4(b), in accordance with Executive Order 11246, “Equal Employment Opportunity” (30 FR 12319, 12935, 3 CFR Part, 1964-1965 Comp., p. 339), as amended by Executive Order 11375, “Amending Executive Order 11246 Relating to Equal Employment Opportunity,” and implementing regulations at 41 CFR part 60, “Office of Federal Contract Compliance Programs, Equal Employment Opportunity, Department of Labor.”

(D) Davis-Bacon Act, as amended (40 U.S.C. 3141-3148). When required by Federal program legislation, all prime construction contracts in excess of \$2,000 awarded by non-Federal entities must include a provision for compliance with the Davis-Bacon Act (40 U.S.C. 3141-3144, and 3146-3148) as supplemented by Department of Labor regulations (29 CFR Part 5, “Labor Standards Provisions Applicable to Contracts Covering Federally Financed and Assisted Construction”). In accordance with the statute, contractors must be required to pay wages to laborers and mechanics at a rate not less than the prevailing wages specified in a wage determination made by the Secretary of Labor. In addition, contractors must be required to pay wages not less than once a week. The non-Federal entity must place a copy of the current prevailing wage determination issued by the Department of Labor in each solicitation. The decision to award a contract or subcontract must be conditioned upon the acceptance of the wage determination. The non-Federal entity must report all suspected or reported violations to the Federal awarding agency. The contracts must also include a provision for compliance with the Copeland “Anti-Kickback” Act (40 U.S.C. 3145), as supplemented by Department of Labor regulations (29 CFR Part 3, “Contractors and Subcontractors on Public Building or Public Work Financed in Whole or in Part by Loans or Grants from the United States”). The Act provides that each contractor or subrecipient must be prohibited from inducing, by any means, any person employed in the construction, completion, or repair of public work, to give up any part of the compensation to which he or she is otherwise entitled. The non-Federal entity must report all suspected or reported violations to the Federal awarding agency.

**REQUEST FOR PROPOSAL
SEPTIC TANK SERVICES – RUNGE PARK
GALVESTON COUNTY, TEXAS**

(E) Contract Work Hours and Safety Standards Act (40 U.S.C. 3701-3708). Where applicable, all contracts awarded by the non-Federal entity in excess of \$100,000 that involve the employment of mechanics or laborers must include a provision for compliance with 40 U.S.C. 3702 and 3704, as supplemented by Department of Labor regulations (29 CFR Part 5). Under 40 U.S.C. 3702 of the Act, each contractor must be required to compute the wages of every mechanic and laborer on the basis of a standard work week of 40 hours. Work in excess of the standard work week is permissible provided that the worker is compensated at a rate of not less than one and a half times the basic rate of pay for all hours worked in excess of 40 hours in the work week. The requirements of 40 U.S.C. 3704 are applicable to construction work and provide that no laborer or mechanic must be required to work in surroundings or under working conditions which are unsanitary, hazardous or dangerous. These requirements do not apply to the purchases of supplies or materials or articles ordinarily available on the open market, or contracts for transportation or transmission of intelligence.

(F) Rights to Inventions Made Under a Contract or Agreement. If the Federal award meets the definition of “funding agreement” under 37 CFR §401.2 (a) and the recipient or subrecipient wishes to enter into a contract with a small business firm or nonprofit organization regarding the substitution of parties, assignment or performance of experimental, developmental, or research work under that “funding agreement,” the recipient or subrecipient must comply with the requirements of 37 CFR Part 401, “Rights to Inventions Made by Nonprofit Organizations and Small Business Firms Under Government Grants, Contracts and Cooperative Agreements,” and any implementing regulations issued by the awarding agency.

(G) Clean Air Act (42 U.S.C. 7401-7671q.) and the Federal Water Pollution Control Act (33 U.S.C. 1251-1387), as amended—Contracts and subgrants of amounts in excess of \$150,000 must contain a provision that requires the non-Federal award to agree to comply with all applicable standards, orders or regulations issued pursuant to the Clean Air Act (42 U.S.C. 7401-7671q) and the Federal Water Pollution Control Act as amended (33 U.S.C. 1251-1387). Violations must be reported to the Federal awarding agency and the Regional Office of the Environmental Protection Agency (EPA).

(H) Debarment and Suspension (Executive Orders 12549 and 12689)—A contract award (see 2 CFR 180.220) must not be made to parties listed on the governmentwide exclusions in the System for Award Management (SAM), in accordance with the OMB guidelines at 2 CFR 180 that implement Executive Orders 12549 (3 CFR part 1986 Comp., p. 189) and 12689 (3 CFR part 1989 Comp., p. 235), “Debarment and Suspension.” SAM Exclusions contains the names of parties debarred, suspended, or otherwise excluded by agencies, as well as parties declared ineligible under statutory or regulatory authority other than Executive Order 12549.

(I) Byrd Anti-Lobbying Amendment (31 U.S.C. 1352)—Contractors that apply or bid for an award exceeding \$100,000 must file the required certification. Each tier certifies to the tier above that it will not and has not used Federal appropriated funds to pay any person or organization for influencing or attempting to influence an officer or employee of any agency, a member of Congress, officer or employee of Congress, or an employee of a member of Congress in connection with obtaining any Federal contract, grant or any other award covered by 31 U.S.C. 1352. Each tier must also disclose any lobbying with non-Federal funds that takes place in connection with obtaining any Federal award. Such disclosures are forwarded from tier to tier up to the non-Federal award.

(J) See §200.322 Procurement of recovered materials.

78 FR 78608, Dec. 26, 2013, as amended at 79 FR 75888, Dec. 19, 2014

DOMESTIC PREFERENCES FOR PROCUREMENTS *(All State and non-State entity purchase orders must adhere to the following)*

§ 200.322 Domestic preferences for procurements.

(a) As appropriate and to the extent consistent with law, the non-Federal entity should, to the greatest extent practicable under a Federal award, provide a preference for the purchase, acquisition, or use of goods, products, or materials produced in the United States (including but not limited to iron, aluminum, steel, cement, and other

**REQUEST FOR PROPOSAL
SEPTIC TANK SERVICES – RUNGE PARK
GALVESTON COUNTY, TEXAS**

manufactured products). The requirements of this section must be included in all subawards including all contracts and purchase orders for work or products under this award.

(b) For purposes of this section:

(1) “Produced in the United States” means, for iron and steel products, that all manufacturing processes, from the initial melting stage through the application of coatings, occurred in the United States.

(2) “Manufactured products” means items and construction materials composed in whole or in part of non-ferrous metals such as aluminum; plastics and polymer-based products such as polyvinyl chloride pipe; aggregates such as concrete; glass, including optical fiber; and lumber.

PROHIBITION ON CONTRACTING FOR COVERED TELECOMMUNICATIONS OR SERVICES
(Effective August 13, 2020 for new, extended, or renewed procurements under all open FEMA awards)

§ 200.216 Prohibition on certain telecommunications and video surveillance services or equipment.

(a) Recipients and subrecipients are prohibited from obligating or expending loan or grant funds to:

(1) Procure or obtain;

(2) Extend or renew a contract to procure or obtain; or

(3) Enter into a contract (or extend or renew a contract) to procure or obtain equipment, services, or systems that uses covered telecommunications equipment or services as a substantial or essential component of any system, or as critical technology as part of any system. As described in Public Law 115-232, section 889, covered telecommunications equipment is telecommunications equipment produced by Huawei Technologies Company or ZTE Corporation (or any subsidiary or affiliate of such entities).

(i) For the purpose of public safety, security of government facilities, physical security surveillance of critical infrastructure, and other national security purposes, video surveillance and telecommunications equipment produced by Hytera Communications Corporation, Hangzhou Hikvision Digital Technology Company, or Dahua Technology Company (or any subsidiary or affiliate of such entities).

(ii) Telecommunications or video surveillance services provided by such entities or using such equipment.

(iii) Telecommunications or video surveillance equipment or services produced or provided by an entity that the Secretary of Defense, in consultation with the Director of the National Intelligence or the Director of the Federal Bureau of Investigation, reasonably believes to be an entity owned or controlled by, or otherwise connected to, the government of a covered foreign country.

(b) In implementing the prohibition under Public Law 115-232, section 889, subsection (f), paragraph (1), heads of executive agencies administering loan, grant, or subsidy programs shall prioritize available funding and technical support to assist affected businesses, institutions and organizations as is reasonably necessary for those affected entities to transition from covered communications equipment and services, to procure replacement equipment and services, and to ensure that communications service to users and customers is sustained.

(c) See Public Law 115-232, section 889 for additional information.

**REQUEST FOR PROPOSAL
SEPTIC TANK SERVICES – RUNGE PARK
GALVESTON COUNTY, TEXAS**

(c) See also § 200.471.

69. PROCUREMENT LAWS

- a. Proposer shall comply with all applicable local, State, and Federal laws, rules, and regulations.
- b. If this contract is made pursuant to a federal award, then Contractor acknowledges that the contract is subject, without limitation, to applicable provisions within 2 C.F.R. Part 200, Uniform Administrative Requirements, Cost Principles, and Audit Requirements for Federal Awards. Contractor shall comply with applicable provisions within 2 C.F.R., Sections 200.319 through 200.326, including but not limited to the following:
 - 1.) **Equal Employment Opportunity**, 41 C.F.R. Part 60-1.4(b) (applicable to federally assisted construction contracts).
 - (a) During the performance of this contract, the contractor agrees as follows:
 - (1) The contractor will not discriminate against any employee or applicant for employment because of race, color, religion, sex, national original, disability, or veteran status. The contractor will take affirmative action to ensure that applicants are employed, and that employees are treated during employment, without regard to their race, color, religion, sex, national original, disability or veteran status. Such action shall include, but not be limited to the following: employment, upgrading, demotion, or transfer; recruitment or recruitment advertising; layoff or termination; rates of pay or other forms of compensation; and selection for training, including apprenticeship. The contractor agrees to post in conspicuous places, available to employees and applicants for employment, notices to be provided setting forth the provisions of this nondiscrimination clause.
 - (2) The contractor will, in all solicitations or advertisements for employees placed by or on behalf of contractor, state that all qualified applicants will receive consideration for employment without regard to race, color, religion, sex, national original, disability, or veteran status.
 - (3) The contractor will send to each labor union or representative of workers with which he has a collective bargaining agreement or other contract or understanding, a notice to be provided advising the said labor union or workers' representatives of the contractor's commitments under this section and shall post copies of the notice in conspicuous places available to employees and applicants for employment.
 - (4) The contractor will comply with all provisions of Executive Order 11246 of September 24, 1965, and by rules, regulations, and relevant orders of the Secretary of Labor.
 - (5) The contractor will furnish all information and reports required by Executive Order 11246 of September 24, 1965, and by rules, regulations, and orders of the Secretary of Labor, or pursuant thereto, and will permit access to contractor's books, records, and accounts by the administering agency and the Secretary of Labor for purposes of investigation to ascertain compliance with such rules, regulations, and orders.
 - (6) In the event of the contractor's noncompliance with the nondiscrimination clauses of this contract or with any of the said rules, regulations, or orders, this contract may be cancelled, terminated, or suspended in whole or in part and the contractor may be declared ineligible for further Government contracts or federally assisted construction contracts in accordance with procedures authorized in Executive Order 11246 of September 24, 1965, and such other sanctions as may be imposed and remedies invoked as provided in

**REQUEST FOR PROPOSAL
SEPTIC TANK SERVICES – RUNGE PARK
GALVESTON COUNTY, TEXAS**

Executive Order 11246 of September 24, 1965, or by rule, regulation, or order of the Secretary of Labor, or as otherwise provided by law.

- (7) The contractor will include the portion of the sentence immediately preceding paragraph (1) and the provisions of paragraphs (1) through (7) in every subcontract or purchase order unless exempted by rules, regulations, or orders of the Secretary of Labor issued pursuant to section 204 of Executive Order 11246 of September 24, 1965, so that such provisions will be binding upon each subcontractor or vendor. The contractor will take such action with respect to any subcontract or purchase order as the administering agency may direct as a means of enforcing such provisions, including sanctions for noncompliance: Provided, however, that in the event a contractor becomes involved in, or is threatened with, litigation with a subcontractor or vendor as a result of such direction by the administering agency, the contractor may request the United States to enter into such litigation to protect the interests of the United States.
- 2.) **Small and minority business, women’s business enterprises, and labor surplus area firms (2 C.F.R. § 200.321).** The County is required to take affirmative steps to assure that minority businesses, women’s business enterprises, and labor surplus area firms are used when possible. This includes requiring the prime contractor, if subcontracts are to be let in the performance of this contract, to itself take affirmative steps in letting the subcontract. Accordingly, if subcontracts are to be let in the performance of this contract, the contractor must take affirmative steps in the letting of the subcontract(s), which must include:
- (a) placing qualified small and minority businesses and women’s business enterprises on solicitation lists;
 - (b) assuring that small and minority businesses, and women’s business enterprises are solicited whenever they are potential sources;
 - (c) dividing total requirements, when economically feasible, into smaller tasks or quantities to permit maximum participation by small and minority businesses, and women’s business enterprises; and
 - (d) using the services and assistance, as appropriate, of such organizations as the Small Business Administration and the Minority Business Development Agency of the Department of Commerce.

In accordance with FEMA procurement guidance:

A small business is a business that is independently owned and operated, not dominant in the field of operation in which it is bidding on Galveston County contracts and qualified as a small business under the Small Business Administration criteria and size standards at 13 C.F.R. Part 121.

A women’s business enterprise is a business enterprise that is: (a) at least 51 percent owned by one or more women or, in the case of a publicly owned business, at least 51 percent of the stock is owned by one or more women; and (b) whose management and daily operations are controlled by one or more women.

A minority business is a business that is (a) at least 51 percent owned by one or more minority group members or, in the case of a publicly owned business, at least 51 percent of the stock is owned by one or more minority group members; and (b) whose management and daily operations are controlled by one or more minority group members.

- 3.) **Davis-Bacon Act as amended (40 U.S.C. 3141-3148).** When required by Federal program legislation, all prime construction contracts in excess of \$2,000 must include a provision for compliance with the Davis-Bacon Act as supplemented by the Department of Labor regulations (29 C.F.R. Part 5, “Labor Standards Provisions Applicable to Contracts Covering Federally Financed and Assisted Construction”). In accordance with the statute, contractor must be required to pay wages to laborers and mechanics at a rate not less than the prevailing wages specified in a wage determination made by the Secretary of Labor. In addition, contractors must be required to pay wages not less than once a week. The non-Federal entity (the County) must place a copy of the current prevailing wage determination issued by the Department of Labor in each solicitation. The decision to award a contract or subcontract must be condition upon the acceptance of the wage determination. The non-Federal entity must report all suspected or reported violations to the Federal awarding agency. The contract must also include a provision for compliance with the Copeland Anti-Kickback Act (40 U.S.C. § 3145) as supplemented by the Department of Labor regulations (29

**REQUEST FOR PROPOSAL
SEPTIC TANK SERVICES – RUNGE PARK
GALVESTON COUNTY, TEXAS**

C.F.R. Part 3, “Contractors and Subcontractors on Public Building or Public Work Financed in Whole or in Part by Loans or Grants from the United States”).

- 4.) **Compliance with the Copeland “Anti-Kickback” Act.** Contractor is prohibited from inducing, by any means, any person employed in the construction, completion, or repair of public work, to give up any part of the compensation to which the person is otherwise entitled. The non-Federal entity must report all suspected or reported violations to the Federal awarding agency. “Whoever, by force, intimidation, or threat of procuring dismissal from employment, or by any other manner whatsoever induces any person employed in the construction, prosecution, completion or repair of any public building, public work, or building or work financed in whole or in part by loans or grants from the United States, to give up any part of the compensation to which he is entitled under his contract of employment, shall be fined under this title [Title 18, U.S.C.] or imprisoned not more than five years, or both.” 18 U.S.C. § 874.
- (a) Contractor shall comply with 18 U.S.C. § 874, 40 U.S.C. § 3145, and the requirements of 29 C.F.R. Part 3 as may be applicable, which are incorporated by reference into this contract.
 - (b) The contractor or subcontractor shall insert in any subcontracts the clause above and such other clauses as the Federal awarding agency may be appropriate instructions require, and also a clause requiring the subcontractors to include these clauses in any lower tier subcontracts. The prime contractor shall be responsible for the compliance by any subcontractor or lower tier subcontractor with all of these contract clauses.
 - (c) Breach. A breach of the contract clause above may be grounds for termination of the contract, and for debarment as a contractor and subcontractor as provided in 29 C.F.R. § 5.12.
- 5.) **Contract Work Hours and Safety Standards Act.**
- (a) Where applicable, all contracts awarded by the County in excess of \$100,000 that involve the employment of mechanics or laborers must include a provision for compliance with 40 U.S.C. §§ 3702 and 3704, as supplemented by the Department of Labor regulations at 29 C.F.R. Part 5. Under 40 U.S.C. § 3702 of the Contract Work Hours and Safety Standards Act, each contractor must be required to compute the wages of every mechanic and laborer on the basis of a standard work week of 40 hours. Work in excess of the standard work week is permissible provided that the worker is compensated at a rate of not less than one and a half times the basic rate of pay for all hours worked in excess of 40 hours in the work week. The requirements of 40 U.S.S. 3704 are applicable to construction work and provide that no laborer or mechanic must be required to work in surroundings or under working conditions which are unsanitary, hazardous or dangerous. These requirements do not apply to the purchase of supplies or material or articles ordinarily available on the open market, or contractors for transportation or transmission of intelligence.
 - (b) **Compliance with the Contract Work Hours and Safety Standards Act.**
 - (1) Overtime requirements. No contractor or subcontractor contracting for any part of the contract work which may require or involve the employment of laborers or mechanics shall require or permit any such laborer or mechanic in any workweek in which he or she is employed on such work to work in excess of forty hours in such workweek unless such laborer or mechanic receives compensation at a rate not less than one and one-half times the basic rate of pay for all hours worked in excess of forty hours in such workweek.
 - (2) Violation; liability for unpaid wages; liquidated damages. In the event of any violation of the clause set forth in paragraph (1) of this subsection the contractor and any subcontractor responsible therefor shall be liable for the unpaid wages. In addition, such contractor and subcontractor shall be liable to the United States (in the case of work done under contract for the District of Columbia or a territory, to such District or to such territory), for liquidated damages. Such liquidated damages shall be computed with respect to each individual laborer or mechanic, including watchmen and guards, employed in violation of the clause set forth in paragraph (1) of this subsection, in the sum of \$10 for each calendar day on which such individual was

**REQUEST FOR PROPOSAL
SEPTIC TANK SERVICES – RUNGE PARK
GALVESTON COUNTY, TEXAS**

required or permitted to work in excess of the standard work week of forty hours without payment of the overtime wages required by the clause set forth in paragraph (1) of this subsection.

- (3) Withholding for unpaid wages and liquidated damages. The awarding Federal agency, State agency, or the County shall upon its own action or upon written request of an authorized representative of the Department of Labor withhold or cause to be withheld, from any moneys payable on account of work performed by the contractor or subcontractor under any such contract or any other Federal contract with the same prime contractor, or any other federally-assisted contract subject to the Contract Work Hours and Safety Standards Act, which is held by the same prime contractor, such sums as may be determined to be necessary to satisfy any liabilities of such contractor or subcontractor for unpaid wages and liquidated damages as provided in the clause set forth in paragraph (2) of this subsection.
- (4) Subcontracts. The contractor or subcontractor shall insert in any subcontracts the clauses set forth in paragraph (1) through (4) of this subsection and also a clause requiring the subcontractors to include these clauses in any lower tier subcontracts. The prime contractor shall be responsible for compliance by any subcontractor or lower tier subcontractor with the clauses set forth in paragraphs (1) through (4) of this subsection.

6.) Rights to Inventions Made Under a Contractor Agreement.

- (a) If the Federal award meets the definition of “funding agreement” under 37 C.F.R. § 401.2(a) and the recipient or subrecipient wishes to enter into a contract with a small business firm or nonprofit organization regarding the substitution of parties, assignment or performance of experimental, developmental, or research work under the “funding agreement,” the recipient or subrecipient must comply with the requirements of 37 C.F.R. Part 401, “Rights to Inventions Made by Nonprofit Organizations and Small Business Firms Under Government Grants, Contracts and Cooperative Agreements,” and any implementing regulations issued by the awarding agency.
- (b) Stafford Act Disaster Grants. This requirement does not apply to Public Assistance, Hazard Mitigation Grant Program, Crisis Counseling Assistance and Training Grant program, Disaster Case Management Grant Program, and Federal Assistance to Individuals and Households – Other Needs Assistance Grant Program, as FEMA awards under these programs do not meet the definition of “funding agreement.”
- (c) The regulations and 37 C.F.R. § 401.2(a) currently defines “funding agreement” as any contract, grant, or cooperative agreement entered into between any Federal agency, other than the Tennessee Valley Authority, and any contractor for the performance of experimental, developmental, or research work funded in whole or in part by the Federal government. This term also includes any assignment, substitution of parties, or subcontract of any type entered into for the performance of experimental, developmental, or research work under a funding agreement as defined in the first sentence of this paragraph.

7.) Clean Air Act (42 U.S.C. §§ 7401 – 7671q) and the Federal Water Pollution Control Act 33 U.S.C. §§ 1251-1387), as amended.

- (a) The contractor agrees to comply with all applicable standards, orders or regulations issued pursuant to the Clean Air Act, as amended, 42 U.S.C. § 7401, et seq., and agrees to comply with all applicable standards, orders, or regulations issued pursuant to the Federal Water Pollution Contract Act, as amended, 33 U.S.C. § 1251, et seq.
- (b) The contractor agrees to report each violation of the Clean Air Act and/or the Federal Water Pollution Control Act to the Federal awarding agency, the State agency administering the grant, and the Regional Office of the Environmental Protection Agency (EPA) and understands and agrees that the Federal awarding agency, the State agency, and the EPA will, in turn, report each violation as required to assure notification to Galveston County, the Federal Emergency Management Agency, and the appropriate EPA Regional Office.

**REQUEST FOR PROPOSAL
SEPTIC TANK SERVICES – RUNGE PARK
GALVESTON COUNTY, TEXAS**

- 8.) **Debarment and Suspension (Executive Orders 12549 and 12689).** A contract award must not be made to parties listed on the government-wide exclusions in the System for Award Management (SAM), in accordance with the OMB guidelines at 2 C.F.R. Part 180 that implement Executive Orders 12549 and 12689. The Contractor is required to verify that none of the contractor, its principals (defined at 2 C.F.R. § 180.995), or its affiliates (defined at 2 C.F.R. § 180.905) are excluded (defined at 2 C.F.R. § 180.940) or disqualified (defined at 2 C.F.R. § 180.935).

Contractor must comply with 2 C.F.R. Part 180, Subpart C and 2 C.F.R. Part 3000, Subpart C, and must include a requirement to comply with these regulations in any lower tier covered transaction it enters into. Proposer agrees to comply with the requirements of 2 C.F.R. Part 180, Subpart C, and 2 C.F.R. Part 3000, Subpart C, while this offer is valid and through the period of any contract that may arise from this offer. The Proposer further agrees to include a provision requiring such compliance in its lower tier covered transactions.

- 9.) **Domestic Preferences for Procurements (2 C.F.R. § 200.323)**

(a) As appropriate and to the extent consistent with law, the non-Federal entity should, to the greatest extent practicable under a Federal award, provide a preference for the purchase, acquisition, or use of goods, products, or materials produced in the United States (including but not limited to iron, aluminum, steel, cement, and other manufactured products). The requirements of this section must be included in all subawards including all contracts and purchase orders for work or products under this award.

(c) For purposes of this section:

(1) “Produced in the United States” means, for iron and steel products, that all manufacturing processes, from the initial melting stage through the application of coatings, occurred in the United States.

(2) “Manufactured products” means items and construction materials composed in whole or in part of non-ferrous metals such as aluminum; plastics and polymer-based products such as polyvinyl chloride pipe; aggregates such as concrete; glass, including optical fiber; and lumber.

- 10.) **Prohibition on Certain Telecommunications and Video Surveillance Services or Equipment.
(2 C.F.R. § 200.216)**

(a) Recipients and subrecipients are prohibited from obligating or expending loan or grant funds to:

(1) Procure or obtain;

(2) Extend or renew a contract to procure or obtain; or

(2) Enter into a contract (or extend or renew a contract) to procure or obtain equipment, services, or systems that uses covered telecommunications equipment or services as a substantial or essential component of any system, or as critical technology as part of any system.

As described in Public Law 115-232, section 889, covered telecommunications equipment is telecommunications equipment produced by Huawei Technologies Company or ZTE Corporation (or any subsidiary or affiliate of such entities).

(i) For the purpose of public safety, security of government facilities, physical security surveillance of critical infrastructure, and other national security purposes, video surveillance and telecommunications equipment produced by Hytera Communications Corporation, Hangzhou Hikvision Digital Technology Company, or Dahua Technology Company (or any subsidiary or affiliate of such entities).

**REQUEST FOR PROPOSAL
SEPTIC TANK SERVICES – RUNGE PARK
GALVESTON COUNTY, TEXAS**

(ii) Telecommunications or video surveillance services provided by such entities or using such equipment.

(iii) Telecommunications or video surveillance equipment or services produced or provided by an entity that the Secretary of Defense, in consultation with the Director of the National Intelligence or the Director of the Federal Bureau of Investigation, reasonably believes to be an entity owned or controlled by, or otherwise connected to, the government of a covered foreign country.

(b) In implementing the prohibition under Public Law 115-232, section 889 of the John S. McCain National Defense Authorization Act for Fiscal Year 2019 (FY 2019 NDAA), Pub. L. No. 115-232 (2018) and 2 C.F.R. 200.216, 200.327, 200.471, and Appendix II to C.F.R. Part 200, subsection (f), paragraph (1), heads of executive agencies administering loan, grant, or subsidy programs shall prioritize available funding and technical support to assist affected businesses, institutions and organizations as is reasonably necessary for those affected entities to transition from covered communications equipment and services, to procure replacement equipment and services, and to ensure that communications service to users and customers is sustained.

(c) See Public Law 115-232, section 889 for additional information.

(d) See also § 200.471.

11.) Procurement of Recovered Materials (2 C.F.R. § 200.323)

(a.) A non-Federal entity that is a State agency or agency of a political subdivision of the State and its contractors must comply with Section 6002 of the Solid Waste Disposal Act, Public Law No. 89-272 (1965) (codified as amended by the Resource Conservation and Recovery Act at 42 U.S.C. § 6962).

The requirements of Section 6002 include procuring only items designated in guidelines of the Environmental Protection Agency (EPA) at 40 CFR part 247 that contain the highest percentage of recovered materials practicable, consistent with maintaining a satisfactory level of competition, where the purchase price of the item exceeds \$10,000 or the value of the quantity acquired during the preceding fiscal year exceeded \$10,000; procuring solid waste management services in a manner that maximizes energy and resource recovery; and establishing an affirmative procurement program for procurement of recovered materials identified in the EPA guidelines.

(b.) In the performance of this contract, the contractor shall make maximum use of products containing recovered materials that are EPA-designated items unless the product cannot be acquired:

- (1) Competitively within a timeframe providing for compliance with the contract performance schedule;
- (2) Meeting contract performance requirements; or
- (3) At a reasonable price.

(e) Information about this requirement is available at EPA's Comprehensive Procurement Guidelines website, <http://www.epa.gov/cpg/>. The list of EPA-designated items is available at <https://www.epa.gov/cpg/products.htm>.

In the event of any discrepancy between the provisions in this Section 63 of General Provisions and provisions on the same subject elsewhere within this procurement, the most stringent shall control.

70. SECTION 3 CLAUSE (§ 135.38) – HOUSING AND URBAN DEVELOPMENT (HUD)

**REQUEST FOR PROPOSAL
SEPTIC TANK SERVICES – RUNGE PARK
GALVESTON COUNTY, TEXAS**

SECTION 3 ACT OF 1968 (12 U.S.C. 1701u and 24 CFR Part 135)

DISCLAIMER: THIS CONTRACT [IS NOT] HUD-FUNDED AND THEREFORE SECTION 3 [DOES NOT] APPLY TO THIS CONTRACT.

For any HUD-funded contract with a value in excess of \$100,000, Contractor and subcontractors must comply with the Section 3 Act of 1968. The purpose of Section 3 is to ensure that employment and other economic opportunities generated by certain HUD financial assistance shall, to the greatest extent feasible, and consistent with existing Federal, State and local laws and regulations, be directed to low- and very low-income persons, particularly those who are recipients of government assistance for housing, and to business concerns which provide economic opportunities to low- and very low-income persons.

Section 3 is triggered when the normal completion of construction and rehabilitation projects creates the need for new employment, contracting, or training opportunities.

For any Section 3 Covered Contracts, Contractor and subcontractors must comply with all provisions of the Section 3 Act of 1968, contained under 24 CFR 135. Contractor and subcontractors must include the Section 3 Clause in its entirety, in every subcontract subject to compliance with regulations in 24 CFR 135.

Contractor and subcontractors must assure that to the greatest extent feasible, contracts for work to be performed in connection with the project are awarded to Section 3 Business Concerns. Contractor and subcontractors must post all new hire opportunities with the local Workforce Solutions Center and/or Work-in-Texas, in accordance with 24 CFR 135. The minimum numeric goals for Section 3 utilization are:

- 30 percent of total number of new hires are Section 3 Residents (i.e. 1 out of 3 new hires); 10 percent of all awarded construction contracts are awarded to Section 3 Business Concerns;
- 3 percent of all awarded non-construction contracts are awarded to Section 3 Business Concerns.

A. The work to be performed under this contract is subject to the requirements of section 3 of the Housing and Urban Development Act of 1968, as amended, 12 U.S.C. 1701u (section 3). The purpose of section 3 is to ensure that employment and other economic opportunities generated by HUD assistance or HUD-assisted projects covered by section 3, shall, to the greatest extent feasible, be directed to low- and very low-income persons, particularly persons who are recipients of HUD assistance for housing.

B. The parties to this contract agree to comply with HUD's regulations in 24 CFR part 135, which implement section 3. As evidenced by their execution of this contract, the parties to this contract certify that they are under no contractual or other impediment that would prevent them from complying with the part 135 regulations.

C. The contractor agrees to send to each labor organization or representative of workers with which the contractor has a collective bargaining agreement or other understanding, if any, a notice advising the labor organization or workers' representative of the contractor's commitments under this section 3 clause, and will post copies of the notice in conspicuous places at the work site where both employees and applicants for training and employment positions can see the notice. The notice shall describe the section 3 preference, shall set forth minimum number and job titles subject to hire, availability of apprenticeship and training positions, the qualifications for each; and the name and location of the person(s) taking applications for each of the positions; and the anticipated date the work shall begin.

D. The contractor agrees to include this section 3 clause in every subcontract subject to compliance with regulations in 24 CFR part 135, and agrees to take appropriate action, as provided in an applicable provision of the subcontract or in this section 3 clause, upon a finding that the subcontractor is in violation of the

**REQUEST FOR PROPOSAL
SEPTIC TANK SERVICES – RUNGE PARK
GALVESTON COUNTY, TEXAS**

regulations in 24 CFR part 135. The contractor will not subcontract with any subcontractor where the contractor has notice or knowledge that the subcontractor has been found in violation of the regulations in 24 CFR part 135.

E. The contractor will certify that any vacant employment positions, including training positions, that are filled (1) after the contractor is selected but before the contract is executed, and (2) with persons other than those to whom the regulations of 24 CFR part 135 require employment opportunities to be directed, were not filled to circumvent the contractor's obligations under 24 CFR part 135.

F. Noncompliance with HUD's regulations in 24 CFR part 135 may result in sanctions, termination of this contract for default, and debarment or suspension from future HUD assisted contracts.

G. With respect to work performed in connection with section 3 covered Indian housing assistance, section 7(b) of the Indian Self-Determination and Education Assistance Act (25 U.S.C. 450e) also applies to the work to be performed under this contract. Section 7(b) requires that to the greatest extent feasible (i) preference and opportunities for training and employment shall be given to Indians, and (ii) preference in the award of contracts and sub contracts shall be given to Indian organizations and Indian-owned Economic Enterprises. Parties to this contract that are subject to the provisions of section 3 and section 7(b) agree to comply with section 3 to the maximum extent feasible, but not in derogation of compliance with section

71. REQUIRED CONTRACT PROVISIONS

The Part 200 Uniform Requirements require that non-Federal entities' contracts contain the applicable provisions described in Appendix II to Part 200 — "Contract Provisions for Non-Federal Entity Contracts Under Federal Awards." Violations of law will be referred to the proper authority in the applicable jurisdiction. All Prime Contractors awarded contracts by Galveston County which are federally funded, in whole or in part, are required to comply with the provisions below. Additionally, Prime Contractors with Galveston County are required to include the provisions below in any contracts executed with subcontractors performing the scope of work and shall pass these requirements on to its subcontractors and third-party contractors, as applicable. In addition to other provisions required by the relevant Federal agency, State of Texas, or Galveston County, all contracts made by Galveston County under the Federal award shall contain provisions covering the following, as applicable.

ACCESS TO RECORDS & RECORD RETENTION (2 CFR 200.336)

Contractor must provide Galveston County, the State of Texas, the Texas General Land Office (GLO), the U.S. Department of Housing and Urban Development (HUD), the FEMA Administrator, the Inspectors General, the Comptroller General of the United States, or any of their pass-through entities or authorized representatives access to any books, documents, papers, and records of the Contractor and its subcontractors which are directly pertinent to this contract/project for the purposes of making/responding to audits, examinations, excerpts, and transcriptions. The right also includes timely and reasonable access to the Contractor's personnel for the purpose of interview and discussion related to such documents. Contractor must keep records within Galveston County or note in bid that records will be available within the boundaries of Galveston County to those representatives within twenty-four (24) hours of request by the County. Contractor must maintain all records pertaining to the project for seven (7) years after receiving final payment and after all other pending matters have been closed.

ACCESSIBILITY (24 CFR 570.614) & SECTION 504 (29 U.S.C. Section 794 and 24 CFR Parts 8-9)

Contractor shall comply with all federal, state and local laws and regulations which prohibit recipients of federal funding from discriminating against individuals with disabilities. Applicable laws and regulations with which Contractor shall comply shall include, but are not limited to, the following: Section 504 of the Rehabilitation Act of 1973 (29 U.S.C. Section 794) (24 CFR Parts 8-9); Title II of the Americans with Disabilities Act of 1990; the Architectural Barriers Act of 1968 (42 U.S.C. 4151-4157); the Uniform Federal Accessibility Standards (Appendix A to 24 CFR Part 40 and Appendix A to 41 CFR Part 101-19, subpart 101-19.6); the

**REQUEST FOR PROPOSAL
SEPTIC TANK SERVICES – RUNGE PARK
GALVESTON COUNTY, TEXAS**

Americans with Disabilities Act (42 U.S.C. 12131; 47 U.S.C. 155, 201, 218, and 225); Texas Administrative Code, Title 10, Chapter 60, Subchapter (B) the Texas Architectural Barriers Act (TABAA); the Architectural Barriers (AB) Rules; and the Texas Accessibility Standards (TAS).

BYRD ANTI-LOBBYING AGREEMENT (2 CFR 200 APPENDIX II (J) AND 24 CFR 570.303)

Pursuant to 31 U.S.C.A. § 1352 (2003), if at any time during the contract term funding to contract exceeds \$100,000.00, the Contractor shall file with the County the Federal Standard Form LLL titled “Disclosure Form to Report Lobbying.” Each tier certifies to the tier above that it will not and has not used Federal appropriated funds to pay any person or organization for influencing or attempting to influence an officer or employee of any agency, a member of Congress, officer or employee of Congress, or an employee of a member of Congress in connection with obtaining any Federal contract, grant or any other award covered by 31 U.S.C. 1352. Each tier must also disclose any lobbying with non-Federal funds that takes place in connection with obtaining any Federal award. Such disclosures are forwarded from tier to tier up to the non-federal award.

CIVIL RIGHTS ACT OF 1964 (Title VI 42 U.S.C. § 2000d)

Title VI of the Civil Rights Act of 1964, Section 109 of the Community Development Act of 1974, Section 504 of the Rehabilitation Act of 1973 (29 U.S.C. Section 794) (24 CFR Parts 8-9), and the Americans with Disabilities Act of 1990 (42 U.S.C. 12131; 47 U.S.C. 155, 201, 218, and 225), prohibits Contractors from excluding or denying individuals benefits or participation in this project on the basis of race, color, religion, national origin, sex, or disability. The provisions require that no person in the United States shall on the ground of race, color, religion, national origin, sex, or disability be excluded from participation in, be denied the benefits of, or be subjected to discrimination under any program or activity funded in whole or in part with community development funds made available pursuant to these Acts.

For purposes of this Part “program or activity” is defined as any function conducted by an identifiable administrative unit of the recipient, or private Contractor receiving community development funds or loans from the recipient. “Funded in whole or in part with community development funds” means that community development funds in any amount in the form of grants or proceeds from HUD guaranteed loans have been transferred by the recipient or a subrecipient to an identifiable administrative unit and disbursed in a program or activity. A Contractor may not, under any program or activity to which the regulations of this Part may apply directly or through contractual or other arrangements, on the grounds of race, color, national origin, or sex:

- a. Deny any facilities, services, financial aid or other benefits provided under the program or activity;
- b. Provide any facilities, services, financial aid or other benefits, which are different, or are provided in a different form from that provided to others under the program or activity;
- c. Subject to segregated or separate treatment in any facility in, or in any matter of process related to receipt of any service or benefit under the program or activity;
- d. Restrict in any way access to, or in the enjoyment of any advantage or privilege enjoyed by others in connection with facilities, services, financial aid or other benefits under the program or activity;
- e. Treat an individual differently from others in determining whether the individual satisfies any admission, enrollment, eligibility, membership, or other requirement or condition which the individual must meet in order to be provided any facilities, services or other benefit provided under the program or activity; and
- f. Deny an opportunity to participate in a program or activity as an employee.

CLEAN AIR ACT (2 CFR Appendix II to Part 200 (G))

Pursuant to 2 CFR Appendix II to Part 200 (G), if at any time during the contract term funding to contract exceeds \$150,000, the Contractor must comply with all provisions of the Clean Air Act (42 U.S.C. 85) and Section 308 of the

**REQUEST FOR PROPOSAL
SEPTIC TANK SERVICES – RUNGE PARK
GALVESTON COUNTY, TEXAS**

Federal Water Pollution Control Act (33 U.S.C. 1251-1387), as amended. Contractors securing a contract in excess of \$150,000.00 shall not expend such funds by making use of subcontracting with facilities included on the Environmental Protection Agency List of Violating Facilities as per Section 306 of the Clean Air Act, Section 508 of The Clean Water Act, Executive Order 11738, and Environmental Protection Agency Regulations 40 CFR. For any subcontractors under this contract receiving contracts in excess of \$150,000 Contractor is required to include a provision that requires compliance with all applicable standards, orders or regulations issued pursuant to the Clean Air Act (42 U.S.C. 85) and Section 308 Federal Water Pollution Control Act as amended (33 U.S.C. 1251-1387). Violations shall be reported to the Federal awarding agency and the Regional Office of the Environmental Protection Agency (EPA).

CONTRACT WORK HOURS AND SAFETY STANDARDS ACT (2 CFR Appendix II to Part 200 (E))

Pursuant to 2 CFR 200 Appendix II (E), if at any time during the contract term funding to contract exceeds \$100,000, the Contractor must comply with the Contract Work Hours and Safety Standards Act (40 U.S.C. 3701-3708). Where applicable, all contracts awarded in excess of \$100,000 that involve the employment of mechanics or laborers must include a provision for compliance with 40 U.S.C. 3702 and 3704, as supplemented by Department of Labor regulations (29 CFR Part 5). Under 40 U.S.C. 3702 of the Act, each contractor must be required to compute the wages of every mechanic and laborer on the basis of a standard work week of 40 hours. Work in excess of the standard work week is permissible provided that the worker is compensated at a rate of not less than one and a half times the basic rate of pay for all hours worked in excess of 40 hours in the work week. The requirements of 40 U.S.C. 3704 are applicable to construction work and provide that no laborer or mechanic must be required to work in surroundings or under working conditions which are unsanitary, hazardous or dangerous. These requirements do not apply to the purchases of supplies or materials or articles ordinarily available on the open market, or contracts for transportation or transmission of intelligence

- (1) Overtime Requirements – No contractor or subcontractor contracting for any part of the contract work which may require or involve the employment of laborers or mechanics shall require or permit any such laborer or mechanic in any workweek in which he or she is employed on such work to work in excess of forty hours in such workweek unless such laborer or mechanic receives compensation at a rate not less than one and one-half times the basic rate of pay for all hours worked in excess of forty hours in such workweek.
- (2) Violation: liability for unpaid wages; liquidated damages. In the event of any violation of the clause set forth in paragraph (1) of this section the contractor and any subcontractor responsible therefore shall be liable for the unpaid wages. In addition, such contractor and subcontractor shall be liable to the United States (in the case of work done under contract for the District of Columbia or a territory, to such District or to such territory), for liquidated damages. Such liquidated damages shall be computed with respect to each individual laborer or mechanic, including watchmen and guards, employed in violation of the clause set forth in paragraph (1) of this section, in the sum of \$10 for each calendar day on which such individual was required or permitted to work in excess of the standard workweek of forty hours without payment of the overtime wages required by the clause set forth in paragraph (1) of this section.
- (3) Withholding for unpaid wages and liquidated damages. The (write in the name of the Federal agency or the loan or grant recipient) shall upon its own action or upon written request of an authorized representative of the Department of Labor withhold or cause to be withheld, from any moneys payable on account of work performed by the contractor or subcontractor under any such contract or any other Federal contract with the same prime contractor, or any other federally-assisted contract subject to the Contract Work Hours and Safety Standards Act, which is held by the same prime contractor, such sums as may be determined to be necessary to satisfy any liabilities of such contractor or subcontractor for unpaid wages and liquidated damages as provided in the clause set forth in paragraph (2) of this section.

**REQUEST FOR PROPOSAL
SEPTIC TANK SERVICES – RUNGE PARK
GALVESTON COUNTY, TEXAS**

- (4) **Subcontracts.** The contractor or subcontractor shall insert in any subcontracts the clauses set forth in paragraph (1) through (4) of this section and also a clause requiring the subcontractors to include these clauses in any lower tier subcontracts. The prime contractor shall be responsible for compliance by any subcontractor or lower tier subcontractor with the clauses set forth in paragraphs (1) through (4) of this section.

COPELAND “ANTI-KICKBACK” ACT (40 U.S.C. 3145)

Pursuant to 2 CFR Appendix II to Part 200 (D), Contractor must comply with the provisions of the Copeland “Anti-Kickback” Act (40 U.S.C. 3145), as supplemented by Department of Labor regulations (29 CFR Part 3, “Contractors and Subcontractors on Public Building or Public Work Financed in Whole or in Part by Loans or Grants from the United States”). The Act provides that each vendor, contractor, subcontractor, or subrecipient shall be prohibited from inducing, by any means, any person employed in the construction, completion, or repair of public work, to give up any part of the compensation to which he or she is otherwise entitled. Contractor shall include this provision in all contracts between itself and any subcontractors in connection with the services performed under this Contract. Galveston County shall report all suspected or reported violations to the Federal awarding agency.

COST PLUS CONTRACTING PROHIBITED (2 CFR 200.323(D))

Cost-plus-a-percentage-of-cost (CPPC) contracts are prohibited by 2 CFR 200.323(d). The cost plus a percentage of cost and percentage of construction cost methods of contracting must never be used, including in subcontracts and third-party contracts. A cost-plus contract is one that is structured to pay the contractor or subcontractor their actual costs incurred, plus a fixed percent for profit or overhead.

A cost-plus-a-percentage-of-cost (CPPC) contract is a contract containing some element that obligates Galveston County or Contractor to pay a contractor or subcontractor an amount (in the form of either profit or cost), undetermined at the time the contract was made, to be incurred in the future, and based on a percentage of future costs. The inclusion of an overall contract ceiling price does not make these forms of contracts acceptable. This type of contract is prohibited because there is no incentive for the contractor or subcontractor to keep its incurred costs low. Instead, there is a reverse incentive for the contractor or subcontractor to continue to incur additional costs in order to continue to drive the percentage of cost up. In other words, increased spending by the contractor will yield higher profits. This prohibition applies to all work, regardless of the circumstances, and applies to subcontracts of the contractor cases where the prime contract is a cost-reimbursement type contract or subject to price redetermination.

DAVIS BACON AND RELATED ACTS (2 CFR 200 APPENDIX II (D))

Pursuant to 2 CFR 200 Appendix II (D), for any contract in excess of \$2,000, Contractor must comply with the Davis Bacon and Related Acts, and the requirements shall be applicable to any labor or mechanic work completed in connection with this contract which fall under the Davis Bacon Act. Any Contractor awarded under this contract is required to comply with the Davis Bacon Act (40 U.S.C. 3141-3144, and 3146-3148) as supplemented by Department of Labor regulations (29 CFR part 5) and with the Copeland “Anti-Kickback” Act (18 U.S.C. 874; 40 U.S.C. 3145) as supplemented in Department of Labor regulations (29 CFR part 3). In accordance with the statute, Contractors are required to pay wages to laborers and mechanics at a rate not less than the prevailing wages specified in a wage determination made by the Secretary of Labor. In addition, contractors must be required to pay wages not less than once a week.

If Davis Bacon is applicable, Galveston County will provide a copy of the current Davis Bacon Wage Decision with the solicitation. The decision to award a contract or subcontract shall be conditioned upon the acceptance of the wage determination. Contractor shall submit certified payroll of contractor and all subcontractors on a weekly basis in the format required by the County. At County’s request, Contractor shall make available and shall require its

**REQUEST FOR PROPOSAL
SEPTIC TANK SERVICES – RUNGE PARK
GALVESTON COUNTY, TEXAS**

subcontractors to make available, copies of cancelled checks and check stubs for comparisons by the County or its agents.

Such laborers and mechanics shall be paid the appropriate wage rate and fringe benefits on the wage determination for the classification of work actually performed, without regard to skill, except as provided in 29 CFR Part 5.5(a)(4). Laborers or mechanics performing work in more than one classification may be compensated at the rate specified for each classification for the time actually worked therein: Provided that the employer's payroll records accurately set forth the time spent in each classification in which work is performed. The wage determination (including any additional classification and wage rates conformed under 29 CFR Part 5.5(a)(1)(ii)) and the Davis Bacon poster (WH-1321) shall be posted at all times by the contractor and its subcontractors at the site of the work in a prominent and accessible place where it can be easily seen by the workers.

Each payroll submitted shall be accompanied by a "Statement of Compliance," signed by the contractor or subcontractor or his or her agent who pays or supervises the payment of the persons employed under the contract and shall certify the following. The Statement of Compliance can be found on page 2 of the WH-347 form, and/or additional certifications of compliance may be required by Galveston County. Any Statement of Compliance is subject to the penalties provided by 18 U.S.C. § 1001, namely, a fine, possible imprisonment of not more than 5 years, or both. Accordingly, the party signing the statement should have knowledge of the facts represented as true. Contractor must include this provision in all contracts between itself and any subcontractors in connection with the services performed under this Contract. Galveston County shall report all suspected or reported violations to the Federal awarding agency, as applicable.

DEBARMENT / SUSPENSION AND VOLUNTARY EXCLUSION (2 CFR Appendix II to Part 200 (I))

Pursuant to 2 CFR Appendix II to Part 200 (I), a Contract meeting the definition in 2 C.F.R. § 180.220 must not be made to parties listed on the System for Award Management (SAM) Exclusion lists, in accordance with the OMB guidelines at 2 CFR 180 that implement Executive Orders 12549 (3 CFR part 1986 Comp., p. 189) and 12689 (3 CFR part 1989 Comp., p. 235), "Debarment and Suspension." SAM Exclusions contains the names of parties debarred, suspended, or otherwise excluded by agencies, as well as parties declared ineligible under statutory or regulatory authority other than Executive Order 12549.

Pursuant to Executive Orders 12549 and 12689, a contract award shall not be made to parties listed on the government-wide exclusions in the System for Award Management (SAM), in accordance with the OMB guidelines at 2 CFR 180 that implement Executive Orders 12549 (3 CFR part 1986 Comp., p. 189) and 12689 (3 CFR part 1989 Comp., p. 235). SAM Exclusions contains the names of parties debarred, suspended, or otherwise excluded by agencies, as well as parties declared ineligible under statutory or regulatory authority other than Executive Order 12549. A contract award must not be made to parties listed in the SAM Exclusions. SAM exclusions can be accessed at www.sam.gov.

Additionally, no contracts shall be awarded to any Contractor that has been debarred, suspended, or otherwise excluded from or ineligible for participation in any federal programs, including but not limited to the Department of Health and Human Services (DHHS), Office of Inspector General (OIG) - List of Excluded Individuals & Entities (LEIE); U.S. General Services Administration (GSA) – Excluded Parties List System (EPLS); All States (50) Health & Human Services Commission Medicaid OIG Sanction List; Government Terrorist Watch List (OFAC / Patriot Act); Department of Commerce, Bureau of Industry and Security, Denied Persons List; and Department of Homeland Security, Immigration and Customs Enforcement (ICE) Most Wanted.

This contract is a covered transaction for purposes of compliance with Title 2 C.F.R. parts 180 and 3000, and as such the Contractor is required to verify that none of the contractor, its principals (as defined at 2 C.F.R. § 180.995), or its affiliates (as defined at 2 C.F.R. § 180.905) are excluded (as defined at 2 C.F.R. § 180.940) or disqualified (as defined at 2 C.F.R. § 180.935). These regulations restrict awards, subawards, and contracts with certain parties that are debarred, suspended, or otherwise excluded from or ineligible for participation in Federal assistance programs and activities (See 2 C.F.R Part 200, Appendix II). The Contractor must comply with 2 C.F.R. part 180, subpart C and 2

**REQUEST FOR PROPOSAL
SEPTIC TANK SERVICES – RUNGE PARK
GALVESTON COUNTY, TEXAS**

C.F.R. part 3000, subpart C and shall include this requirement and similar certification in all contracts between itself and any subcontractors in connection with the services performed under this Contract.

The Contractor confirms that it is eligible or otherwise not disqualified or prohibited from participation in federal or state assistance programs under Executive Order 12549, Debarment and Suspension. Additionally, the Contractor warrants that it is not debarred, suspended, or otherwise excluded from or ineligible for participation in any federal programs, including but not limited to the following: Department of Health and Human Work (DHHS), Office of Inspector General (OIG) - List of Excluded Individuals & Entities (LEIE); U.S. General Services Administration (GSA) – Excluded Parties List System (EPLS); All States (50) Health & Human Work Commission Medicaid OIG Sanction List; Government Terrorist Watch List (OFAC / Patriot Act); Department of Commerce, Bureau of Industry and Security, Denied Persons List; and Department of Homeland Security, Immigration and Customs Enforcement (ICE) Most Wanted. Galveston County reserves the right to verify any contractor's status and document instances of debarment, suspension, or other ineligibility.

Contractor shall verify that all subcontractors performing work under this Contract are not debarred, disqualified, or otherwise prohibited from participation in accordance with the requirements above. The Contractor further must notify Galveston County in writing immediately if Contractor or its subcontractors are not in compliance with Executive Order 12549 during the term of this contract. Contractor shall include this provision in all contracts between itself and any subcontractors in connection with the services performed under this Contract.

If it is found that the Contractor did not comply or is not in compliance with Executive Order 12549 (2 C.F.R. part 180, subpart C and 2 C.F.R. part 3000, subpart C), the Contractor may be subject to available remedies, including but not limited to, refunding Galveston County for any payments made to the Contractor while ineligible, and also acknowledges that the Federal Government may pursue available remedies, including but not limited to suspension and/or debarment.

EQUAL EMPLOYMENT OPPORTUNITY (41 CFR 60-1.4(b) and 2 CFR 200 APPENDIX II (C))

Contractor must comply with, and incorporate or cause to be incorporated into any contract for construction work, or modification thereof, the Equal Employment Opportunity provisions as follows:

During the performance of this contract, the contractor agrees as follows:

1. The contractor will not discriminate against any employee or applicant for employment because of race, color, religion, sex, sexual orientation, gender identity, or national origin. The contractor will take affirmative action to ensure that applicants are employed, and that employees are treated during employment without regard to their race, color, religion, sex, sexual orientation, gender identity, or national origin. Such action shall include, but not be limited to the following:

Employment, upgrading, demotion, or transfer; recruitment or recruitment advertising; layoff or termination; rates of pay or other forms of compensation; and selection for training, including apprenticeship. The contractor agrees to post in conspicuous places, available to employees and applicants for employment, notices to be provided setting forth the provisions of this nondiscrimination clause.

2. The contractor will, in all solicitations or advertisements for employees placed by or on behalf of the contractor, state that all qualified applicants will receive consideration for employment without regard to race, color, religion, sex, sexual orientation, gender identity, or national origin.
3. The contractor will not discharge or in any other manner discriminate against any employee or applicant for employment because such employee or applicant has inquired about, discussed, or disclosed the compensation of the employee or applicant or another employee or applicant. This provision shall not apply to instances in which an employee who has access to the compensation information of other employees or

**REQUEST FOR PROPOSAL
SEPTIC TANK SERVICES – RUNGE PARK
GALVESTON COUNTY, TEXAS**

applicants as a part of such employee's essential job functions discloses the compensation of such other employees or applicants to individuals who do not otherwise have access to such information, unless such disclosure is in response to a formal complaint or charge, in furtherance of an investigation, proceeding, hearing, or action, including an investigation conducted by the employer, or is consistent with the contractor's legal duty to furnish information.

4. The contractor will send to each labor union or representative of workers with which he has a collective bargaining agreement or other contract or understanding, a notice to be provided advising the said labor union or workers' representatives of the contractor's commitments under this section and shall post copies of the notice in conspicuous places available to employees and applicants for employment.
5. The contractor will comply with all provisions of Executive Order 11246 of September 24, 1965, and of the rules, regulations, and relevant orders of the Secretary of Labor.
6. The contractor will furnish all information and reports required by Executive Order 11246 of September 24, 1965, and by rules, regulations, and orders of the Secretary of Labor, or pursuant thereto, and will permit access to his books, records, and accounts by the administering agency and the Secretary of Labor for purposes of investigation to ascertain compliance with such rules, regulations, and orders.
7. In the event of the contractor's noncompliance with the nondiscrimination clauses of this contract or with any of the said rules, regulations, or orders, this contract may be canceled, terminated, or suspended in whole or in part and the contractor may be declared ineligible for further Government contracts or federally assisted construction contracts in accordance with procedures authorized in Executive Order 11246 of September 24, 1965, and such other sanctions may be imposed and remedies invoked as provided in Executive Order 11246 of September 24, 1965, or by rule, regulation, or order of the Secretary of Labor, or as otherwise provided by law.
8. The contractor will include the portion of the sentence immediately preceding paragraph (1) and the provisions of paragraphs (1) through (8) in every subcontract or purchase order unless exempted by rules, regulations, or orders of the Secretary of Labor issued pursuant to section 204 of Executive Order 11246 of September 24, 1965, so that such provisions will be binding upon each subcontractor or vendor. The contractor will take such action with respect to any subcontract or purchase order as the administering agency may direct as a means of enforcing such provisions, including sanctions for noncompliance:

Provided, however, that in the event a contractor becomes involved in, or is threatened with, litigation with a subcontractor or vendor as a result of such direction by the administering agency, the contractor may request the United States to enter into such litigation to protect the interests of the United States.

The Contractor further agrees that it will be bound by the above equal opportunity clause with respect to its own employment practices when it participates in federally assisted construction work: Provided, That if the applicant so participating is a State or local government, the above equal opportunity clause is not applicable to any agency, instrumentality or subdivision of such government which does not participate in work on or under the contract.

The Contractor agrees that it will assist and cooperate actively with the administering agency and the Secretary of Labor in obtaining the compliance of contractors and subcontractors with the equal opportunity clause and the rules, regulations, and relevant orders of the Secretary of Labor, that it will furnish the administering agency and the Secretary of Labor such information as they may require for the supervision of such compliance, and that it will otherwise assist the administering agency in the discharge of the agency's primary responsibility for securing compliance.

**REQUEST FOR PROPOSAL
SEPTIC TANK SERVICES – RUNGE PARK
GALVESTON COUNTY, TEXAS**

The Contractor further agrees that it will refrain from entering into any contract or contract modification subject to Executive Order 11246 of September 24, 1965, with a contractor debarred from, or who has not demonstrated eligibility for, Government contracts and federally assisted construction contracts pursuant to the Executive Order and will carry out such sanctions and penalties for violation of the equal opportunity clause as may be imposed upon contractors and subcontractors by the administering agency or the Secretary of Labor pursuant to Part II, Subpart D of the Executive Order. In addition, the Contractor agrees that if it fails or refuses to comply with these undertakings, the administering agency may take any or all of the following actions: Cancel, terminate, or suspend in whole or in part this grant (contract, loan, insurance, guarantee); refrain from extending any further assistance to the Contractor under the program with respect to which the failure or refund occurred until satisfactory assurance of future compliance has been received from such Contractor; and refer the case to the Department of Justice for appropriate legal proceedings. Contractor must include the equal opportunity clause in each of its nonexempt subcontracts, and to require all non-exempt subcontractors to include the equal opportunity clause in each of its nonexempt subcontracts.

EQUAL EMPLOYMENT OPPORTUNITY FOR WORKERS WITH DISABILITIES (48 CFR 52.22236)

During the performance of this contract, the Contractor must comply with required Equal Employment Opportunity for Workers with Disabilities provisions.

Contractor shall include the following equal opportunity clause in each of its covered Government contracts or subcontracts (and modifications, renewals, or extensions thereof if not included in the original contract):

- a. Equal opportunity clause. The Contractor shall abide by the requirements of the equal opportunity clause at 41 CFR 60-741.5(a), as of March 24, 2014. This clause prohibits discrimination against qualified individuals on the basis of disability and requires affirmative action by the Contractor to employ and advance in employment qualified individuals with disabilities.
- b. Subcontracts. The Contractor shall include the terms of this clause in every subcontract or purchase order in excess of \$15,000 unless exempted by rules, regulations, or orders of the Secretary, so that such provisions will be binding upon each subcontractor or vendor. The Contractor shall act as specified by the Director, Office of Federal Contract Compliance Programs of the U.S. Department of Labor, to enforce the terms, including action for noncompliance. Such necessary changes in language may be made as shall be appropriate to identify properly the parties and their undertakings.

EQUAL EMPLOYMENT OPPORTUNITY FOR VEVRAA PROTECTED VETERANS (41 CFR 60.300)

Galveston County is an equal opportunity employer of protected veterans. During the performance of this contract, the Contractor must comply with required Equal Employment Opportunity for VEVRAA Protected Veterans provisions. Contractor shall include the following equal opportunity clause in each of its covered Government contracts or subcontracts (and modifications, renewals, or extensions thereof if not included in the original contract):

- a. The definitions set forth in 41 CFR 60-300.2 apply to the terms used throughout this Clause, and they are incorporated herein by reference.
- b. The contractor shall not discriminate against any employee or applicant for employment because he or she is a disabled veteran, recently separated veteran, active-duty wartime or campaign badge veteran, or Armed Forces service medal veteran (hereinafter collectively referred to as “protected veteran(s)”) in regard to any position for which the employee or applicant for employment is qualified. The contractor agrees to take affirmative action to employ, advance in employment and otherwise treat qualified individuals without discrimination based on their status as a protected veteran in all employment practices, including the following:
 - i Recruitment, advertising, and job application procedures.

**REQUEST FOR PROPOSAL
SEPTIC TANK SERVICES – RUNGE PARK
GALVESTON COUNTY, TEXAS**

- ii Hiring, upgrading, promotion, award of tenure, demotion, transfer, layoff, termination, right of return from layoff and rehiring.
 - iii Rates of pay or any other form of compensation and changes in compensation.
 - iv Job assignments, job classifications, organizational structures, position descriptions, lines of progression, and seniority lists.
 - v Leaves of absence, sick leave, or any other leave.
 - vi Fringe benefits available by virtue of employment, whether or not administered by the contractor.
 - vii Selection and financial support for training, including apprenticeship, and on-the-job training under 38 U.S.C. 3687, professional meetings, conferences, and other related activities, and selection for leaves of absence to pursue training.
 - viii Activities sponsored by the contractor including social or recreational programs.
 - ix Any other term, condition, or privilege of employment.
- c. The contractor shall immediately list all employment openings which exist at the time of the execution of this contract and those which occur during the performance of this contract, including those not generated by this contract and including those occurring at an establishment of the contractor other than the one where the contract is being performed, but excluding those of independently operated corporate affiliates, with the appropriate employment service delivery system where the opening occurs. Listing employment openings with the state workforce agency job bank or with the local employment service delivery system where the opening occurs will satisfy the requirement to list jobs with the appropriate employment service delivery system. In order to satisfy the listing requirement described herein, contractors must provide information about the job vacancy in any manner and format permitted by the appropriate employment service delivery system which will allow that system to provide priority referral of veterans protected by VEVRAA for that job vacancy. Providing information on employment openings to a privately run job service or exchange will satisfy the contractor's listing obligation if the privately run job service or exchange provides the information to the appropriate employment service delivery system in any manner and format that the employment service delivery system permits which will allow that system to provide priority referral of protected veterans.
- d. Listing of employment openings with the appropriate employment service delivery system pursuant to this clause shall be made at least concurrently with the use of any other recruitment source or effort and shall involve the normal obligations which attach to the placing of a bona fide job order, including the acceptance of referrals of veterans and nonveterans. The listing of employment openings does not require the hiring of any particular job applicants or from any particular group of job applicants, and nothing herein is intended to relieve the contractor from any requirements in Executive orders or regulations regarding nondiscrimination in employment.
- e. Whenever a contractor, other than a state or local governmental contractor, becomes contractually bound to the listing provisions in paragraphs 2 and 3 of this clause, it shall advise the employment service delivery system in each state where it has establishments that: (a) It is a Federal contractor, so that the employment service delivery systems are able to identify them as such; and (b) it desires priority referrals

**REQUEST FOR PROPOSAL
SEPTIC TANK SERVICES – RUNGE PARK
GALVESTON COUNTY, TEXAS**

from the state of protected veterans for job openings at all locations within the state. The contractor shall also provide to the employment service delivery system the name and location of each hiring location within the state and the contact information for the contractor official responsible for hiring at each location. The “contractor official” may be a chief hiring official, a Human Resources contact, a senior management contact, or any other manager for the contractor that can verify the information set forth in the job listing and receive priority referrals from employment service delivery systems. In the event that the contractor uses any external job search organizations to assist in its hiring, the contractor shall also provide to the employment service delivery system the contact information for the job search organization(s). The disclosures required by this paragraph shall be made simultaneously with the contractor's first job listing at each employment service delivery system location after the effective date of this final rule. Should any of the information in the disclosures change since it was last reported to the employment service delivery system location, the contractor shall provide updated information simultaneously with its next job listing. As long as the contractor is contractually bound to these provisions and has so advised the employment service delivery system, there is no need to advise the employment service delivery system of subsequent contracts. The contractor may advise the employment service delivery system when it is no longer bound by this contract clause.

- f. The provisions of paragraphs 2 and 3 of this clause do not apply to the listing of employment openings which occur and are filled outside of the 50 states, the District of Columbia, the Commonwealth of Puerto Rico, Guam, the Virgin Islands, American Samoa, the Commonwealth of the Northern Mariana Islands, Wake Island, and the Trust Territories of the Pacific Islands.
- g. As used in this clause:
 - i. All employment openings include all positions except executive and senior management, those positions that will be filled from within the contractor's organization, and positions lasting three days or less. This term includes full-time employment, temporary employment of more than three days' duration, and part-time employment.
 - ii. Executive and senior management means: (1) Any employee (a) compensated on a salary basis at a rate of not less than \$455 per week (or \$380 per week, if employed in American Samoa by employers other than the Federal Government), exclusive of board, lodging or other facilities; (b) whose primary duty is management of the enterprise in which the employee is employed or of a customarily recognized department or subdivision thereof; (c) who customarily and regularly directs the work of two or more other employees; and (d) who has the authority to hire or fire other employees or whose suggestions and recommendations as to the hiring, firing, advancement, promotion or any other change of status of other employees are given particular weight; or (2) any employee who owns at least a bona fide 20-percent equity interest in the enterprise in which the employee is employed, regardless of whether the business is a corporate or other type of organization, and who is actively engaged in its management.
 - iii. Positions that will be filled from within the contractor's organization means employment openings for which no consideration will be given to persons outside the contractor's organization (including any affiliates, subsidiaries, and parent companies) and includes any openings which the contractor proposes to fill from regularly established “recall” lists. The exception does not apply to a particular opening once an employer decides to consider applicants outside of his or her own organization.

**REQUEST FOR PROPOSAL
SEPTIC TANK SERVICES – RUNGE PARK
GALVESTON COUNTY, TEXAS**

- h. The contractor shall comply with the rules, regulations, and relevant orders of the Secretary of Labor issued pursuant to the Act.
- i. In the event of the contractor's noncompliance with the requirements of this clause, actions for noncompliance may be taken in accordance with the rules, regulations, and relevant orders of the Secretary of Labor issued pursuant to the Act.
- j. The contractor agrees to post in conspicuous places, available to employees and applicants for employment, notices in a form to be prescribed by the Director, Office of Federal Contract Compliance Programs, provided by or through the contracting officer. Such notices shall state the rights of applicants and employees as well as the contractor's obligation under the law to take affirmative action to employ and advance in employment qualified employees and applicants who are protected veterans. The contractor must ensure that applicants or employees who are disabled veterans are provided the notice in a form that is accessible and understandable to the disabled veteran (e.g., providing Braille or large print versions of the notice, posting the notice for visual accessibility to persons in wheelchairs, providing the notice electronically or on computer disc, or other versions). With respect to employees who do not work at a physical location of the contractor, a contractor will satisfy its posting obligations by posting such notices in an electronic format, provided that the contractor provides computers that can access the electronic posting to such employees, or the contractor has actual knowledge that such employees otherwise are able to access the electronically posted notices. Electronic notices for employees must be posted in a conspicuous location and format on the company's intranet or sent by electronic mail to employees. An electronic posting must be used by the contractor to notify job applicants of their rights if the contractor utilizes an electronic application process. Such electronic applicant notice must be conspicuously stored with, or as part of, the electronic application.
- k. The contractor will notify each labor organization or representative of workers with which it has a collective bargaining agreement or other contract understanding that the contractor is bound by the terms of VEVRAA and is committed to take affirmative action to employ and advance in employment, and shall not discriminate against, protected veterans.
- l. The contractor will include the provisions of this clause in every subcontract or purchase order of \$100,000 or more, unless exempted by the rules, regulations, or orders of the Secretary issued pursuant to VEVRAA so that such provisions will be binding upon each subcontractor or vendor. The contractor will take such action with respect to any subcontract or purchase order as the Director, Office of Federal Contract Compliance Programs, may direct to enforce such provisions, including action for noncompliance.
- m. The contractor must, in all solicitations or advertisements for employees placed by or on behalf of the contractor, state that all qualified applicants will receive consideration for employment without regard to their protected veteran status.
- n. The Contractor shall forfeit as a penalty to the County who administers the subject Project receiving Federal assistance, Sixty Dollars (\$60.00) for each worker, employed for each calendar day, or a portion thereof, such worker is paid less than the said stipulated rates for any work done under this Project, by him/her or by any contractor under him/her.
- o. All contractors shall keep, or cause to be kept, an accurate record showing the names of all workers, also the actual per diem wages paid to each of such workers.

**REQUEST FOR PROPOSAL
SEPTIC TANK SERVICES – RUNGE PARK
GALVESTON COUNTY, TEXAS**

FAIR LABOR STANDARDS ACT

Contractor must comply the Fair Labor Standards Act of 1938 (29 U.S.C. Section 201 et seq.) as now or hereafter amended, which regulates wage, hour and other employment practices that govern the use of funds provided and the employment of personnel under this contract. The Contractor warrants that it will pay all its workers all monies earned by its workers including, but not limited to regular wages, any overtime compensation, or any additional payments pursuant to the Fair Labor Standards Act, 29 United States Code (U.S.C.) Section 207 9a(1), as amended; the Texas Pay Day Act; the Equal Pay Act; Title VII of the Civil Rights Act of 1964, 42 U.S.C. Section 2000, et al., as amended; or any provisions of the Texas Labor Code Ann., as amended.

FLOOD DISASTER PROTECTION ACT OF 1973 (24 CFR 570.605)

Contractor must comply with the provisions in 24 CFR 570.605, Section 202(a) of the Flood Disaster Protection Act of 1973 (42 U.S.C. 4106), and the regulations in 44 CFR Parts 59-79.

GREEN BUILDING STANDARDS

At a minimum, Contractors and subcontractors must comply with local codes and any applicable national building codes for any work involving rehabilitation or construction, including design. When a contract is funded, in whole or in part, by HUD funding, Contractors must comply with applicable Green Building standards to the maximum extent feasible. Green Building standards may apply to single-family properties, multifamily properties, or both and may include, but are not limited to best practices defined under LEED, Enterprise Green Communities, or NAHB National Green Building Standards and may include specific measures for water conservation, energy efficiency, and indoor air quality. Contractor and subcontractors must comply with the following standards, as applicable:

- 2009 ICC International Energy Conservation Code (IECC)
- ASHRAE 90.1-2007, which sets minimum energy standards for buildings except low-rise residential buildings
- ASHRAE 62.1-2010 and 62.2-2010, which set minimum standards for ventilation for indoor air quality for common areas in mid- and high-rise buildings, and low-rise residential buildings, respectively.
- New or replacement residential housing, when funded by CDBG-DR grants, must adhere to Green Building standards, including Energy Star Certified Homes or Energy Star for Multifamily High Rise and other applicable green building requirements.
- Moderate residential housing rehabilitation, when funded by CDBG-DR grants, must comply with the Community Planning & Development (CPD) Retrofit Checklist and provide Energy Star appliances, Water Sense or FEMP products if replaced.
- New or replacement residential housing, when funded by CDBG-DR grants, must adhere to Green Building standards, including Energy Star Certified Homes or Energy Star for Multifamily High Rise and other applicable green building requirements.

HOLD HARMLESS AGREEMENT

Contractor shall indemnify, defend, and hold harmless Galveston County from all claims for personal injury, death and/or property damage resulting directly or indirectly from contractor's performance. Contractor shall procure and maintain, with respect to the subject matter of this Request for Proposals, appropriate insurance coverage including, at a minimum, public liability and property damage with adequate limits to cover contractor's liability as may arise directly or indirectly from work performed under terms of this Request for Proposals. Certification of such coverage must be provided to the County upon request.

**REQUEST FOR PROPOSAL
SEPTIC TANK SERVICES – RUNGE PARK
GALVESTON COUNTY, TEXAS**

The Federal Government is not a party to this contract and is not subject to any obligations or liabilities to the non-Federal entity, contractor, or any other party pertaining to any matter resulting from the contract.

LEAD-BASED PAINT (24 CFR 570.608)

Contractor and subcontractors must comply with the provisions found in 24 CFR 570.608, the Lead-Based Paint Poisoning Prevention Act (42 U.S.C. 4821-4846), the Residential Lead Based Paint Hazard Reduction Act of 1992 (U.S.C. 4851-4856, and 24 CFR Part 35, subparts A, B, J, K, and R. This Article 2(f) is to be included in all subcontracts, for work in connection with this Contract, which relate to residential structures.

NON-COLLUSION (The Sherman Act)

Contractor must comply with the requirements of The Sherman Act, which prohibit collusion. Collusion occurs when two persons or representatives of an entity or organization make an agreement to deceive or mislead another. Such agreements are usually secretive and involve fraud or gaining an unfair advantage over a third party, competitors, consumers or others with whom they are negotiating. The collusion, therefore, makes the bargaining process inherently unfair. Collusion can involve promises of future benefits, price or wage fixing, kickbacks, or misrepresenting the independence of the relationship between the colluding parties.

The Sherman Act prohibits any agreement among competitors to fix prices, rig bids, or engage in other anticompetitive activity. Collusion, bid rigging, or other anticompetitive activity is considered a felony. Contractor shall not in any way, directly or indirectly:

- a. Collude, conspire, or agree with any other person, firm, corporation, Proposer or potential Proposer to the amount of this Bid or the terms or conditions of this Bid.
- b. Pay or agree to pay any other person, firm, corporation Proposer or potential Proposer any money or anything of value in return for assistance in procuring or attempting to procure a contract or in return for establishing the prices in the attached Bid or the Bid of any other Proposer.
- c. Assemble in coordination with any other organization in an attempt to fix the price of the work.

Contractors are expected to report any suspected fraud, collusion, or impropriety from the inception of solicitation through the end of the contract term.

NON-SEGREGATED FACILITIES

“Prohibition of Segregated Facilities”

- a. Segregated facilities means any waiting rooms, work areas, rest rooms and wash rooms, restaurants and other eating areas, time clocks, locker rooms and other storage or dressing areas, parking lots, drinking fountains, recreation or entertainment areas, transportation, and housing facilities provided for employees, that are segregated by explicit directive or are in fact segregated on the basis of race, color, religion, sex, sexual orientation, gender identity, or national origin because of written or oral policies or employee custom. The term does not include separate or single-user rest rooms or necessary dressing or sleeping areas provided to assure privacy between the sexes.

Sexual orientation has the meaning given by the Department of Labor's Office of Federal Contract Compliance Programs and is found at www.dol.gov/ofccp/LGBT/LGBT_FAQs.html.

- b. The Contractor agrees that it does not and will not maintain or provide for its employees any segregated facilities at any of its establishments, and that it does not and will not permit its employees to perform their services at any

**REQUEST FOR PROPOSAL
SEPTIC TANK SERVICES – RUNGE PARK
GALVESTON COUNTY, TEXAS**

location under its control where segregated facilities are maintained. The Contractor agrees that a breach of this clause is a violation of the Equal Opportunity clause in this contract.

- c. The Contractor shall include this clause in every subcontract and purchase order that is subject to the Equal Opportunity clause of this contract.

PARTICIPATION BY MINORITY & WOMEN-OWNED BUSINESS ENTERPRISES (2 CFR 200.321)

Contractor must comply with the Minority and Women-owned Business Enterprise participation requirements under 2 CFR 200.321. Contractors must take all affirmative steps necessary to subcontract with Minority and Women-owned Business Enterprises (MWBES) to assure that MWBES are used when possible. These affirmative steps shall include:

- A. Placing qualified small and minority businesses and women's business enterprises on solicitation lists;
- B. Assuring that small and minority businesses, and women's business enterprises are solicited whenever they are potential sources;
- C. Dividing total requirements, when economically feasible, into smaller tasks or quantities to permit maximum participation by small and minority businesses, and women's business enterprises;
- D. Establishing delivery schedules, where the requirement permits, which encourage participation by small and minority businesses, and women's business enterprises; and
- E. Using the services and assistance, as appropriate, of such organizations as the Small Business Administration and the Minority Business Development Agency of the Department of Commerce.

The State of Texas maintains a Historically Underutilized Business Program, which identifies any business at least 51 percent owned by an Asian Pacific American, Black American, Hispanic American, Native American, American woman and/or Service-Disabled Veteran, who resides in Texas and actively participate in the control, operations and management of the entity's affairs as a Historically Underutilized Business (also considered MWBE). Contractors who wish to check the status of a firm may visit <https://comptroller.texas.gov/purchasing/vendor/hub/>.

Contractors and subcontractors are required to facilitate Minority & Women-Owned Business Enterprise participation. Contractors are encouraged to utilize MWBES / HUB firms as subcontractors, subconsultants, or suppliers in order to comply with the requirements and may check for firms who perform relevant work by searching <https://comptroller.texas.gov/purchasing/vendor/hub/>.

Contractor and subcontractors must facilitate Minority & Women-Owned Business Enterprise participation and take all affirmative steps to utilize MWBES / HUB firms as subcontractors, subconsultants, or suppliers throughout the life of the Contract.

POTENTIAL CONFLICTS OF INTEREST

Pursuant to 2 CFR 200.112, Contractor must comply with disclosure requirements in accordance with Texas Local Government Code, Chapter 176. Contractor shall not use funds to directly or indirectly pay any person for influencing or attempting to influence any public employee or official in connection with the awarding of any contract or the extension, continuation, renewal, amendment or modification of any contract. By law, the Conflict of Interest Questionnaire (provided by the Texas Ethics Commission at www.ethics.state.tx.us) must be filed with the records administrator of the local governmental entity not later than the 7th business day after the date the Contractor becomes aware of facts that require the statement to be filed.

**REQUEST FOR PROPOSAL
SEPTIC TANK SERVICES – RUNGE PARK
GALVESTON COUNTY, TEXAS**

This law requires persons desiring to do business with the County to disclose any gifts valued in excess of \$250 given to any County Official or the County Official's family member, or employment of any County Official or the County Official's family member during the preceding twelve (12) month period. The disclosure questionnaire must be filed with the Galveston County Clerk. Refer to Texas Local Government Code, Chapter 176 for the details of this law.

An outside consultant or contractor is prohibited from submitting a bid for services on a Galveston County project of which the consultant or contractor was a designer or other previous contributor, or was an affiliate, subsidiary, joint venture or was in any other manner associated by ownership to any party that was a designer or other previous contributor. If such a consultant or contractor submits a prohibited bid, that bid shall be disqualified on the basis of conflict of interest, no matter when the conflict is discovered by Galveston County.

PREVAILING WAGES (2 CFR 200 APPENDIX II (D) and TGC 2258)

Pursuant to 2 CFR 200 Appendix II (D), Contractor must comply with Texas Government Code (TGC) 2258, Prevailing Wage Rates. Accordingly, Contractor must submit a certified payroll records as required, and compensate any worker employed on a public works project not less than as applicable. As noted under "Davis Bacon and Related Acts", when required by Federal program legislation, construction contracts in excess of \$2,000 awarded by Galveston County shall require compliance with the Davis-Bacon Act (40 U.S.C. 3141-3144, and 3146-3148) as supplemented by Department of Labor regulations (29 CFR Part 5, "Labor Standards Provisions Applicable to Contracts Covering Federally Financed and Assisted Construction"). In accordance with the statute, Contractor must pay wages to laborers and mechanics at a rate not less than the local prevailing wages, or Davis Bacon wages, as applicable. If both Texas prevailing wages and Davis Bacon provide rates for a particular class, Contractors must pay the greater wage rate. In addition, Contractor must pay wages not less than once a week.

In compliance with Section 2258 of the Texas Government Code, Contractor and any subcontractor hired by Contractor for the construction of any project, shall pay not less than the rates set forth in the Schedule of Prevailing Wages attached and incorporated by reference. In submitting a Bid, Contractor warrants that it and its subcontractors shall comply with all requirements and worker ratios per the applicable Schedule of Prevailing Wages and Texas state law.

Contractor must submit certified payroll of contractor and all subcontractors on a weekly basis. At County's request, Contractor must make available and shall require its subcontractors to make available, copies of cancelled checks and check stubs for comparisons by the County or its agents. Regardless of whether Davis Bacon or Texas Prevailing Wages apply, the County reserves the right for its agents to visit the project site and to interview contractor, its subcontractors and employees of each on any date or time, as often as desired during the construction period, without prior notification.

Galveston County will ascertain if proper wage rates are being paid to the employees as required. In the event of a discrepancy between the work performed and the wages paid, the County shall document same and notify Contractor. If, for any length of time and as determined by Galveston County, discrepancies appear between the certified payrolls and the actual wage paid, the County shall require check stubs to be attached to each weekly certified payroll. Pursuant to Texas Government Code Section 2258.051, the County reserves the right to withhold any monies due Contractor until such discrepancy is resolved and the necessary adjustment made. The Contractor shall forfeit as a penalty, in accordance with Texas Government Code Section 2258.023(b), to the County or entity who administers the subject Project receiving Federal assistance, Sixty Dollars (\$60.00) for each worker, employed for each calendar day, or a portion thereof, such worker is paid less than the said stipulated rates for any work done under this Project, by him/her or by any contractor/subcontractor under him/her.

**REQUEST FOR PROPOSAL
SEPTIC TANK SERVICES – RUNGE PARK
GALVESTON COUNTY, TEXAS**

All contractor/subcontractor shall keep, or cause to be kept, an accurate record showing the names of all workers, also the actual per diem wages paid to each of such workers. Contractor shall impose these same obligations upon its Subcontractors. Contractor understands that with weekly or monthly certified payrolls, contractor is responsible for any and all penalties that shall accrue during the month, regardless of the fact that any error could not be discovered by the Contract Compliance Officer until the following certified payroll.

PROCUREMENT OF RECOVERED MATERIALS (2 CFR 200.322)

Pursuant to 2 CFR 200.322, Contractor must comply with Section 6002 of the Solid Waste Disposal Act, Pub. L. No. 89-272 (1965) (codified as amended by the Resource Conservation and Recovery Act at 42 U.S.C. § 6962). As such, any contractors awarded under this contract opportunity is subject to the requirements of Section 6002, which include procuring only items designated in guidelines of the EPA at 40 C.F.R. Part 247 that contain the highest percentage of recovered materials practicable, consistent with maintaining a satisfactory level of competition, where the purchase price of the item exceeds \$10,000 or the value of the quantity acquired by the preceding fiscal year exceeded \$10,000; procuring solid waste management services in a manner that maximizes energy and resource recovery; and establishing an affirmative procurement program for procurement of recovered materials identified in the EPA guidelines.

PROGRAM FRAUD AND FALSE OR FRAUDULENT STATEMENTS OR RELATED ACTS

Contractor must comply with 31 U.S.C. Chapter 38, Administrative Remedies for False Claims and Statements, which shall apply to the activities and actions of the Contractor and its subcontractors pertaining to any matter resulting from the contract.

RESTRICTIONS ON PUBLIC BUILDINGS AND PUBLIC WORKS PROJECTS CERTIFICATION

- b. Definitions. The definitions pertaining to this provision are those that are set forth on the clause entitled “Restrictions on Public Works Projects.” (Set out under “Contract Clauses” below.)
- c. Certification. Except as provided in paragraph (C) of this provision, by submission of its bid or proposal, Proposer certifies that it:
 - i. Is not a Contractor of a foreign country included on the list of countries that discriminate against U.S. firms published by the Office of the United States Trade Representative (USTR) (see paragraph (H) of this provision);
 - ii. Has not or will not enter into any subcontract with a subcontractor of a foreign country included on the list of countries that discriminate against U.S. firms published by the USTR, and
 - iii. Will not provide any product of a country included on the list of foreign countries that discriminate against the U.S. firms published by the USTR.
- d. Inability to certify. A Proposer unable to certify in accordance with paragraph (b) of this provision shall submit with its offer a written explanation fully describing the reasons for its inability to make the certification.
- e. Applicability of 18 U.S.C. 1001. This certification is paragraph (B) of this provision concerns a matter within the jurisdiction of an agency of the United States, and the making of a false, fictitious, or fraudulent certification may render the maker subject to prosecution under Title 18 U.S.C. 1001.

**REQUEST FOR PROPOSAL
SEPTIC TANK SERVICES – RUNGE PARK
GALVESTON COUNTY, TEXAS**

- f. Notice. Proposer shall provide written notice to the Contracting Officer if, at any time before the contract award, Proposer learns that its certification was erroneous when submitted or has become erroneous by reason of changed circumstances.
- g. Restrictions on contract award. Unless a waiver to these restrictions is granted by the Secretary of Housing and Urban Development, no contract will be awarded to a Proposer (1) who is owned or controlled by a citizen or national of a foreign country included on the list of foreign countries that discriminate against U.S. firms published by the USTR, (2) whose subcontractors are owned or controlled by citizens or national of a foreign country on the USTR list or, (3) who incorporates any product of a foreign country on the USTR list in the public works project.
- h. USTR List. The USTR published an initial list in the Federal Register on December 30, 1987 (53 FR 49244), which identified one country-Japan. The USTR can add countries to the list, and remove countries from it, in accordance with section 109 (C) of PUB. L. 100-202.
- i.

RESTRICTIONS ON PUBLIC BUILDINGS AND PUBLIC WORKS PROJECTS

- a. Definitions. “Component”, as used in this clause, means those articles, materials, and supplies incorporated directly into the product. “Contractor or subcontractor of a foreign country,” as used in this clause, means any Contractor or subcontractor that is a citizen or national of a foreign country or is controlled directly or indirectly by citizens or nationals of a foreign country. A contractor or subcontractor shall be considered to be a citizen or national of a foreign country, or controlled directly or indirectly by citizens or nationals of a foreign country:
 - i. If 50 percent or more of the Contractor or subcontractor is owned by a citizen or a national of the foreign country;
 - ii. If the title to 50 percent or more of the stock of the Contractor or subcontractor is held subject to trust or fiduciary obligation in favor of citizens or nationals of the foreign country.
 - iii. If 50 percent or more of the voting power in the Contractor or subcontractor is vested in or exercisable on behalf of a citizen or national of the foreign country; iv. In the case of a partnership, if any general partner is a citizen of the foreign country;
 - v. In the case of a corporation. If its presidents or other chief executive officer or the chairman of its board of directors is a citizen of the foreign country or the majority of any number of its directors necessary to constitute a quorum are citizens of the foreign country or the corporation is organized under the laws of the foreign country or any subdivision, territory, or possession thereof; or
 - vi. In case of a contractor or subcontractor who is a joint venture, if any participant firm is a citizen or national of a foreign country or meets any of the criteria in subparagraphs (A) 1 through 5 of this clause. “Product”, as used in this clause, means construction materials, i.e. articles, materials and supplies brought to the construction site for incorporation into the public works project, including permanently affixed equipment, instruments, utilities, electronic or other devices, but not including vehicles or construction equipment. In determining the origin of a product, Galveston County will

**REQUEST FOR PROPOSAL
SEPTIC TANK SERVICES – RUNGE PARK
GALVESTON COUNTY, TEXAS**

consider a product as produce in a foreign country id it has been assembled or manufactured in the foreign country, or if the cost of the components mined, produced, or manufactured in the foreign country exceed 50 percent of the cost of all its components.

- b. Restrictions. The Contractor shall not (1) knowingly enter into any subcontract under this contract with a subcontractor of a foreign country included on the list of countries that discriminate against U.S. firms published by the United States Trade Representative (see paragraph (C) of this clause, or (2) supply any product under this contract of a country included on the list of foreign countries that discriminate against U.S. firms published by the USTR.
- c. USTR List. The USTR published an initial list in the Federal Register on December 30, 1987 (53 FR 49244), which identified one country-Japan. The USTR can add other countries to the list, or remove countries from it, in accordance with section 109 (C) of PUB. L. 100-102.
- d. Certification. The Contractor may rely upon the certification of a prospective subcontractor that it is not a subcontractor of a foreign country included on the list of countries that discriminate against U.S. firms published by the USTR and that products supplied by such subcontractor for use on the Federal public works project under this contract are not products of a foreign country included on the list of foreign countries that discriminate against U.S. firms published by the USTR, unless such Contractor has knowledge that the certification is erroneous.
- e. Subcontractors. The Contractor shall incorporate this clause, modified only for the purpose of properly identifying the parties, in all subcontracts. This paragraph (E) shall also be incorporated in all subcontracts.

RIGHTS TO INVENTIONS (2 CFR Appendix II to Part 200 (F))

Any discovery or invention that arises during the course of the contract shall be reported to Galveston County. This clause requires the Contractor to disclose promptly inventions to the County (within 2 months) after the inventor discloses it in writing to Contractor personnel responsible for patent matters. The awarding agency shall determine how rights in the invention/discovery shall be allocated consistent with "Government Patent Policy" and Title 37 C.F.R. § 401.

If the Federal award meets the definition of "funding agreement" under 37 C.F.R. §.401.2(a) and the recipient or subrecipient wishes to enter into a contract with a small business firm or nonprofit organization regarding the substitution of parties, assignment or performance of experimental, developmental, or research work under that "funding agreement," the recipient or subrecipient must comply with the requirements of Title 37 C.F.R. § 401, "Rights to Inventions Made by Nonprofit Organizations and Small Business Firms Under Government Grants, Contracts and Cooperative Agreements," and any implementing regulations issued by the awarding agency.

SECTION 109 OF THE HOUSING AND COMMUNITY DEVELOPMENT ACT OF 1974 (24 CFR 570.602)

Section 109 of the Act requires that no person in the United States shall on the grounds of race, color, national origin, religion, or sex be excluded from participation in, be denied the benefits of, or be subjected to discrimination under any program or activity receiving Federal financial assistance made available pursuant to the Act. Section 109 also directs that the prohibitions against discrimination on the basis of age under the Age Discrimination Act and the prohibitions against discrimination on the basis of disability under Section 504 shall apply to programs or activities receiving Federal financial assistance under Title I programs. The policies and procedures necessary to ensure enforcement of section 109 are codified in 24 CFR part 6.

**REQUEST FOR PROPOSAL
SEPTIC TANK SERVICES – RUNGE PARK
GALVESTON COUNTY, TEXAS**

TERMINATION FOR CAUSE & CONVENIENCE (2 CFR Appendix II to Part 200 (A) and (B))

Pursuant to 2 CFR Appendix II to Part 200 (A), Contracts for more than the simplified acquisition threshold currently set at \$150,000, which is the inflation adjusted amount determined by the Civilian Agency Acquisition Council and the Defense Acquisition Regulations Council (Councils) as authorized by 41 U.S.C. 1908, shall address administrative, contractual, or legal remedies in instances where contractors violate or breach contract terms, and provide for such sanctions and penalties as appropriate.

Pursuant to 2 CFR Appendix II to Part 200 (B), all contracts in excess of \$10,000 shall address termination for cause and for convenience by the non-Federal entity including the manner by which it will be affected and the basis for settlement. Galveston County shall have the right to terminate this contract for cause and convenience.

In the event of a failure by Contractor to satisfactorily perform the services specified herein and/or a default by Contractor in abiding by the other terms and conditions of this Contract, Galveston County may terminate the Contract on written notice to Contractor and Contractor shall be liable for all damages, costs, and expenses (including attorney fees) incurred by County related to this default. Such termination is in addition to and not in lieu of any other remedies that Galveston County may have in law or equity. Administrative remedies for nonperformance, violation or breach of contract terms, or termination of contract for default may include suspension and debarment. Galveston County may assess liquidated damages for failure to meet completion deadlines, contract breaches, or performance failures of the Contractor or its Subcontractors.

Contractor shall be provided the opportunity to cure certain performance failures or instances of default as described in the contract documents. The legal dispute resolution process as applicable under the Texas Civil Practice and Remedies Code shall include, but is not limited to, Texas and Civil Practice and Remedies Section 38 – Attorney’s Fees, Texas Civil Practice and Remedies Section 41 – Damages, and Texas Civil Practice and Remedies Section 154 – General Provisions. Galveston County and Contractor(s) should attempt to resolve any claim for breach of contract made by Contractor, to the extent it is applicable to the Contract and not preempted by other law. Except as otherwise provided by law, nothing herein is a waiver by the County or the State of Texas of the right to seek redress in a court of law.

Termination provisions are included in the Contract Requirements & Payment, Section VIII, portion of this IFB.

WHISTLEBLOWER PROTECTION ACT

Contractor, subcontractors, and employees working on this Project shall be subject 41 U.S. Code § 4712, which requires that an employee of a contractor, subcontractor, grantee, or subgrantee or personal services contractor may not be discharged, demoted, or otherwise discriminated against as a reprisal for disclosing information that the employee reasonably believes is evidence of gross mismanagement of a Federal contract or grant, a gross waste of Federal funds, an abuse of authority relating to a Federal contract or grant, a substantial and specific danger to public health or safety, or a violation of law, rule, or regulation related to a Federal contract (including the competition for or negotiation of a contract) or grant.

The Contractor shall inform its employees and subcontractors in writing, in the predominant language of the workforce, of employee whistleblower rights and protections under 41 U.S.C. 4712, as described in section 3.908 of the Federal Acquisition Regulation. The Contractor shall insert the substance of this clause, including this paragraph, in all subcontracts providing services for this Project.

72. NON-EXCLUSIVE LIST OF APPLICABLE LAWS, RULES, AND REGULATIONS – TEXAS GENERAL LAND OFFICE (GLO)

If applicable to the Project, Provider must be in compliance with the following laws, rules, and regulations; and any other state, federal, or local laws, rules, and regulations as may become applicable throughout the term of the Contract, and Provider acknowledges that this list may not include all such applicable laws, rules, and regulations.

**REQUEST FOR PROPOSAL
SEPTIC TANK SERVICES – RUNGE PARK
GALVESTON COUNTY, TEXAS**

Provider and is deemed to have read and understands the requirements of each of the following, if applicable to the Project under this Contract:

GENERALLY

The Acts and Regulations specified in this Contract;

Continuing Appropriations Act, 2018 and Supplemental Appropriations for Disaster Relief Requirements Act, 2017 (Public Law 115-56);

The Housing and Community Development Act of 1974 (12 U.S.C. § 5301 et seq.);

The United States Housing Act of 1937, as amended, 42 U.S.C. § 1437f(o)(13) (2016) and related provisions governing Public Housing Authority project-based assistance, and implementing regulations at 24 C.F.R. Part 983 (2016);

Cash Management Improvement Act regulations (31 C.F.R. Part 205);

Community Development Block Grants (24 C.F.R. Part 570);

Uniform Administrative Requirements, Cost Principles, and Audit Requirements for Federal Awards (2 C.F.R. Part 200);

Disaster Recovery Implementation Manual; and State of Texas Plan for Disaster Recovery: Hurricane Harvey – Round 1, dated April 6, 2018, as amended.

CIVIL RIGHTS

Title VI of the Civil Rights Act of 1964, (42 U.S.C. § 2000d et seq.); 24 C.F.R. Part 1, "Nondiscrimination in Federally Assisted Programs of the Department of Housing and Urban Development - Effectuation of Title VI of the Civil Rights Act of 1964";

Title VII of the Civil Rights Act of 1964, as amended by the Equal Employment Opportunity Act of 1972 (42 U.S.C. § 2000e, et seq.);

Title VIII of the Civil Rights Act of 1968, "The Fair Housing Act of 1968" (42 U.S.C. §3601, et seq.), as amended;

Executive Order 11063, as amended by Executive Order 12259, and 24 C.F.R. Part 107, "Nondiscrimination and Equal Opportunity in Housing under Executive Order 11063"; The failure or refusal of Provider to comply with the requirements of Executive Order 11063 or 24 C.F.R. Part 107 shall be a proper basis for the imposition of sanctions specified in 24 C.F.R. 107.60;

The Age Discrimination Act of 1975 (42 U.S.C. § 6101, et seq.); and

Section 504 of the Rehabilitation Act of 1973 (29 U.S.C. § 794.) and "Nondiscrimination Based on Handicap in Federally-Assisted Programs and Activities of the Department of Housing and Urban Development", 24 C.F.R. Part 8. By signing this Contract, Provider understands and agrees that the activities funded shall be performed in accordance with 24 C.F.R. Part 8; and the Architectural Barriers Act of 1968 (42 U.S.C. § 4151, et seq.), including the use of a telecommunications device for deaf persons (TDDs) or equally effective communication system.

LABOR STANDARDS

The Davis-Bacon Act, as amended (originally, 40 U.S.C. §§ 276a-276a-5 and re-codified at 40 U.S.C. §§ 3141-3148); 29 C.F.R. Part 5;

**REQUEST FOR PROPOSAL
SEPTIC TANK SERVICES – RUNGE PARK
GALVESTON COUNTY, TEXAS**

The Copeland "Anti-Kickback" Act (originally, 18 U.S.C. § 874 and re-codified at 40 U.S.C. § 3145): 29 C.F.R. Part 3;

Sections 103 and 107 of the Contract Work Hours and Safety Standards Act (originally, 40 U.S.C. §§ 327A and 330 and re-codified at 40 U.S.C. §§ 3701-3708);

Labor Standards Provisions Applicable to Contracts Covering Federally Financed and Assisted Construction (Also Labor Standards Provisions Applicable to Non-construction Contracts Subject to the Contract Work Hours and Safety Standards Act) (29 C.F.R. Part 5); and
Federal Executive Order 11246, as amended.

EMPLOYMENT OPPORTUNITIES

Section 3 of the Housing and Urban Development Act of 1968 (12 U.S.C. § 1701u): 24 C.F.R. §§ 135.3(a)(2) and (a)(3);

The Vietnam Era Veterans' Readjustment Assistance Act of 1974 (38 U.S.C. § 4212);

Title IX of the Education Amendments of 1972 (20 U.S.C. §§ 1681-1688); and

Federal Executive Order 11246, as amended.

GRANT AND AUDIT STANDARDS

Single Audit Act Amendments of 1996, 31 U.S.C. § 7501;

Uniform Administrative Requirements, Cost Principles, and Audit Requirements for Federal Awards (2 C.F.R. Part 200);

Uniform Grant and Contract Management Act (Texas Government Code Chapter 783) and the Uniform Grant Management Standards, issued by Governor's Office of Budget and Planning; and

Title 1 Texas Administrative Code § 5.167(c).

LEAD-BASED PAINT

Section 302 of the Lead-Based Paint Poisoning Prevention Act (42 U.S.C. § 4831(b)).

HISTORIC PROPERTIES

The National Historic Preservation Act of 1966 as amended (16 U.S.C. § 470, et seq.), particularly sections 106 and 110 (16 U.S.C. §§ 470 and 470h-2), except as provided in §58.17 for Section 17 projects;

Executive Order 11593, Protection and Enhancement of the Cultural Environment, May 13, 1971 (36 FR 8921), 3 C.F.R., 1971-1975 Comp., p. 559, particularly section 2(c);

Federal historic preservation regulations as follows: 36 C.F.R. Part 800 with respect to HUD programs; and The Reservoir Salvage Act of 1960, as amended by the Archeological and Historic Preservation Act of 1974 (16 U.S.C. § 469, et seq.), particularly section 3 (16 U.S.C. §469a-1).

ENVIRONMENTAL LAW AND AUTHORITIES

Environmental Review Procedures for Recipients assuming HUD Environmental Responsibilities (24 C.F.R. Part 58, as amended);

National Environmental Policy Act of 1969, as amended (42 U.S.C. §§ 4321-4347); and Council for Environmental Quality Regulations for Implementing NEPA (40 C.F.R. Parts 1500-1508).

**REQUEST FOR PROPOSAL
SEPTIC TANK SERVICES – RUNGE PARK
GALVESTON COUNTY, TEXAS**

FLOODPLAIN MANAGEMENT AND WETLAND PROTECTION

Executive Order 11988, Floodplain Management, May 24, 1977 (42 FR 26951), 3 C.F.R., 1977 Comp., p. 117, as interpreted in HUD regulations at 24 C.F.R. Part 55, particularly Section 2(a) of the Order (For an explanation of the relationship between the decision-making process in 24 C.F.R. Part 55 and this part, see § 55.10.); and

Executive Order 11990, Protection of Wetlands, May 24, 1977 (42 FR 26961), 3 C.F.R., 1977 Comp., p. 121 particularly Sections 2 and 5.

COASTAL ZONE MANAGEMENT

The Coastal Zone Management Act of 1972 (16 U.S.C. § 1451, et seq.), as amended, particularly sections 307(c) and (d) (16 U.S.C. § 1456(c) and (d)).

SOLE SOURCE AQUIFERS

The Safe Drinking Water Act of 1974 (42 U.S.C. §§ 201, 300(f), et seq., and 21 U.S.C. §349) as amended; particularly section 1424(e)(42 U.S.C. § 300h-3(e)); and

Sole Source Aquifers (Environmental Protection Agency-40 C.F.R. part 149).

ENDANGERED SPECIES

The Endangered Species Act of 1973 (16 U.S.C. § 1531, et seq.) as amended, particularly section 7 (16 U.S.C. § 1536).

WILD AND SCENIC RIVERS

The Wild and Scenic Rivers Act of 1968 (16 U.S.C. § 1271, et seq.) as amended, particularly sections 7(b) and (c) (16 U.S.C. § 1278(b) and (c)).

AIR QUALITY

The Clean Air Act (42 U.S.C. § 7401, et seq.) as amended, particularly sections 176(c) and (d) (42 U.S.C. §7506(c) and (d)).

Determining Conformity of Federal Actions to State or Federal Implementation Plans (Environmental Protection Agency-40 C.F.R. Parts 6, 51, and 93).

FARMLAND PROTECTION

Farmland Protection Policy Act of 1981 (7 U.S.C. § 4201, et seq.) particularly sections 1540(b) and 1541 (7 U.S.C. §§ 4201(b) and 4202); and

Farmland Protection Policy (Department of Agriculture-7 C.F.R. part 658).

HUD ENVIRONMENTAL STANDARDS

Applicable criteria and standards specified in HUD environmental regulations (24 C.F.R. Part 51)(other than the runway clear zone and clear zone notification requirement in 24 C.F.R. § 51.303(a)(3)); and

HUD Notice 79-33, Policy Guidance to Address the Problems Posed by Toxic Chemicals and Radioactive Materials, September 10, 1979.

ENVIRONMENTAL JUSTICE

Executive Order 12898 of February 11, 1994—Federal Actions to Address Environmental Justice in Minority Populations and Low-Income Populations, (59 FR 7629), 3 C.F.R., 1994 Comp. p. 859.

SUSPENSION AND DEBARMENT

Use of debarred, suspended, or ineligible contractors or subrecipients (24 C.F.R. §570.609);

**REQUEST FOR PROPOSAL
SEPTIC TANK SERVICES – RUNGE PARK
GALVESTON COUNTY, TEXAS**

General HUD Program Requirements; Waivers (24 C.F.R. Part 5); and

Nonprocurement Suspension and Debarment (2 C.F.R. Part 2424).

OTHER REQUIREMENTS

Environmental Review Procedures for Entities Assuming HUD Environmental Responsibilities (24 C.F.R. Part 58).

ACQUISITION / RELOCATION

The Uniform Relocation Assistance and Real Property Acquisition Policies Act of 1970 (42 U.S.C. § 4601, et seq.), 24 C.F.R. Part 42, and 24 C.F.R. § 570.606.

FAITH-BASED ACTIVITIES

Executive Order 13279 of December 12, 2002 - Equal Protection of the Laws for Faith-Based and Community Organizations, (67 FR 77141).

73. SPECIAL CONDITIONS – TEXAS GENERAL LAND OFFICE (GLO)

If applicable to a Project or Activity, Subrecipient must be in compliance with the following Special Conditions and any other State, Federal, or local laws, rules, and regulations as may be applicable, throughout the term of the Contract, prior to the release of any grant funds for the Projects or Activities anticipated.

Subrecipient is deemed to have read and to understand the requirements of each of the following, if applicable to the Project or any Activity under this Contract:

A. REIMBURSEMENT, GENERALLY

As provided for in Public Law 115-56, the Contract funds may not be used for activities that are eligible to be reimbursed by, or for which funds are made available by, (a) the Federal Emergency Management Agency (FEMA); (b) the Army Corps of Engineers (Corps); (c) any other federal funding source; or (d) covered by insurance, and Subrecipient shall ensure compliance with all such requirements.

B. NATIONAL FLOOD INSURANCE PROGRAM COMPLIANCE

- (1) Subrecipient must provide documentation which indicates they have received approval from the Texas Water Development Board (TWDB), the National Flood Insurance Program (NFIP) State Coordinating Agency, that appropriate ordinances or orders necessary for Subrecipient to be eligible to participate in the NFIP have been adopted.
- (2) Where Activities specified in a Performance Statement, involve structures that are located in Special Flood Hazard Areas (SFHA), flood insurance may be required, and Subrecipient shall obtain such insurance, and shall maintain documentation evidencing compliance with such requirements.
- (3) Subrecipient acknowledges and agrees that if any property that is the subject of an Activity under this Contract located within a floodplain, that the following terms and conditions shall apply:
 - a. Under the Flood Disaster Protection Act of 1973, as amended (42 U.S.C. 4001-4128), Federal financial assistance for acquisition and construction purposes (including rehabilitation) may not be used in an area identified by the Federal Emergency Management Agency (FEMA) as having special flood hazards, unless:
 - i. The community in which the area is situated is participating in the National Flood Insurance Program ("NFIP") (44 CFR parts 59 through 79), or less than one (1) year has passed since the FEMA notification regarding such hazards; and

REQUEST FOR PROPOSAL
SEPTIC TANK SERVICES – RUNGE PARK
GALVESTON COUNTY, TEXAS

- ii. The community is participating in the NFIP, or that flood insurance protection is to be obtained as a condition of the approval of financial assistance to the property owner.
- b. Where the community is participating in the NFIP and the recipient provides financial assistance for acquisition or construction purposes (including rehabilitation) for property located in an area identified by FEMA as having special flood hazards, Subrecipient is responsible for ensuring that flood insurance under the NFIP is obtained and maintained.
- c. Under Section 582 of the National Flood Insurance Reform Act of 1994, 42 U.S.C. 515a, HUD disaster assistance that is made available in a special flood hazard area may not be used to make a payment (including any loan assistance payment) to a person for repair, replacement, or restoration for flood damage to any personal, residential, or commercial property if:
 - i. The person had previously received Federal flood disaster assistance conditioned on obtaining and maintaining flood insurance; and
 - ii. The person failed to obtain and maintain flood insurance.
- d. Subrecipient understands and agrees that it has a responsibility to inform homeowners receiving disaster assistance that triggers the flood insurance purchase requirement of their statutory responsibility to notify any transferee of the requirement to obtain and maintain flood insurance, and that the transferring owner may be liable if he or she fails to do so.

C. PROJECT MAPPING/DESIGN INFORMATION

For construction projects, Subrecipient shall require and maintain copies, in written and/or digital format, of final Project record drawing(s) and engineering schematics, as constructed.

D. WATER SYSTEM IMPROVEMENTS

- (1) Prior to the GLO's release of funds for the construction of any water system improvements, Subrecipient shall provide certification to the GLO that plans, specifications, and related documents for the specified water system improvements have been prepared by the engineer selected for such activities, or the engineer's duly authorized representative, and that the review of such plans, specifications, and related documents meet the applicable Texas Commission on Environmental Quality (TCEQ) review requirements described in Title 30 of the Texas Administrative Code.
- (2) Prior to construction, Subrecipient shall provide documentation to the GLO that an approved new or amended Certificate of Convenience and Necessity (CCN), or the equivalent permit or authority for the area to be served, has been issued by the TCEQ.
- (3) Prior to Subrecipient submission of the Project Completion Report for any water system improvements described in Attachment A, Subrecipient shall provide a letter from the TCEQ that the constructed well is approved for interim use and may be temporarily placed into service pursuant to 30 Texas Administrative Code, Chapter 290—Rules and Regulations for Public Water Systems.

E. SEWER SYSTEM IMPROVEMENTS

Prior to the construction of any sewer system improvements described, Subrecipient shall provide certification that plans, specifications, and related documents for the specified sewer system improvements have been prepared by the engineer selected for such activities, or the engineer's duly authorized representative, and that the review of such plans, specifications, and related documents meet the Texas Commission on Environmental Quality (TCEQ) review requirements described in 30 Texas Administrative Code, Chapter 217, Subchapter D.

Further, prior to the construction of any sewer lines or additional service connections described in Attachment A, Subrecipient shall provide notification of the start of construction on any sewer treatment plant of other system-related improvements included in this Contract.

**REQUEST FOR PROPOSAL
SEPTIC TANK SERVICES – RUNGE PARK
GALVESTON COUNTY, TEXAS**

F. WASTEWATER TREATMENT CONSTRUCTION

Prior to incurring costs for any wastewater treatment construction in Attachment A, Subrecipient shall provide documentation of an approved permit or amendment(s) to an existing permit for such activities from the TCEQ's Water Quality Division.

In addition, Subrecipient shall provide documentation to the GLO that an approved new or amended Certificate of Convenience and Necessity (CCN), or equivalent permit or authority for the area to be served has been issued by the TCEQ.

G. SEPTIC SYSTEM IMPROVEMENTS

- (1) Subrecipient shall provide documentation that final plans, specifications, and installation of its septic system improvements have been reviewed and approved by the City or County Health Department through authority granted by the TCEQ.
- (2) Subrecipient shall mitigate all existing septic systems in accordance with 30 Texas Administrative Code Chapter 285, Subchapter D, §285.36(b), which states, "All tanks, boreholes, cesspools, seepage pits, holding tanks, and pump tanks shall have the wastewater removed by a waste transporter, holding a current registration with the executive director. All tanks, boreholes, cesspools, seepage pits, holding tanks, and pump tanks shall be filled to ground level with fill material (less than three inches in diameter), which is free of organic and construction debris."
- (3) Prior to the selection of program recipients for proposed On-Site Sewer Facilities (OSSF), Subrecipient shall provide a copy of its proposed program guidelines to for GLO review. All proposed OSSF programs must meet or exceed guidelines set forth in 30 Texas Administrative Code Chapter 285 Subchapter D.

H. BUILDING CONSTRUCTION

Subrecipient shall provide documentation that the construction of a new building and facilities are in compliance with the Texas Accessibility Standards (TAS) of the Architectural Barriers Act, Chapter 469, Texas Government Code, and the Texas Department of Licensing and Regulation (TDLR) Architectural Barriers Administrative Rules, 16 Texas Administrative Code, Part 4, Chapter 68. If estimated construction costs exceed Fifty Thousand Dollars (\$50,000.00), Construction Documents must be submitted to the Texas Department of Licensing and Regulation (TDLR) for an accessibility plan review.

I. BRIDGE CONSTRUCTION/REHABILITATION

Subrecipient shall use the minimum design requirements of the Texas Department of Transportation (TxDOT) for bridge construction/rehabilitation. Final plans and specifications must be submitted to TxDOT for review and approval prior to the start of construction, and documentation of such approval must be provided to the GLO.

J. DISASTER SHELTERS

Subrecipient shall ensure that the primary purpose of the facility, as described in Attachment A, is to serve as a disaster shelter, and shall ensure the facility is operated at all times in a manner that ensures that the priority use is to serve as a disaster shelter regardless of any other scheduled uses or commitments that existed at the time of the disaster or emergency situation. In addition, Subrecipient shall prepare or be incorporated into an approved emergency management plan, as prescribed by the Texas Division of Emergency Management, identifying the shelter as a facility that provides short-term lodging for evacuees during and immediately after an emergency situation. Subrecipient shall submit a copy of Subrecipient's Emergency Management Plan Annex for Shelter and Mass Care to the GLO.

K. DEBRIS REMOVAL

Subrecipient shall ensure that any debris to be removed consists primarily of vegetation, construction and demolition materials from damaged or destroyed structures, and personal property. Only debris identified as the responsibility of the local jurisdiction will be eligible for the reimbursement of cost of removal.

**REQUEST FOR PROPOSAL
SEPTIC TANK SERVICES – RUNGE PARK
GALVESTON COUNTY, TEXAS**

Prior to beginning debris collection operations, Subrecipient shall address all pertinent environmental concerns, adhere to all applicable regulations, and obtain all required permits. Further, Subrecipient shall adhere to the methods described herein for the collection and storage of debris prior to proper disposal.

While construction and demolition debris may be collected and disposed of at an appropriately rated landfill, woody and/or vegetative debris must be stored prior to disposal by use of temporary debris storage and reduction sites (TDSR). Subrecipient will prepare and operate the TDSR sites, or local jurisdictions choosing to conduct their own debris operations may review Chapter 7 of the FEMA Debris Management Guide regarding the use of TDSR sites. This document may be obtained <https://www.fema.gov/pdf/government/grant/pa/demagde.pdf>.

In order to maintain the life expectancy of landfills, Subrecipients disposing of woody and/or vegetative debris must choose burning, chipping, or grinding as the method of disposal. Any project disposing of woody and/or vegetative debris must be approved in writing by the GLO.

L. USE OF BONDS

Subrecipient must notify the GLO of its issuance and sale of bonds for completion of the project funded under this Contract.

M. PROGRAM GUIDELINES

Prior to the selection of program beneficiaries, Subrecipient shall provide to the GLO, for GLO review and approval, a copy of its proposed guidelines for the program. The guidelines must meet or exceed to requirements in the Federal Registers. The guidelines must include provisions for compliance with the Federal Fire Prevention and Control Act of 1974 (which requires that any housing unit rehabilitated with grant funds be protected by a hard-wired or battery-operated smoke detector) and provisions for compliance with 24 CFR 35 (HUD lead-based paint regulation).

N. AFFORDABILITY PERIODS FOR SINGLE-FAMILY HOUSING REHABILITATION, RECONSTRUCTION, OR NEW CONSTRUCTION ASSISTANCE:

For single-family non-rental housing assistance provided by Subrecipient, Subrecipient shall implement the following affordability period: for rehabilitation or reconstruction of housing projects, a minimum¹ three-year affordability period guaranteed by an unsecured forgivable promissory note and for new construction housing projects, a minimum² five-year affordability period guaranteed by an unsecured forgivable promissory note.

O. UNSECURED FORGIVABLE PROMISSORY NOTE (“NOTE”)

An unsecured forgivable promissory note shall be issued at an interest rate of zero-percent (0%). Provided that all terms and conditions contained in the Note continue to be fulfilled, a Note will be forgiven according to the following terms, as applicable, until the applicant fulfills their note requirement (the requirements are defined in the promissory note document): for a three-year Note, at a rate of 33 percent per year, for the first two years, and 34 percent after the third year; and for a five-year Note, at a rate of 20% per year.

- (1) If the homeowner occupies the home for the full Note term, the Note expires and no repayment is required, nor will any conditions be imposed relative to the disposition of the property. If any of the terms and conditions under which the assistance was provided are breached or if the property is sold, leased, transferred, or vacated by the homeowner for any consecutive thirty (30) day period during the Note term, the repayment provisions of the promissory note and DOT shall be enforced.
- (2) If, during the Note term, the homeowner vacates the unit for any consecutive thirty (30) day period, the locality may forgive, as evidenced by the program director, city council, or commissioner court action, the remaining loan balance. Prior to forgiveness of all or any portion of the assistance provided, the request for forgiveness must be approved by the local governing body and be based on documented and justifiable conditions or circumstances that would result in an unnecessary hardship to the

**REQUEST FOR PROPOSAL
SEPTIC TANK SERVICES – RUNGE PARK
GALVESTON COUNTY, TEXAS**

homeowner and the determination that the national objective of benefiting low to moderate-income persons was met.

- (3) The national objective will be considered met only when the program director, city council, or county commissioners court determines that a low- to moderate-income person has occupied the rehabilitated or reconstructed home for a time sufficient to meet the national objective. If the national objective was not achieved, Subrecipient is liable for repayment of an amount equal to the difference in the appraised value of the home prior to reconstruction and the sales price when the home is sold during the term of the forgivable Note.
- (4) If the property is sold or transferred to a person other than an eligible LMI person, the remaining pro-rated balance of the DPL must be repaid by the Subrecipient from the sales proceeds. Notwithstanding the preceding, Subrecipient shall be held liable for any balance remaining over and above the sales proceeds. In all instances, upon completion of the Note or repayment of the assistance (in full or in part), the Subrecipient shall prepare and record a release of lien document in the land records of the applicable county.
- (5) Monitoring of the Note is performed during and after the grant is closed. Subrecipient must utilize non-CDBG-DR funds to fulfill the monitoring obligations for its impacted recovered community.
- (6) The subrecipient will maintain a list of homeowners that do not maintain flood insurance as documented in their promissory note. These applicants will not be allowed to received future assistance as outlined in Section B of this document.

P. RENTAL HOUSING REHABILITATION, RECONSTRUCTION, OR NEW CONSTRUCTION ASSISTANCE

The rental housing assistance will provided be provided in the following forms: for rehabilitation or reconstruction of multi-family rental projects with eight or more units, a minimum fifteen (15) year forgivable loan or grant at zero interest; and for new construction multi-family rental projects with five or more units, a minimum twenty (20) year forgivable loan or grant at zero interest. Provided all terms and conditions under which the assistance was provided continue to be fulfilled, the note will be forgiven at a rate of 5 percent per year until the applicant fulfills their note requirement (the requirements are defined in the promissory note document).

The purpose of the program is to facilitate the rehabilitation, reconstruction, and/or new construction of affordable rental housing needs within the service area of the disaster event. A minimum of 51% of the multi-family units must be restricted during the affordability period of twenty (20) years for low to moderate income (LMI) persons. The rents, at a minimum, must comply with High HOME Investment Partnership (HOME) Rents and other existing Land Use Restriction Agreement (LURA) restrictions if applicable. HOME rent limits are defined by HUD and must equal the lesser of fair market rents or 30% of the adjusted income for people earning 65% of the AMFI.

Q. COASTAL MANAGEMENT

Subrecipient acknowledges and agrees that any Project that may impact a Coastal Natural Resource Area must be consistent with the goals and policies of the Texas Coastal Management Program as described in 31 Texas Administrative Code, Part 16, Chapter 501.

74. ENERGY EFFICIENCY (42 U.S.C. 6201 and 2 CFR 200 APPENDIX II (H))

Contractor must comply with the mandatory standards and policies relating to energy efficiency, which are contained in the state energy conservation plan issued in compliance with the Energy Policy and Conservation Act (42 U.S.C. 6201). Contractor must include this provision in all contracts between itself and any subcontractors in connection with the services performed under this Contract.

**REQUEST FOR PROPOSAL
SEPTIC TANK SERVICES – RUNGE PARK
GALVESTON COUNTY, TEXAS**

75. LEAD AND ASBESTOS

If this request for Proposal involves remediation, demolition, reconstruction, rehabilitation, repair, or construction, or other applicable activities, the Contractor shall be responsible for performing investigations of lead and asbestos containing materials, and any required lead and asbestos abatement in compliance with Federal, State, and local laws, rules, regulations, ordinances and orders, relating to lead abatement and asbestos abatement as applicable, including but not limited to the Texas Asbestos Health Protection Act, codified as Chapter 1954 of the Occupations Code; the Texas Asbestos Health Protection Regulations, located at Title 25, Part 1, Chapter 295, Subchapter C of the Texas Administrative Code; Chapter 1955 of the Texas Occupations Code (lead-based paint abatement); the Texas Environmental Lead Reduction regulations, located at Title 25, Part 1, Chapter 295, Subchapter I of the Texas Administrative Code; the federal National Emission Standards for Asbestos regulations, located at Title 40, Part 61, Subpart M of the Code of Federal Regulations, and the National Emission Standards for Hazardous Air Pollutants. Contractor shall perform such inspections, encapsulation, remediation, or other actions as required by federal, State, or local requirements in accordance with the federal Environmental Protection Agency (EPA), Texas Department of State Health Services (TXDSSH), and Texas Commission on Environmental Quality (TCEQ) requirements.

76. USE OF DHS SEAL, LOGO, AND FLAGS PROHIBITED WITHOUT PRIOR APPROVAL

Contractor must obtain permission from the U.S. Department of Homeland Security financial assistance office (DHS FAO) **prior** to using DHS seals(s), logos, crests, or reproductions of flags or likenesses of DHS agency officials, including use of the United States Coast Guard seal, logo, crests or reproductions of flags or likenesses of Coast Guard Officials.

77. FEDERAL GOVERNMENT NOT A PARTY

Contractor acknowledges that the Federal Government is not a party to the contract and is not subject to any obligations or liabilities to Galveston County, contractor, or any other party pertaining to any matter resulting from the contract.

78. PROGRAM FRAUD AND FALSE OR FRAUDULENT STATEMENTS OR RELATED ACTS

In contracts funded through Federal grants, Contractor acknowledges that 31 U.S.C. Chapter 38, Administrative Remedies for False Claims and Statements (31 U.S.C. § 3801, et seq.) and the implementing regulations thereunder, 49 C.F.R. Part 79, apply to Contractors actions pertaining to the contract.

79. ACKNOWLEDGMENT OF GOVERNMENT RECORD

Proposer acknowledges that its submission in this Request for Proposals, including its Proposal, certifications, affidavits, Vendor Forms (i.e., PEID, W-9, CIQ, etc.) constitutes government records under Chapter 37 of the Texas Penal Code.

80. COMPLIANCE WITH GALVESTON COUNTY PURCHASING POLICIES AND PROCEDURES

Proposer acknowledges, by its submission in this request for Proposals, that it shall comply with the Galveston County Purchasing Policies & Procedures Manual approved by Order of the Galveston County Commissioners' Court on March 7, 2018.

81. ENTIRETY OF AGREEMENT AND MODIFICATION

This contract contains the entire agreement between the parties. Any prior agreement, promise, negotiation, or representation not expressly set forth in this contract has no force or effect. Any subsequent modification to this contract must be in writing, signed by both parties.

**REQUEST FOR PROPOSAL
SEPTIC TANK SERVICES – RUNGE PARK
GALVESTON COUNTY, TEXAS**

An official representative, employee, or agent of the County does not have the authority to modify or amend this contract except pursuant to specific authority to do so granted by the Galveston County Commissioners' Court.

The remainder of this page intentionally left blank

82. NOTICE

All notices or other communications required or permitted under this contract shall be in writing and shall be deemed to have been duly given if delivered personally in hand, transmitted by facsimile, or mailed certified mail, return receipt requested with proper postage affixed and addressed to the appropriate party at the following address or at such other address as may have been previously given in writing to the parties (Proposer shall provide its notice information with its Proposal submission). If mailed, the notice shall be deemed delivered when actually received, or if earlier, on the third day following deposit in a United States Postal Service post office or receptacle, duly certified, return receipt requested, with proper postage affixed. If delivered in person, notice shall be deemed delivered when receipted for by, or actually received by the receiving Party. If transmitted by facsimile, notice shall be deemed delivered when receipt of such transmission is acknowledged.

To the County at:

Hon. Mark Henry,
County Judge of Galveston County
722 Moody (21st Street), Second (2nd) Floor
Galveston, Texas 77550
Fax: (409) 765-2653

With copies to:

Rufus Crowder, CPPO CPPB,
Galveston County Purchasing Agent
722 Moody (21st Street), Fifth (5th) Floor
Galveston, Texas 77550
Fax: (409) 621-7997

To the Contractor at:

**REQUEST FOR PROPOSAL
SEPTIC TANK SERVICES – RUNGE PARK
GALVESTON COUNTY, TEXAS**

End of General Provisions

SPECIAL PROVISIONS

**REQUEST FOR PROPOSAL
SEPTIC TANK SERVICES – RUNGE PARK
GALVESTON COUNTY, TEXAS**

TABLE OF CONTENTS

A.	PURPOSE	2
B.	EXCEPTIONS	2
C.	PROCUREMENT TIMELINE	2
D.	SUBMISSION INSTRUCTIONS.....	3
E.	PROPOSAL SURETY.....	3
F.	PERFORMANCE AND PAYMENT BONDS.....	3
G.	BEST AND FINAL OFFERS (BAFO)	3
H.	DAVIS-BACON WAGE RATES	3
I.	PERSONNEL TO CONTACT	4
J.	PROGRAM ADMINISTRATION & CONTRACT MANAGEMENT.....	5
K.	REQUIREMENTS OF REQUEST FOR PROPOSAL.....	5
L.	INSURANCE.....	5
M.	SCOPE OF WORK	6
N.	COST	6
O.	INVOICES:	6
P.	EVALUATION AND SELECTION PROCESS	7

SPECIAL PROVISIONS

REQUEST FOR PROPOSAL SEPTIC TANK SERVICES – RUNGE PARK GALVESTON COUNTY, TEXAS

The General Provisions and the Special Provisions of this Request for Qualification and the Exhibits attached hereto are made a part of this agreement between the Parties. In the event of a conflict between the General Provisions and the Special Provisions, the terms of the Special Provisions shall control.

A. PURPOSE

Galveston County is seeking proposals for a professional and qualified contractor to repair the onsite septic facility (OSSF) and replace the drip field at the following location:

Runge Park
4605 Peck Avenue
Santa Fe, Texas 77510

This septic tank system services the bathrooms located in the concession building at the Runge Park Ballfield Complex.

Norex Engineering has designed plans for the modified aerobic septic drip disposal system. The successful contractor has the option to provide an alternate design as long as it adheres to all city, county, and state requirements as required by TCEQ. New engineered designed plans would be the responsibility of the contractor if they don't follow the provided design.

Respondents shall provide a response that will address the required services shown in the Scope of Work.

B. EXCEPTIONS

Any exceptions to these solicitation conditions should be listed on a separate sheet of paper, attached to respondent's submittal, and submitted with response at the specified date and time of the solicitation opening.

C. PROCUREMENT TIMELINE

A timeline for this solicitation and initial process is included below. Galveston County reserves the right to change these dates and will notify Respondents of any changes:

Advertise Solicitation (first date of publication)	Tuesday, January 24, 2023
Advertise Solicitation (second date of publication)	Tuesday, January 31, 2023
Deadline for Questions & Inquiries	Tuesday, February 7, 2023, by 5:00 p.m.
Submission Deadline / RFP Opening	Friday, February 24, 2023, at 2:00 p.m.

Interested parties can attend the Friday, February 24, 2023, 2:00 p.m. virtual bid opening at the link mentioned below:

Join from the meeting link

<https://galvestoncountytexas.webex.com/galvestoncountytexas/j.php?MTID=ma9da7ac4edeefef9719ef44a8576cc3>

Join by meeting number

Meeting number (access code): 2483 711 7487

Meeting password: B231010 (2231010 from video systems)

SPECIAL PROVISIONS

REQUEST FOR PROPOSAL SEPTIC TANK SERVICES – RUNGE PARK GALVESTON COUNTY, TEXAS

Tap to join from a mobile device (attendees only)
+1-415-655-0001,,24837117487## US Toll

Join by phone
+1-415-655-0001 US Toll
Global call-in numbers

Join from a video system or application
Dial 24837117487@galvestoncountytexas.webex.com

D. SUBMISSION INSTRUCTIONS

One (1) single-sided unbound original proposal, four (4) single-sided proposal copies, and one (1) digital copy on a USB drive (thumb drive) must be submitted no later than **2:00 P.M. CST, on Tuesday, January 24, 2023:**

Rufus G. Crowder, CPPO CPPB
Purchasing Agent
County of Galveston
722 Moody Avenue (21st Street), Fifth (5th) Floor
Galveston, TX 77550

The timestamp clock located in the Purchasing Agent's office shall serve as the official timekeeping piece for this solicitation process. Any proposals received after **2:00 P.M. CST** on the specified date will be returned unopened.

Proposal Specifications can be obtained at the office of the Galveston County Purchasing Agent, located in the Galveston County Courthouse, 722 Moody, (21st Street), Floor 5, Purchasing, Galveston, Texas 77550, or by visiting the Galveston County website @ <http://www.galvestoncountytexas.gov/county-offices/purchasing>

E. PROPOSAL SURETY

A 5% surety/bond (bid bond) is a requirement of this solicitation.

F. PERFORMANCE AND PAYMENT BONDS

Performance and Payment Bonds are requirements of this solicitation.

G. BEST AND FINAL OFFERS (BAFO)

The Best and Final Offer process is **applicable** to this solicitation.

H. DAVIS-BACON WAGE RATES

Attention is called to the fact that not less than, the federally determined prevailing (Davis-Bacon and Related Acts) wage rate, as issued by the Office of Rural Community Affairs and contained in the contract documents, must be paid on this project. In addition, the successful Responder must ensure that employees and applicants for employment are not discriminated against because of race, color, religion, sex age or national origin.

SPECIAL PROVISIONS

REQUEST FOR PROPOSAL SEPTIC TANK SERVICES – RUNGE PARK GALVESTON COUNTY, TEXAS

I. PERSONNEL TO CONTACT

Respondents desiring an explanation or interpretation relative to this solicitation must request it in writing. Oral explanations or instructions will not be binding. Any information given to a Respondent, which in the opinion of the County affects all Respondents or would be prejudicial to other Respondents if not communicated, shall be furnished to all Respondents as an addendum to the solicitation. Respondents **must** direct all inquiries to the following:

Rufus G. Crowder, CPPO CPPB
Purchasing Agent
722 21st Street (Moody)
Galveston, Texas 77550
e-mail: purchasing.bids@co.galveston.tx.us

Respondents must e-mail their requests (with the subject line “**Septic Tank Services—Runge Park– RFP #B231010– Questions**”) for additional information and/or clarification to the address listed above. The request must include the Responder’s name and the solicitation number and title.

Any request for additional information or clarification must be received in writing no later than ten (10) calendar days prior to the solicitation due date. Late requests or those not delivered to the proper address may not receive a reply. Respondents shall not attempt to contact the County by any other means. The Purchasing Agent shall post the answers on the County website from the procurement web page and via addendum.

The County will issue responses to inquiries and any other corrections or amendments, it deems necessary, in the form of a written addendum, issued prior to the solicitation Submission Deadline / Solicitation Opening date. The County, at its sole discretion, may not issue a response to an RFI submittal. Respondents should not rely on any oral or written representations, statements, or explanations, other than those made in this solicitation or in any written addendum to this solicitation. Where there appears to be conflict between the solicitation and any issued addenda, the last addendum issued will prevail.

Addenda will be posted and made available on the County’s procurement web page. **It is the Responder’s sole responsibility to ensure receipt of all addenda prior to submitting its response.** All Respondents should check the County’s procurement web page for all addenda prior to submitting a response.

The County’s procurement web page is located at <http://www.galvestoncountytexas.gov/county-offices/purchasing>

The Respondent must acknowledge the receipt of all addenda on the forms provided. In the event a Responder fails to acknowledge receipt of such addenda, the County may, at its sole discretion, determine that such failure to acknowledge any or all addenda does not materially affect the solicitation and waive the acknowledgement of one or more addenda.

Respondents who submit inquiries *after* the deadline date for receipt of questions indicated on the Procurement Timeline, risk that its response in the procurement will not be responsive or competitive because the County is not able to respond before the solicitation receipt date or in sufficient time for the Responder to prepare a responsive or competitive submittal.

All questions and responses as posted on the County website pertaining to this solicitation are considered an addendum to, and part of, this solicitation. Each Responder shall be responsible to monitor the County website for new or revised solicitation information. The County shall not be bound by any verbal information, nor shall it be bound by any written information that is not either contained within the solicitation or formally issued as an addendum by the Purchasing Agent.

SPECIAL PROVISIONS
REQUEST FOR PROPOSAL
SEPTIC TANK SERVICES – RUNGE PARK
GALVESTON COUNTY, TEXAS

J. PROGRAM ADMINISTRATION & CONTRACT MANAGEMENT

The Program Administrator/Contract Manager that will manage the work to be performed under the resultant contract for the purpose of this solicitation is:

Julie Diaz
Parks Director
4102 Main Street, La Marque, TX 77568

The Galveston County Commissioners' Court, and/or authorized designees will be responsible for negotiating with the successful Vendor the scope of work, the standards of performance, the specific technology provided, and the support services required for the proposed projects. All contractual amendments will be processed in accordance with Galveston County Purchasing Policies. Amendments will also be brought to Galveston County Commissioners Court for approval as deemed necessary. The approval process serves to ensure the project technology and/or service is within the scope of the resultant contract, that pricing meets the agreed-upon pricing methodology as specified in the contract, and that funds are available.

K. REQUIREMENTS OF REQUEST FOR PROPOSAL

Respondent shall provide one (1) single-sided original and four (4) single-sided hard copies of its response, and one electronic copy of its response (thumb drive), to the Purchasing Agent on or before the submission deadline specified herein. Font size is limited to no smaller than font size 11, except that organizational charts, other graphics, and footers may be as small as font size 9.

L. INSURANCE

Responder must submit, with its response, a current certificate of insurance evidencing coverage in the amounts specified below or greater. In lieu of submitting a certificate of insurance, Respondents may submit a notarized statement from an insurance company authorized to conduct business in the State of Texas guaranteeing that Respondent has such insurance. Provided however, that successful Respondent(s) shall be required to provide a current certificate of insurance to the Galveston County Purchasing Agent's Office before Respondent commences any work hereunder. **Insurance shall be placed with insurers having an A.M. Best's rating of no less than A.** Such insurance must be issued by a casualty company authorized to do business in the State of Texas, and in standard form approved by the Board of Insurance Commissioners of the State of Texas, with coverage provisions ensuring the public from loss or damage that may arise to any person or property by reason of services rendered by Contractor.

Galveston County shall be listed as an additional insured on each policy and all certificates of insurance and Contractor shall provide Galveston County with no less than thirty (30) calendar days prior notice of any changes to the policy during the contractual period.

Certificates of Insurance, fully executed by a licensed representative of the insurance company written or countersigned by an authorized Texas state agency, shall be filed with the County Purchasing Agent within ten (10) calendar days of the execution of this Agreement as written proof of such insurance and further provided that Contractor shall not commence work under this Agreement until Contractor has obtained all insurance required herein, provided written proof as required herein, and received written notice to proceed issued from the County Purchasing Agent. **Failure to provide such evidence of insurance within the ten (10) calendar day period shall constitute an event of default.**

Workers' Compensation Insurance. Respondent shall carry in full force Workers' Compensation Insurance Policy(ies), if there is more than one employee, for all its employees, including but not limited to full time, part time, and emergency employees employed by the Contractor.

SPECIAL PROVISIONS

REQUEST FOR PROPOSAL SEPTIC TANK SERVICES – RUNGE PARK GALVESTON COUNTY, TEXAS

Commercial General Liability. Respondent shall carry in full force commercial general liability insurance with a limit of not less than \$1,000,000 each occurrence and \$2,000,000 in the aggregate. The Policy shall, minimally, cover liability for bodily injury, personal injury, and property damage.

Business Automobile Liability. Respondent shall carry in full force business automobile liability coverage with a combined bodily injury/property damage limit of not less than \$1,000,000 each accident. The policy shall cover liability arising from the operation of licensed vehicles by policyholder.

Subrogation Waiver. Contractor and Contractor's insurance carrier shall waive any and all rights to subrogation against Galveston County in regard to any suit or claim arising out of personal injury or property damage resulting from Contractor's performance under this Agreement.

M. SCOPE OF WORK

The successful contractor must have professional commercial experience of repairing/installing OSSF (onsite septic facilities) and repairing/installing an aerobic septic drip disposal system. Contractor must be licensed in the State of Texas and adhere to all local, state, and TCEQ guidelines.

The scope of work includes the following:

General Notes:

- Contractor to utilize flex connectors at all supply and return connections.
- Supply line manifold to be 6" higher than return line manifold.
- Automatic flush-solenoid valve can be installed on return line in lieu of ball valve.
- Automatic pressure regulator may be utilized in lieu of age valve for pressure and flow control to disposal field.
- Per TCEQ rules return flush line to pre-treatment or pump tanks depending on flush method utilized.
- Use a k-rain solenoid valve or equal with lutlip zone systems.
- All emitter lines to be pressure compensated NETAFIM-BILINE polyethylene tubing or equal. This is a site-specific design taking into consideration soil type, ground water, and topography and is suitable for operations in the environment.

Site-Specific Notes:

- Install low-flow toilet and bathroom fixtures.
- Till in a minimum class II solid (soady loam, loam) Place irrigation lines over soil, then cover with new top oil/carpet grass. Finish grade to crown slightly in center (see typical drip field cross section).
- Drainage shall be provided as shown, contractor shall ensure no standing water and adequate drainage.

For more specifics, please reference provided engineered design plans attached to this solicitation. Contractor will provide specific scope of work to complete job in their proposal.

N. COST

Any unit prices submitted by the proposer shall include all costs to the County, including the material, delivery, current freight rate, state tax, or any other associated costs.

O. INVOICES:

Invoices must be itemized indicating all materials and supplies used. Invoices must be submitted to:

Galveston County Auditor's Office
Attn: Accounts Payable

SPECIAL PROVISIONS

REQUEST FOR PROPOSAL
SEPTIC TANK SERVICES – RUNGE PARK
GALVESTON COUNTY, TEXAS

P.O. Box 1418
Galveston, Texas 77553

Failure to submit invoices to the above address or failure to include the Purchase Order Number will result in delay in payment.

Contractor must accept purchase order numbers for specified supplies, equipment, and/or services. Contractor shall not perform any work or release any supplies and/or equipment to any authorized representative of the County of Galveston unless a valid purchase order number issued by the office of the Galveston County Purchasing Agent accompanies the order or if vendor can comply with the provision as stated in the General Provisions, page 3, item 11, Procurement Card Program.

Payment for any items issued without prior receipt of a valid purchase order number may become the sole responsibility of the successful contractor.

P. EVALUATION AND SELECTION PROCESS

An evaluation committee shall review and evaluate the responses timely submitted to the County Purchasing Agent resulting from this solicitation effort. Responses shall be reviewed by the evaluation committee and shall be evaluated in accordance with the evaluation criteria listed herein. The evaluation committee will determine which responses are qualified based on the criteria listed below. The evaluation committee shall evaluate and score each response. The points from each scoring category will be comprised from the following:

- **Competence — 40 points:** A brief narrative describing how the project will be developed and monitored, including a time frame for specific tasks and overall completion. Describe how the services will be provided and how they will be supported. Qualifications, financial stability, and previously related experience will be evaluated.
- **Qualifications - 20 points:** Qualifications of key personnel that would be assigned to this project. Identify the project manager and their relevant experience. Provide documentation that the installer of the project is a licensed OSSF (Onsite Septic Facility) installer in the State of Texas.
- **Pricing - 30 points:** Overall cost to complete the entire project.
- **References – 10 points:** Listing of experience in the type of work contemplated by this proposal. Include both overall experience and projects (specific) completed in the State of Texas. Provide names, addresses, and phone numbers of clients of recent similar projects.

By the submission of its response to this solicitation, the Respondent accepts the requirements, formatting, and the evaluation process referenced herein.

Norex Engineering, Inc.

1220 East Main
League City, Texas 77573
281-474-2640
office@norexengineering.net

Galveston Co. Parks Department
Jimmy Gibson
4102 Main Street
La Marque, TX 77568
Jimmy.gibson@co.galveston.tx.us
409-996-7629

April 4, 2022

**Re: Proposed Commercial Aerobic OSSF
Runge Ball Park
4605 Peck
Santa Fe, Texas 77517**

Dear Mr. Gibson,

Norex Engineering, Inc (NOREX) is pleased to offer Galveston Co. Parks Department (CLIENT) our proposal/agreement for the above referenced Project. The scope of the work outlined below is based on information and direction provided by you and represents our general understanding of the project. This proposal/agreement and scope of work is inclusive of all requirements that can be reasonably interpreted from the information we have been provided to date.

PART 1 – BASIC SCOPE OF SERVICES

The following is an outline of engineering services associated with the Project referenced above. Engineering fees for the referenced Project are detailed below. Additional services outside the scope of work outlined in this proposal/agreement will be bid on an individual basis and must be approved prior to the commencement of said services.

1.0 FEASIBILITY OF PROPOSED USAGE PHASE

- Evaluation and acceptance of CLIENT provided documentation. To be performed upon NOREX's receipt of all required documentation.
 - Project Information – Shown on NOREX Customer Intake Form
 - Site address of legal description
 - System preference (spray or drip)
 - Proposed future expansion or site features, if any
 - Water Source*
 - Clear and legible official county recorded professional survey, showing all existing on-site easements. (i.e.: pipeline, mechanical/electrical/plumbing, aerial, etc.)
 - CLIENT provided site layout showing location of all proposed or existing
 - Buildings/Structures
 - Any surface improvements (i.e.: sidewalks, driveways)
 - Water well(s)
 - Any underground service lines (i.e.: water, natural gas)
 - Preferred location of aerobic treatment system tanks and disposal field
- Identify issues that may need to be addressed prior to moving forward with design. Discuss with CLIENT any changes required to accommodate CLIENT's design and construction standards. For

example, NSF approved equipment make/model selections and/or any additional component selections (i.e.: spray heads, drip lines, manufacturer. etc.).

2.0 ON SITE ASSESSMENT PHASE

- Evaluate and record existing site conditions on both the subject and adjacent property

3.0 PRELIMINARY "NOT FOR CONSTRUCTION" SITE LAYOUT AND OSSF SIZING PHASE

- Create aerial view of site specifying all existing and proposed site-specific features, buildings, easements and required state/local offsets or buffer areas.
- Provide initial estimate of proposed/existing effluent flow rates in OSSF format as identified by TCEQ or applicable OSSF systems design standard.
- Display estimated disposal field area (spray or drip), delineated to scale on aerial view.
- Estimate state or county specific aerobic treatment system capacity requirements.
- Display location of proposed water lines and existing/proposed water wells with required offsets.
- Any/all design and construction standards not specified by CLIENT during feasibility phase shall be made at NOREX'S professional discretion and will remain part of the final plans and specifications. Revisions to said design and construction standards will incur additional fees to CLIENT.

4.0 CONSTRUCTION PLANS AND SPECIFICATIONS

- Final stamped OSSF Design, based upon CLIENT'S approval of NOREX'S preliminary site layout and OSSF sizing.
- Design to include BOD calculations, daily flow, disposal area, pump requirements and specified NSF approved equipment.
- Provide current FEMA National Flood Hazard FIRMette.
- Provide Site Evaluation Form.
- Provide additional documentation as required for site specific conditions
- NOREX'S final plans and specifications shall be valid for one (1) year following the date of the final stamped plans and/or specifications. CLIENT's use of NOREX plans beyond 1- year shall not be permitted without written verification, completion, or adaptation by NOREX, as appropriate for the specific purpose intended.
- Following delivery to CLIENT, any/all revisions to final NOREX plans not the result of a NOREX plan error that are requested by permit-runner/permitting agency/municipality/CLIENT are subject to a minimum fee of \$150.00 per revision. Revision fee(s) shall be applicable to all revisions that result from permit-runner service errors, non-published municipal code/law/ordinances, etc.

3.0 PERMITTING SERVICES

N/A

4.0 CONSTRUCTION PHASE SERVICES

N/A

In the event the CLIENT requests NOREX to alter the Engineering Services Scope of this proposal/agreement, or add additional tasks hereto, it will be necessary for the CLIENT to request an amendment to this proposal/agreement from NOREX. Upon receipt of the fully executed revised proposal/agreement, NOREX shall authorize the alteration of the Engineering Services Scope and reserves the right to charge any additional hours/fees to affect the modification.

PART 2 – RATES FOR PERFORMING BASIC SERVICES

Norex agrees to perform the work complete in strict compliance with the terms and conditions of the proposal/agreement based on the following schedule of values.

- Project Assessment / Preliminary Site Layout and Sizing \$ 750.00
- Construction Plans and Specifications \$ 1,500.00
- Estimated Total \$ 2,250.00

PART 3 - ADDITIONAL SERVICES

The following services are not included under this proposal/agreement and shall be deemed as Additional Services requiring CLIENT’S written authorization. If authorized in writing by CLIENT, NOREX shall furnish or obtain from others, the Additional Services of the types listed below.

1. None.

PART 4 - ADDITIONAL SERVICES RATES

In the event the parties agree to expand the proposal/agreement to include any Additional Services outside the scope of those detailed in Part 1, those services will be bid on an individual basis and must be approved by CLIENT prior to the commencement of said services. CLIENT agrees to pay Norex based on an amendment to the proposal/agreement and one of the following options:

1. Fixed Price: Work based on agreed price; or
2. Hourly Rates: Hourly rates for the actual time worked in connection with the additional work.

Rate Description	Hourly Rate	Rate Description	Hourly Rate
Principal Engineer	\$225.00	CAD Designer	\$95.00
Senior Engineer	\$200.00	Construction/Field Inspector	\$85.00
Project Manager	\$125.00	Executive Assistant	\$75.00

PART 5 - COMPENSATION FOR REIMBURSABLE EXPENSES

CLIENT shall pay NOREX for all Reimbursable Expenses at the rates set forth in Part 6 – **Reimbursable Expense Schedule**. Reimbursable Expenses include, but are not limited to, the following categories: mileage, deliveries, reproduction of reports, and similar project related items. To the extent necessary to verify NOREX’S charges and upon CLIENT’S timely request, NOREX shall make copies of such records available to CLIENT at cost.

The amounts payable to NOREX for Reimbursable Expenses will be the project-related internal expenses actually incurred or allocated by NOREX, plus all invoiced external Reimbursable Expenses allocable to the Project, the latter multiplied by a factor of 1.15.

PART 6 - REIMBURSABLE EXPENSE SCHEDULE

Expense Description	Rates	Expense Description	Rates
Automobile Mileage	\$0.585/mile	8.5"x11" Copies	\$0.10/per
Sub-Consultant Services	Cost + 15%	17"x11" Copies	\$1.00/per
Permit/Development Review Fees	Cost + 15%	Delivery Services	Cost + 15%

PART 7 – BILLING

A down payment of the preliminary site layout and OSSF sizing fee (\$750.00) is due prior to NOREX commencing services. Documents/drawings/plans, etc. will be released only upon payment in full of any/all outstanding balance(s). Preliminary design fee is non-refundable. Any/all down payment made by CLIENT will be subject to forfeiture if CLIENT cancels or delays the project sixty (60) days or more beyond the approval date of this proposal/agreement. NOREX will, where applicable, provide monthly invoices for the Project. Remittance will be due within 30 days of the invoice date. The total amount billed by NOREX will not exceed the total amount of the accepted proposal/agreement without prior authorization from CLIENT.

PART 8 - PROJECT SCHEDULE

The estimated completion of the preliminary design is approximately 15-20 business days following NOREX'S receipt of a signed copy of this proposal/agreement, down payment and any/all requested documents. Completion of the final OSSF design, will be approximately 10-15 business days following the satisfactory completion and CLIENT approval of the preliminary OSSF design.

AUTHORIZATION TO PROCEED

NOREX will commence the services outlined above upon receipt of the down payment and this proposal/agreement, signed by CLIENT or an authorized representative of CLIENT. Please review this proposal/agreement and return to our office at your earliest convenience. In the event this proposal is not executed within a 30-day period from the date issued, NOREX retains the right to modify the fees and any Project scheduling.

NOREX. appreciates the opportunity to offer our services to you and look forward to providing our support on this Project. If you have any questions, or need further information regarding this proposal/agreement, please contact our office.

Sincerely,
Michael T. Scanlon, P.E.
Norex Engineering, Inc.
MTS/de

Authorization to Proceed Signed/ Galveston Co. Parks Department

Authorization to Proceed Print Name/ Galveston Co. Parks Department

Authorization to Proceed/Date Signed

OR:

Authorization to Proceed Signed/ Designated Representative

Authorization to Proceed Print Name/ Designated Representative

Authorization to Proceed Title/ Designated Representative

Authorization to Proceed/Date Signed

EXHIBIT A
GENERAL CONDITIONS OF THE AGREEMENT

NOREX and CLIENT are each a Party and may sometimes be collectively referred to as the Parties and hereby agree to the following:

1. **SERVICES PROVIDED BY NOREX:** In connection with the Project, NOREX shall provide, or cause to be provided, the services set forth herein and in Part 1 of the proposal/agreement (collectively, the "Services").
2. **CLIENT RESPONSIBILITIES:**
 - a. Provide NOREX with CLIENT'S requirements for the Project including survey, current site plan, proposed usage information, reports and data relative to previous designs, or investigations at or adjacent to the site, and design and construction standards which CLIENT will require to be included in the drawings and specifications; when applicable.
 - b. CLIENT shall be responsible for, and NOREX may rely upon, the accuracy and completeness of all requirements, programs, instructions, reports, data, and other information furnished by CLIENT to NOREX pursuant to this proposal/agreement. NOREX may use such information in performing or furnishing Services under this proposal/agreement.
 - c. CLIENT shall pay NOREX for any/all Services and Reimbursable Expenses as set forth in Parts 1-6 of the proposal/agreement.
3. **SCHEDULE FOR RENDERING SERVICES.** NOREX shall begin rendering Services as of the effective date of the proposal/agreement (effective date is the date upon which Norex has received a signed copy of the proposal/agreement, all requested Project documents and down payment, where applicable). CLIENT shall notify NOREX if it has schedule or contract deadlines prior to the start of work. Acquisition of CLIENT provided Information or documents may affect the Project schedule.
4. **INVOICES AND PAYMENTS:**
 - a. Invoices: Norex shall submit to CLIENT either (a) monthly invoices for Services rendered and reimbursable expenses incurred in the preceding month, or (b) invoices based on the completion of any phase of Project
 - b. Compensation for Services: CLIENT agrees with the fees as set forth in Part 2 of the proposal/agreement and shall pay for Services rendered within thirty (30) days of the date on such invoice
 - c. Down Payment: Upon execution of this proposal/agreement, CLIENT shall deposit with NOREX the amount noted in Part 7 of the proposal/agreement as a down payment. NOREX shall apply the down payment to services rendered until the funds have been fully exhausted. CLIENT shall then pay NOREX for any/all remaining balance(s) and/or invoice(s) as previously described
 - d. Suspension of Work: If CLIENT fails to pay any invoice within sixty-one (61) days and there are insufficient funds from the down payment to pay such invoice, NOREX may, at its sole discretion give seven (7) days written notice to CLIENT and suspend Services under this proposal/agreement until CLIENT has paid in full all amounts owed by CLIENT, CLIENT hereby irrevocably waives any and all claims against NOREX for any such suspension.

- e. **Failure to Pay:** If CLIENT fails to pay any invoice after ninety-one (91) days and does not provide written communication regarding payment, NOREX may, at its sole discretion, pursue legal proceedings.
5. **OPINIONS OF COST:** When included in NOREX'S scope of Services, opinions or estimates of probable construction cost are prepared on the basis of NOREX'S experience and qualifications and represent NOREX'S judgment as a professional generally familiar with the industry. NOREX shall use its best professional efforts to prepare such opinions or estimates of probable construction costs in accordance with CLIENT's budget. However, since NOREX has no control over the cost of labor, materials, equipment, or services furnished by others, NOREX cannot and does not guarantee that proposals, bids, or actual construction cost will not vary from opinions or estimates of probable construction cost.
6. **STANDARD OF CARE:** The standard of care for all professional engineering and related Services performed or furnished by NOREX under this proposal/agreement will be the care and skill ordinarily used by members of the subject profession practicing under similar circumstances at the same time and in the same locality. NOREX makes no warranties express or implied, under this proposal/agreement or otherwise, in connection with the Services. Norex conveys no express or implied warranties or guarantees concerning any and all results that may occur if and when Norex professional advice and/or recommendations are acted upon by the client; said acts being outside the direct and total control of NOREX. NOREX may retain such consultants as NOREX deems necessary to assist in the performance or furnishing of the Services, subject to reasonable, timely, and substantive objections by CLIENT. NOREX does not provide legal advice. Nothing in this proposal/agreement or in the work product derived here from should be regarded as legal advice. NOREX recommends the use of legal counsel on all issues dealing with federal, state or local regulations.
7. **DESIGN WITHOUT CONSTRUCTION PHASE SERVICES:** If NOREX'S Services under this proposal/agreement do not include Project observation, or review of the contractor's performance, or any other construction phase services, then:
- a. NOREX'S Services under this proposal/agreement shall be deemed complete upon the final approvals of Final Plans and Specifications;
 - b. NOREX shall have no alternate materials, product evaluation, equipment, submittal or shop drawing review obligations during construction;
 - c. CLIENT assumes all responsibility for the application and interpretation of the contract documents, contract administration, construction observation and review, and all other necessary construction phase engineering services; and
 - d. CLIENT waives any claims against NOREX that may be connected in any way thereto.
8. **OWNERSHIP OF DOCUMENTS:** All data, reports, drawings, specifications, record drawings and other deliverables prepared (regardless of format) or furnished by NOREX pursuant to this proposal/agreement (collectively, the "Documents") are instruments of NOREX'S professional Service, and NOREX shall retain an ownership and property interest therein, including the copyright and the right of reuse at the sole and absolute discretion of NOREX, whether or not the Project is completed. CLIENT shall not rely in any way on any Document unless it is signed or sealed by NOREX. NOREX grants CLIENT a license to use such signed or sealed Documents for the purpose of

constructing, occupying, and maintaining the Project. CLIENT agrees not to reuse or modify any Documents without NOREX'S written permission. Any such use or reuse, or any modification of the Document, without written verification, completion, or adaptation by NOREX, as appropriate for the specific purpose intended, shall be at CLIENT'S sole risk and without liability or legal exposure to NOREX or to its officers, directors, employees, partners, agents and representative.

Copies of Documents that may be relied upon by CLIENT are limited to copies that are signed and sealed by NOREX. When transferring Documents in electronic media format, NOREX makes no representations as to long-term compatibility, usability, or read-ability of documents resulting from the use of software application packages, operating systems or computer hardware differing from those in use by NOREX at the effective date of this proposal/agreement.

9. **INSURANCE:** NOREX maintains Commercial General Liability Insurance, and Professional Liability Insurance and shall deliver to CLIENT a copy of Certificate of Insurance evidencing coverage upon request.
10. **TERMINATION OF AGREEMENT:** This proposal/agreement may be terminated by NOREX or CLIENT by providing seven (7) days written notice to the other party. In the event of such termination, NOREX agrees to provide the appropriate work completed to date to CLIENT, and CLIENT agrees to remit payment to Norex for all fees and expenses due, up to the date of the termination.
11. **CONTROLLING LAW:** This proposal/agreement and the legal relations between the parties shall be governed by and construed in accordance with the laws of the State of Texas without regard to its conflicts of law principles.
12. **SUCCESSORS AND ASSIGNS:** Neither Party may assign, sublet or transfer any rights under or interest in this proposal/agreement without the prior written consent of the other. Unless specifically stated to the contrary in any written consent to assignment, no assignment will release or discharge the assignor from any duty or responsibility under this proposal/agreement.
13. **DISPUTE RESOLUTION: MEDIATION.** CLIENT and NOREX agree that they shall first submit any and all unsettled claims, counterclaims, disputes, and other matters in question between them arising out of or relating to this proposal/agreement or the breach thereof ("Disputes") to mediation by Mediator or Mediation service. If such mediation is unsuccessful in resolving a Dispute, then (a) the parties may mutually agree to a dispute resolution of their choice, or (b) either party may seek to have the Dispute resolved by a court of competent jurisdiction.
14. **INDEMNIFICATION AND MUTUAL WAIVER:**
 - a. Indemnification by NOREX: NOREX shall indemnify and hold CLIENT, and its respective officers, directors, employees, partners, agents and representatives, harmless from and against any and all claims, costs, losses, damages and expenses (including, without limitation, all reasonable fees and charges of architects, engineers, attorneys and other professionals, all court, arbitration or other dispute resolution costs) arising out of or relating to the services, provided that any such claim, cost, loss, damage and expense is attributable to bodily injury, sickness, disease, or death, or to damage to or destruction of tangible property, including to the extent such claims, costs, losses, damages, and expenses are caused by NOREX'S negligent acts, errors or omissions.

- b. Indemnification by CLIENT: CLIENT shall indemnify and hold NOREX harmless, and its respective officers, directors, employees, partners, agents and representatives, from and against any and all claims, costs, losses, damages and expenses (including, without limitation, all reasonable fees and charges of architects, engineers, attorneys and other professionals, all court, arbitration or other dispute resolution costs) arising out of or relating to: (i) the Project, provided that any such claim, cost, loss, damage and expense is attributable to bodily injury, sickness, disease, or death or to damage to or destruction of tangible property, including to the extent such claims, costs, losses, damages, and expenses are caused by CLIENT's negligent acts, error or omissions (ii) the condition of any real property (together with any improvements thereon) owned or controlled by CLIENT, including, without limitation, the presence on such property of any substance, product, waste or other material of any nature whatsoever which is listed, regulated or addressed pursuant to any federal, state or local statute, law, rule, regulation, ordinance, resolution, code, order or decree, (iii) the reuse or modification of any Document by CLIENT or any other entity or individual acting by or through CLIENT.
- c. Joint or Contributory Negligence: To the fullest extent permitted by law, a Party's total liability to the other party and anyone claiming by, through or under the other party for any claim, cost, loss, damage or expense, caused in part by the negligence of the party and in part by the negligence of the other party, or any other negligent entity or individual shall not exceed the allocable percentage share that the party's negligence bears to the total negligence of CLIENT, NOREX and all other negligent entities and individuals.
- d. Mutual Waiver of Certain Damages: To the fullest extent permitted by law, the parties here to waive against each other and the other officers, directors, employees, partners, agents and representatives, any and all claims for or entitlement to special, incidental, indirect, punitive or consequential damages arising out of, resulting from, or in any way related to the Project.

15. MISCELLANEOUS PROVISIONS:

- a. Survival: All express representation, waiver, indemnifications, and limitations of liability included in this proposal/agreement will survive its completion or termination for any reason.
- b. Severability: Any provision or part of the proposal/agreement held to be voided or unenforceable under any applicable laws or regulations shall be deemed stricken and all remaining provisions shall continue to be valid and binding upon the Parties, who agree that the proposal/agreement shall be reformed to replace such stricken provision or part thereof with a valid and enforceable provision that comes as close as possible to expressing the intention of the stricken provision.

4605 PECK AVENUE (RUNGE PARK CONCESSIONS STANDS)

ON-SITE SEWAGE FACILITY PLANS
FOR PROPOSED MODIFIED AEROBIC SEPTIC DRIP DISPOSAL SYSTEM
LOCATED WITHIN GALVESTON COUNTY, TEXAS

DRAWING INDEX

- S-0 COVER SHEET
- S-1 AERIAL VIEW
- S-2 ENLARGED VIEWS & DESIGN BASIS
- S-2-0 ENLARGED DISPOSAL FIELD VIEW & ENLARGED SEPTIC TANK VIEW
- S-2-1 DESIGN BASIS PG 1 OF 2
- S-2-2 DESIGN BASIS PG 2 OF 2
- S-3 TANK DIAGRAMS
- S-3-0 EXISTING TANK DIAGRAMS
- S-3-1 PROPOSED TANK DIAGRAMS
- S-4 PUMP CURVE
- S-5 FEMA MAP
- S-6 OSSF SOIL & SITE SURVEY (PGs 1-3)

VICINITY MAP



ENGINEER: MICHAEL SCANLON
 LICENSE #: 72082
 FIRM: NOREX ENGINEERING, INC.
 FIRM ADDRESS: 1220 E. MAIN ST., LEAGUE CITY, TX 77573
 FIRM #: F-4003
 PHONE #: (281) 474-2640
 PROJECT OWNER: GALVESTON COUNTY PARKS DEPARTMENT
 DATE: 07/01/2022

OWNER INFORMATION
 NAME: GALVESTON COUNTY PARKS DEPARTMENT
 PHONE #: (409) 443-4232 - Jimmy Gibson
 EMAIL: Jimmy.Gibson@Co.Galveston.TX.US
 ADDRESS: 2222 28th Street, Galveston, Texas 77550

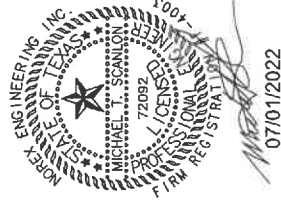

EXPIRATION NOTICE:
 THESE DOCUMENTS ARE ONLY VALID WITHIN ONE YEAR (365 DAYS) OF THE STAMP DATE. ONCE EXPIRED, THESE DOCUMENTS MUST BE REVIEWED BY NOREX ENGINEERING, INC. TO VERIFY EXISTING SITE CONDITIONS AND COMPLIANCE WITH APPLICABLE CODES.

COPYRIGHT:
 THIS DOCUMENT AND THE DESIGNS INCORPORATED HEREIN ARE NOT TO BE USED OR COPIED IN WHOLE OR IN PART FOR ANY OTHER PROJECTS OR PURPOSES WITHOUT THE EXPRESS WRITTEN AUTHORIZATION OF NOREX ENGINEERING, INC.

DISCLAIMER:
 NOREX ENGINEERING DISCLAIMS ANY RESPONSIBILITY FOR THE ADEQUACY OF THE DESIGN SPECIFIED IN THIS DOCUMENT. THE USER HAS SUCCESSFULLY COMPLETED ALL NECESSARY CONSTRUCTION INSPECTIONS AND RECEIVED THE ENGINEER'S CERTIFICATION.

110 1 10 1440.dwg Client:Park800 Peck, Commercial 06/29/20-4605 Peck, Sheet (Commercial-Dwg), Rev=01-01-2022.dwg July 01, 2022 04:23pm

COVER SHEET - SHEET S-0

Norex Engineering	TEL: (281) 474-2640	FAX: (281) 474-2748
CLIENT	GALVESTON COUNTY PARKS DEPARTMENT 1220 East Main St., League City, Texas, 77573	
STREET	1220 E. MAIN ST., LEAGUE CITY, TEXAS 77573	
CITY, STATE, ZIP	LEAGUE CITY, TEXAS 77573	
CHECK BY: WAS	DATE: 05/29/2022	DESIGN BY: SMH
	SCALE: 1"=40'	SHEET: 001 OF 001

100-YEAR FLOOD PLAIN: (NO) AS SHOWN ON FEMA MAP IF APPLICABLE.
 TOPOGRAPHY: FLAT (UNDER 2%)
 EXISTING TANKS: (YES) AS SHOWN ON DRAWING IF APPLICABLE.
 WATER WELLS: ALL KNOWN WATER WELLS LOCATIONS WITHIN 150' OF THE PROPERTY ARE AS SHOWN ON DRAWING, UNO.

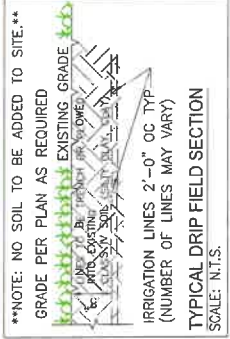

LEGEND

--- (dashed line)	UTILITY EASEMENT
— (solid line)	PROPERTY LINE
— (dotted line)	PROPERTY BUFFER
— (dashed line)	DISPOSAL BOUNDARY
— (solid line)	SEWER LINE
— (dashed line)	WATER WELL
— (solid line)	WATER LINE
— (dashed line)	FENCE LINE
→ (arrow)	SITE DRAINAGE DIRECTION
○ (circle)	BORE HOLES
— (solid line)	1" PURPLE SUPPLY LINE
— (dashed line)	1" PURPLE RETURN LINE

EXPIRATION NOTICE:
 THESE DOCUMENTS ARE ONLY VALID WITHIN ONE YEAR (365 DAYS) OF THE STAMP DATE. ONCE EXPIRED, THESE DOCUMENTS MUST BE REVIEWED BY NOREX ENGINEERING, INC. TO VERIFY EXISTING SITE CONDITIONS AND COMPLIANCE WITH APPLICABLE CODES.
 COPYRIGHT:
 THIS DOCUMENT AND THE DESIGNS INCORPORATED HEREIN ARE NOT TO BE USED OR COPIED IN WHOLE OR IN PART FOR ANY OTHER PROJECTS OR PURPOSES WITHOUT THE EXPRESS WRITTEN AUTHORIZATION OF NOREX ENGINEERING, INC.
 DISCLAIMER:
 NOREX ENGINEERING DISCLAIMS ANY RESPONSIBILITY FOR THE ADEQUACY OF THE DESIGN DEPICTED IN THIS DRAWING UNTIL IT HAS SUCCESSFULLY COMPLETED ALL NECESSARY CONSTRUCTION INSPECTIONS AND RECEIVED THE ENGINEER'S CERTIFICATION.
 IN MY PROFESSIONAL OPINION, THIS SYSTEM CAN BE OPERATED WITHOUT CAUSING A THREAT OR HARM TO ANY EXISTING OR PROPOSED WATER SUPPLY SYSTEM OR TO THE PUBLIC HEALTH, OR CAUSING THE THREAT OF POLLUTION OR NUISANCE CONDITIONS.

I, MICHAEL SCARLON, A REGISTERED PROFESSIONAL ENGINEER AUTHORIZED TO PRACTICE IN THE STATE OF TEXAS DO HEREBY CERTIFY THAT THE SEPTIC SYSTEM FOR THE EXISTING RUNGE BALL PARK RESTROOMS & CONCESSIONS SINK IF CONSTRUCTED OR PLACED IN ACCORDANCE WITH THESE DRAWINGS WILL COMPLY WITH ALL PROVISIONS OF THE REGULATIONS OF GALVESTON COUNTY, TEXAS FOR FLOOD PLAIN MANAGEMENT.
AERIAL VIEW - SHEET S-1

Norex Engineering
 1220 East Main St. League City, Texas 77573
 TEL: (281) 474-2640 FAX: (281) 474-2748
 CLIENT: GALVESTON COUNTY PARKS DEPARTMENT | ERECT/DATE: 07/01/2022 | REV # | 0
 ADDRESS: 1220 EAST MAIN ST., LEAGUE CITY, TEXAS 77573
 CITY, STATE, ZIP: LEAGUE CITY, TEXAS 77573
 CHECK BY: MS | DATE: 05/09/2022 | DESIGN BY: SHH | SCALE: SEE PNG

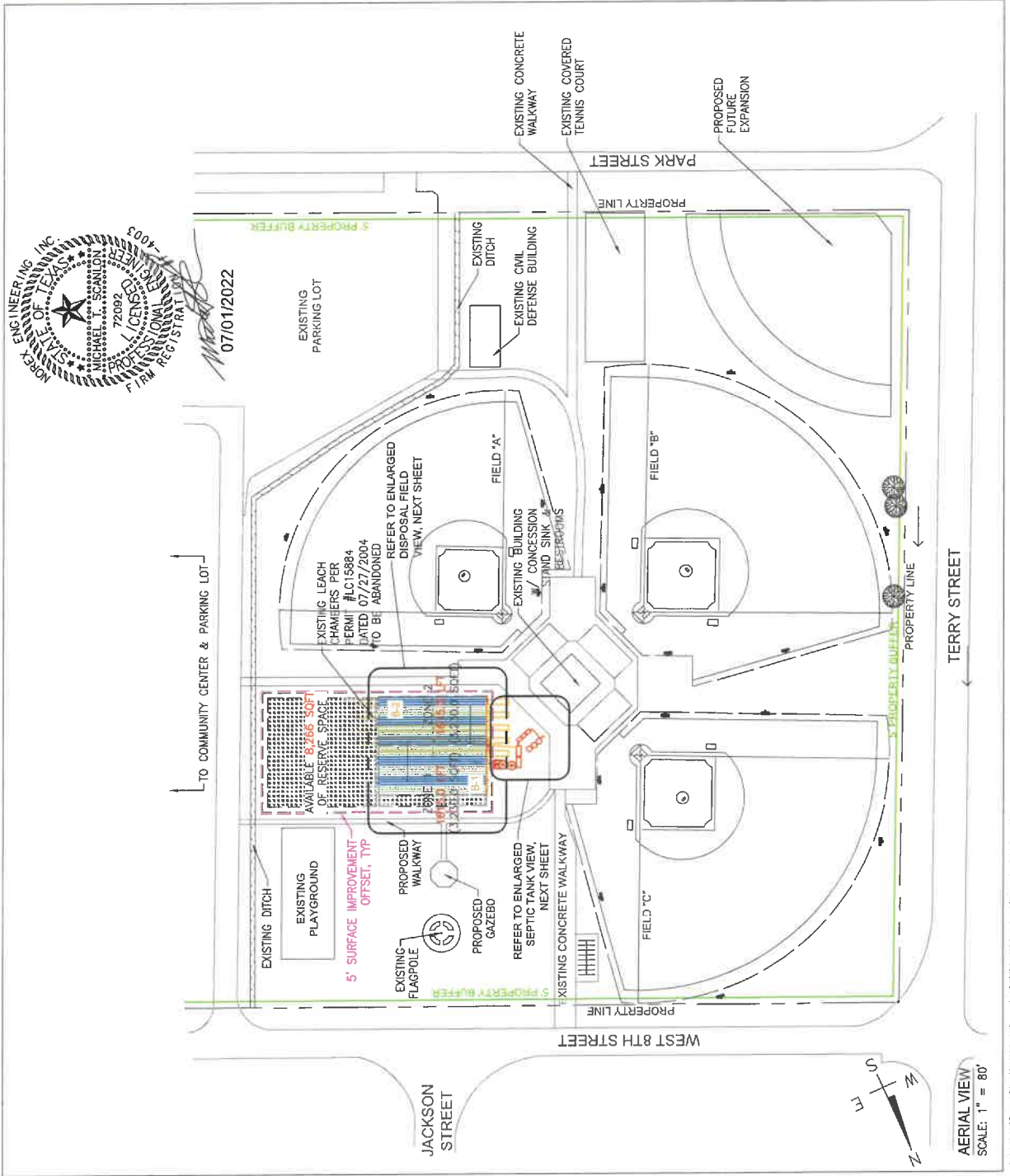

07/01/2022

AERIAL VIEW
 SCALE: 1" = 80'

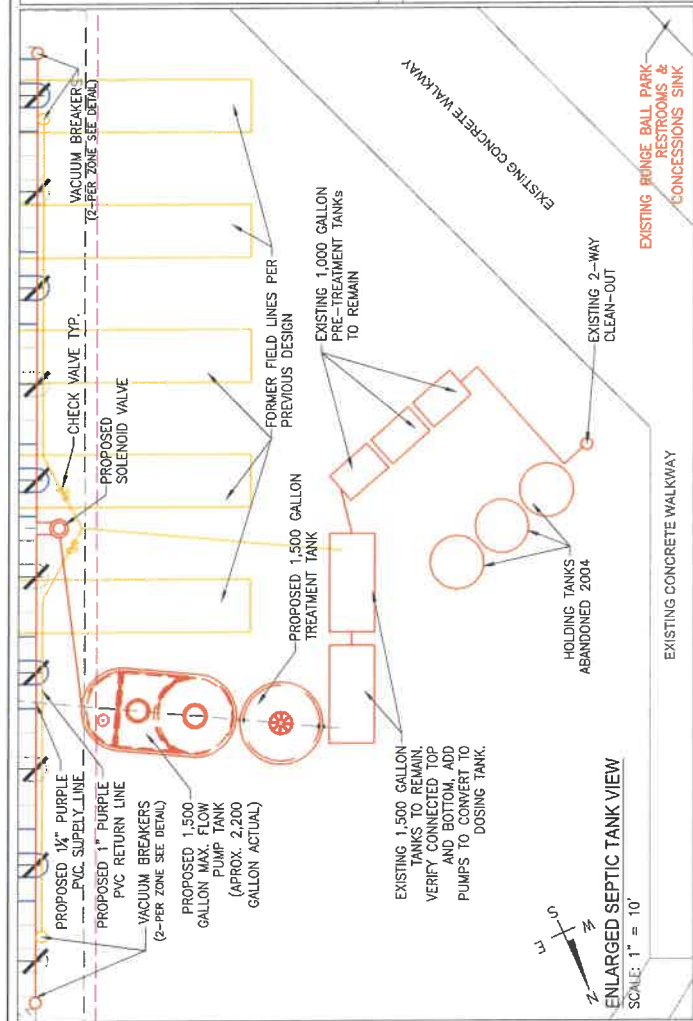
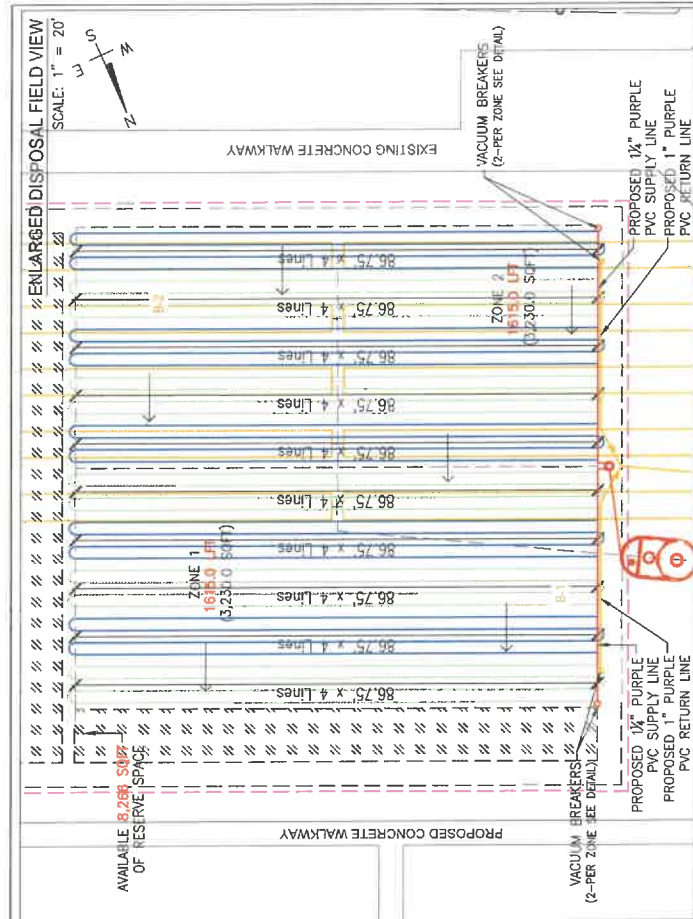

****NOTE: NO SOIL TO BE ADDED TO SITE.****
GRADE PER PLAN AS REQUIRED

IRRIGATION LINES 2'-0" OC TYP (NUMBER OF LINES MAY VARY)

TYPICAL DRIP FIELD SECTION
SCALE: N.T.S.

LEGEND

- UTILITY EASEMENT
- PROPERTY LINE
- PROPERTY BUFFER
- DISPOSAL BOUNDARY
- SEWER LINE
- WATER WELL
- WATER LINE
- FENCE LINE
- SITE DRAINAGE DIRECTION
- BORE HOLES (B-1, B-2)
- 1 1/2" PURPLE SUPPLY LINE
- 1" PURPLE RETURN LINE

EXPIRATION NOTICE: THESE DOCUMENTS ARE ONLY VALID WITHIN ONE YEAR (365 DAYS) OF THE STAMP DATE. ONCE EXPIRED, THESE DOCUMENTS MUST BE REVIEWED BY NOREX ENGINEERING, INC. TO VERIFY EXISTING SITE CONDITIONS AND COMPLIANCE WITH APPLICABLE CODES.

COPYRIGHT: THE DOCUMENT AND THE DESIGNS INCORPORATED HEREIN ARE NOT TO BE USED OR COPIED IN WHOLE OR IN PART FOR ANY OTHER PROJECTS OR PURPOSES WITHOUT THE EXPRESS WRITTEN AUTHORIZATION OF NOREX ENGINEERING, INC.

DISCLAIMER: NOREX ENGINEERING DISCLAIMS ANY RESPONSIBILITY FOR THE ADEQUACY OF THE DESIGN DEPICTED IN THIS DRAWING UNTIL IT HAS SUCCESSFULLY COMPLETED ALL NECESSARY CONSTRUCTION INSPECTIONS AND RECEIVED THE ENGINEER'S CERTIFICATION.

IN MY PROFESSIONAL OPINION, THIS SYSTEM CAN BE OPERATED WITHOUT CAUSING A THREAT OR HARM TO ANY EXISTING OR PROPOSED WATER SUPPLY SYSTEM OR TO THE PUBLIC HEALTH, OR CAUSING THE THREAT OF POLLUTION OR NUISANCE CONDITIONS.

I, MICHAEL SCANLON, A REGISTERED PROFESSIONAL ENGINEER AUTHORIZED TO PRACTICE IN THE STATE OF TEXAS DO HEREBY CERTIFY THAT THE SEPTIC SYSTEM FOR THE **EXISTING RUNGE BALL PARK RESTROOMS & CONCESSIONS SINK** IF CONSTRUCTED OR PLACED IN ACCORDANCE WITH THESE DRAWINGS WILL COMPLY WITH ALL PROVISIONS OF THE REGULATIONS OF GALVESTON COUNTY, TEXAS FOR FLOOD PLAIN MANAGEMENT.

Norex Engineering
2220 East Main St. League City, Texas 77573
TEL: (281) 474-2440 FAX: (281) 474-2748

CUSTOMER: RUNGE BALL PARK RESTROOMS & CONCESSIONS
PROJECT: WALKWAY WALKWAY
CITY/STATE/ZIP: LEAGUE CITY, TEXAS 77573
PROJECT NO.: 22-0001
DATE: 07/10/2022

DESIGN BY: [Signature]
DATE: 07/10/2022
SCALE: SEE TAG

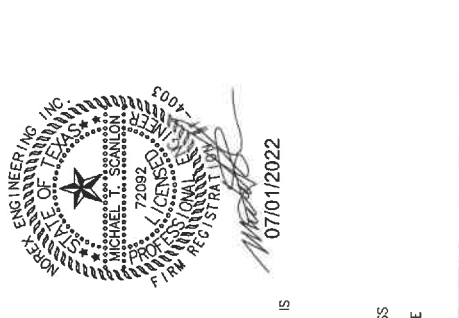

- 10-YEAR FLOOD PLAIN: (NO) AS SHOWN ON FEMA MAP IF APPLICABLE.
TOPOGRAPHY: (YES) AS SHOWN ON DRAWING IF APPLICABLE.
EXISTING TANKS: (YES) AS SHOWN ON DRAWING WITHIN 150' OF WATER WELLS: ALL KNOWN WATER WELLS LOCATIONS WITHIN 150' OF THE PROPERTY ARE AS SHOWN ON DRAWING, U.N.O.
- VACUUM BREAKER DETAIL**
-
- VACUUM BREAKERS (TYP.)
- RETURN LINE
- CHECK VALVE
- SUPPLY LINE
- GENERAL NOTES:
1. CONTRACTOR TO UTILIZE FLEX CONNECTORS AT ALL SUPPLY AND RETURN CONNECTIONS.
 2. SUPPLY LINE MANIFOLD TO BE 6" HIGHER THAN RETURN LINE MANIFOLD.
 3. AUTOMATIC FLUSH-SOLENOID VALVE CAN BE INSTALLED ON RETURN LINE IN LIEU OF BALL VALVE.
 4. AUTOMATIC PRESSURE REGULATOR MAY BE UTILIZED IN LIEU OF GATE VALVE FOR PRESSURE AND FLOW CONTROL TO DISPOSAL FIELD.
 5. PER TCEQ RULES RETURN FLUSH LINE TO PRE-TREATMENT OR PUMP TANKS DEPENDING ON FLUSH METHOD UTILIZED.
 6. USE A K-RAIN SOLENOID VALVE OR EQUAL WITH MULTI-ZONE SYSTEMS.
 7. ALL EMITTER LINES TO BE PRESSURE COMPENSATED **NETAFUN-BOLINE** POLYETHYLENE TUBING OR EQUAL. THIS IS A SITE SPECIFIC DESIGN TAKING INTO CONSIDERATION SOIL TYPE, GROUND WATER, AND TOPOGRAPHY AND IS SUITABLE FOR OPERATION IN THE ENVIRONMENT.
- SITE SPECIFIC NOTES:**
1. INSTALL LOW FLOW TOILET AND BATHROOM FIXTURES.
 2. TILL IN A MIN. CLASS II SOIL (SANDY LOAM, LOAM). PLACE IRRIGATION LINES OVER SOIL. THEN COVER WITH NEW TOP SOIL/CARPET GRASS. FINISH GRADE TO GROWN SLIGHTLY IN CENTER (SEE TYPICAL DRIP FIELD CROSS SECTION).
 3. DRAINAGE SHALL BE PROVIDED AS SHOWN. HOME BUILDER SHALL ENSURE NO STANDING WATER AND ADEQUATE DRAINAGE.

FIG 11.18 (General Chem/H465) Pict (Commercial) 08/8/14-2015 Pict Sheet (Commercial-Eng) 1/28/21, 2022-04-30



DESIGN BASIS:
 OSSF DESIGNED FOR THE FOLLOWING (Q):
EXISTING RUNGE BALL PARK WITH RESTROOMS & CONCESSIONS SINK ALL UTILIZING LOW FLOW FIXTURES.

FLOW RATE:
QUEUE 1 (M-MENS)
 2. RESTROOM STALLS (1 TOILET & 1 URINAL - BOTH EXISTING) EACH WITH
 2.0 GALLONS (1.5 TOILET + 0.5 SINK) EVERY 10 MINUTES FOR 8 HOURS/DAY PER 3 DAYS/WEEK. (FRI-SAT-SUN)
 ((1 STALL x 2 GALLONS x (8 HR/DAY x 60 MIN./HR) + 10 MIN./USE) = 96 GPD
 2.0 GALLONS (1.5 TOILET + 0.5 SINK) EVERY 40 MINUTES FOR 8 HOURS/DAY PER 4 DAYS/WEEK. (MON-TUE-WED-THUR)
 ((1 STALL x 2 GALLONS x (8 HR/DAY x 60 MIN./HR) + 40 MIN./USE) = 24 GPD
AND
 1.8 GALLONS (1.3 URINAL + 0.5 SINK) EVERY 3 MINUTES FOR 8 HOURS/DAY PER 3 DAYS/WEEK. (FRI-SAT-SUN)
 ((1 STALL x 1.8 GALLONS x (8 HR/DAY x 60 MIN./HR) + 3 MIN./USE) = 288 GPD
 1.8 GALLONS (1.3 URINAL + 0.5 SINK) EVERY 12 MINUTES FOR 8 HOURS/DAY PER 4 DAYS/WEEK. (MON-TUE-WED-THUR)
 ((1 STALL x 1.8 GALLONS x (8 HR/DAY x 60 MIN./HR) + 12 MIN./USE) = 72 GPD
 [(96 GPD + 288 GPD)] = 384 GPD FRIDAY-SATURDAY-SUNDAY
 [(24 GPD + 72 GPD)] = 96 GPD MONDAY-TUESDAY-WEDNESDAY-THURSDAY
 [(384 GPD) x 3 DAYS/WEEK] + [(96 GPD) x 4 DAYS/WEEK] = 1,536 GPD
AND
 QUEUE 2 (WOMENS)
 2. RESTROOM STALLS (2 TOILET STALLS - BOTH EXISTING) EACH WITH
 2.0 GALLONS (1.5 TOILET + 0.5 SINK) EVERY 10 MINUTES FOR 8 HOURS/DAY PER 3 DAYS/WEEK. (FRI-SAT-SUN)
 ((2 STALLS x 2 GALLONS x (8 HR/DAY x 60 MIN./HR) + 5 MIN./USE) = 384 GPD
 2.0 GALLONS (1.5 TOILET + 0.5 SINK) EVERY 40 MINUTES FOR 8 HOURS/DAY PER 4 DAYS/WEEK. (MON-TUE-WED-THUR)
 ((2 STALLS x 2 GALLONS x (8 HR/DAY x 60 MIN./HR) + 20 MIN./USE) = 96 GPD
 [(384 GPD)] = 384 GPD FRIDAY-SATURDAY-SUNDAY
 [(96 GPD)] = 96 GPD MONDAY-TUESDAY-WEDNESDAY-THURSDAY
 [(384 GPD) x 3 DAYS/WEEK] + [(96 GPD) x 4 DAYS/WEEK] = 1,536 GPD
AND
 QUEUE 3 (CONCESSIONS SINK)
 3 SINKS (ALL EXISTING) EACH WITH
 CAPACITY OF EACH SINK 15 IN X 15 IN X 14 IN = 3150 CU. IN. [(3150 CU. IN.) ÷ 231] = 13.6 GPM
 ADJUSTMENT FOR DISPLACEMENT: (13.6 GPM) x 0.75 = 10.2 GPM REQUIRED TO DRAIN SINK IN ONE MINUTE.
 SIZING FOR MULTIPLE FIXTURES (REDUCTION)
 FIXTURE A: 10.2 GPM x 100% = 10.2 GPM
 FIXTURE B: 10.2 GPM x 50% = 5.1 GPM
 FIXTURE C: 10.2 GPM x 25% = 2.6 GPM
 TOTAL FLOW RATE = 17.9 GPM
 17.9 GPM FOR 10 MINS. EVERY 1 HOUR FOR 4 HOURS/DAY PER 3 DAYS/WEEK. (FRI-SAT-SUN) CLOSED EVERY OTHER DAY
 [(17.9 GPM x 10 MIN./HR) x 4 HR/DAY] = 716 GPD
 [(716 GPD)] = 716 GPD FRIDAY-SATURDAY-SUNDAY
 [(716 GPD) x 3 DAYS/WEEK] = 2,148 GPD
 [(384) + (384) + (716) = 1,484 GPD. PEAK DAY FRIDAY-SATURDAY-SUNDAY
 [(96) + (96) + (0) = 192 GPD OFF-PEAK DAY MONDAY-TUESDAY-WEDNESDAY-THURSDAY
 [(1536) + (1536) + (2148) = 5220 GPM] = 5220 GPM] = 5,000 GPD EXCEEDING THE CALCULATED DESIGN (Q) = 746 GPD AVERAGE
 THE DESIGN (Q) USED FOR THIS DESIGN WILL BE 1,000 GPD EXCEEDING THE CALCULATED MINIMUM AVERAGE 746 GPD
 PROPOSED DOSING TO AEROBIC TREATMENT UNIT SCHEDULE
 (1,000 GPD) + (24 DOSING/24 HR) = 41.6 GALLONS PER DOSE
 PROPOSED DISPOSAL SYSTEM - TREATED WATER DRIP IRRIGATION SYSTEM
 APPLICATION RATE = 0.2 GAL/SOFT/DAY
 DISPOSAL AREA REQUIRED (DESIGN (Q) = 1000 GPD) + 0.2 (GAL/SOFT/DAY) = 5,000 SOFT
 EMITTER LINE REQUIRED (DESIGN (Q) = 5,000 (SOFT) ÷ 2 (FT) = 2,500 LFT
 DISPOSAL AREA PROVIDED = 6,940 SOFT
 EMITTER LINE PROVIDED = 6,940 (SOFT) ÷ 2 (FT) = 3,470 LFT
 REQUIRED RESERVE SPACE FOR "DOUBLING" PER TCEQ "FOOD SERVICE ESTABLISHMENT"
 ADDITIONAL "DOUBLING" AREA REQUIRED = 5,000 RESERVE SOFT
 TOTAL DISPOSAL AREA REQUIRED INCLUDING RESERVE = (5,000 SOFT) + (5,000 RESERVE SOFT) = 10,000 SOFT
 TOTAL DISPOSAL AREA PROVIDED INCLUDING RESERVE = (6,940 SOFT) + (8,266 RESERVE SOFT) = 15,206 SOFT
 BASED ON DESIGN HYDRAULIC LOADING RATE OF 0.2 GAL/SOFT/DAY:
 NEXAM BIOLINE SUBSURFACE DRIP LINE
 EMITTER SPACING AT 24" O.C. (0.6 GPH)
 ZONE 1 = 1,735.0 LFT (3,470.0 SOFT)
 ZONE 2 = 1,735.0 LFT (3,470.0 SOFT)
 TOTAL EFFECTIVE DISPOSAL AREA ALL ZONES = 3,470.0 LFT (6,940.0 SOFT)
 NTS 11.1146General ChemWatersProc (Commercial ODS910-4005 Peak Boreal (Commercial-Eng)_Rev03-01-2022.dwg Job 01-2022-04-30m

PUMP CALCULATION / PROPOSED IRRIGATION RATE (GPM) - DRIP SYSTEM:
 PER EMITTER (0.6 GPH) WITH SPACING AT 24" ON CENTER
 ADJUST OPERATING PRESSURE (PSI) DOWNWARD WITH USE OF FLOW CONTROL VALVE AS NEEDED.
 ZONE 1
 LATERAL 1 = 347.00 LFT/2 = 174 EMITTERS (174 EMITTERS X 0.6 GPH/60 MIN = 1.74 GPM)
 LATERAL 2 = 347.00 LFT/2 = 174 EMITTERS (174 EMITTERS X 0.6 GPH/60 MIN = 1.74 GPM)
 LATERAL 3 = 347.00 LFT/2 = 174 EMITTERS (174 EMITTERS X 0.6 GPH/60 MIN = 1.74 GPM)
 LATERAL 4 = 347.00 LFT/2 = 174 EMITTERS (174 EMITTERS X 0.6 GPH/60 MIN = 1.74 GPM)
 LATERAL 5 = 347.00 LFT/2 = 174 EMITTERS (174 EMITTERS X 0.6 GPH/60 MIN = 1.74 GPM)
 TOTAL GPM FOR ALL ZONE 1 LATERALS = 8.7 GPM
 TOTAL GPM W/2.0FPS FLUSHING VELOCITY = (8.7) + (1.6 x # OF LATERALS (5) = 8.0) = 16.7 GPM
 ZONE 2
 LATERAL 1 = 347.00 LFT/2 = 174 EMITTERS (174 EMITTERS X 0.6 GPH/60 MIN = 1.74 GPM)
 LATERAL 2 = 347.00 LFT/2 = 174 EMITTERS (174 EMITTERS X 0.6 GPH/60 MIN = 1.74 GPM)
 LATERAL 3 = 347.00 LFT/2 = 174 EMITTERS (174 EMITTERS X 0.6 GPH/60 MIN = 1.74 GPM)
 LATERAL 4 = 347.00 LFT/2 = 174 EMITTERS (174 EMITTERS X 0.6 GPH/60 MIN = 1.74 GPM)
 LATERAL 5 = 347.00 LFT/2 = 174 EMITTERS (174 EMITTERS X 0.6 GPH/60 MIN = 1.74 GPM)
 TOTAL GPM FOR ALL ZONE 2 LATERALS = 8.7 GPM
 TOTAL GPM W/2.0FPS FLUSHING VELOCITY = (8.7) + (1.6 x # OF LATERALS (5) = 8.0) = 16.7 GPM
PUMP TANK DAILY DOSING SCHEDULE
 ZONE 1 = (15 MINUTES) X (8.7 GPM) X (4 CYCLES PER DAY) = 522.0 GPD
 ZONE 2 = (15 MINUTES) X (8.7 GPM) X (4 CYCLES PER DAY) = 522.0 GPD
 TOTAL GPD FOR ALL ZONES = 1044.0 GPD ÷ 1000 GPD = 104.4% OF DESIGN Q
TOTAL HEAD = REQUIRED EMITTER LINE PRESSURE HEAD + DYNAMIC HEAD
 ZONE 1 and ZONE 2
 STATIC HEAD = 5 FT
 REQUIRED EMITTER LINE PRESSURE HEAD = PSI x 2.31 = FT = 45 PSI x 2.31 = 103.95 FT
 DYNAMIC HEAD = (SUPPLY + RETURN) LINE LOSS + (SUPPLY + RETURN) FITTINGS FRICTION LOSS
 LINE LOSS SUPPLY (1/2") = (40.87 FT x 4.445)/100FT = 1.82 FT
 LINE LOSS RETURN (1") = (56.33 FT x 4.160)/100FT = 2.34 FT
 FITTINGS FRICTION LOSS SUPPLY = 1.82 FT x (0.2) = 0.36 FT
 FITTINGS FRICTION LOSS RETURN = 2.34 FT x (0.2) = 0.47 FT
 TOTAL: (1.82 + 2.34) LINE LOSS + FITTING FRICTION LOSS (0.36 + 0.47) = 4.99 FT
 TOTAL HEAD = STATIC HEAD(6) + REQ. PRESSURE HEAD(103.95) + DYNAMIC HEAD(4.99) = 114.94 FT (49.76 PSI)
 ADJUST OPERATING PRESSURE (PSI) DOWNWARD WITH USE OF FLOW CONTROL VALVE AS NEEDED.

EXPIRATION NOTICE:
 THESE DOCUMENTS ARE ONLY VALID WITHIN ONE YEAR (365 DAYS) OF THE STAMP DATE. ONCE EXPIRED, THESE DOCUMENTS MUST BE REVIEWED BY NOREX ENGINEERING, INC. TO VERIFY EXISTING SITE CONDITIONS AND COMPLIANCE WITH APPLICABLE CODES.
 COPYRIGHT:
 THIS DOCUMENT AND THE DESIGNS INCORPORATED HEREIN ARE NOT TO BE USED OR COPIED IN WHOLE OR IN PART FOR ANY OTHER PROJECTS OR PURPOSES WITHOUT THE EXPRESS WRITTEN AUTHORIZATION OF NOREX ENGINEERING, INC.
 DISCLAIMER:
 NOREX ENGINEERING DISCLAIMS ANY RESPONSIBILITY FOR THE ADEQUACY OF THE DESIGN DEPICTED IN THIS DRAWING UNTIL IT HAS SUCCESSFULLY COMPLETED ALL NECESSARY CONSTRUCTION INSPECTIONS AND RECEIVED THE ENGINEER'S CERTIFICATION.
 IN MY PROFESSIONAL OPINION, THIS SYSTEM CAN BE OPERATED WITHOUT CAUSING THE USER OR OWNER TO ANY EXISTING OR OTHER PROPOSED WASTEWATER SUPPLY SYSTEM OR TO THE PUBLIC HEALTH OR CAUSING THE THREAT OF POLLUTION OR NUISANCE CONDITIONS.
 I, MICHAEL SCANLON, A REGISTERED PROFESSIONAL ENGINEER AUTHORIZED TO PRACTICE IN THE STATE OF TEXAS DO HEREBY CERTIFY THAT THE SEPTIC SYSTEM FOR THE EXISTING RUNGE BALL PARK RESTROOMS & CONCESSIONS SINK IF CONSTRUCTED OR PLACED IN ACCORDANCE WITH THESE DRAWINGS WILL COMPLY WITH ALL PROVISIONS OF THE REGULATIONS OF GALVESTON COUNTY, TEXAS FOR FLOOD PLAIN MANAGEMENT BASIS 1 of 2 - SHEET S-2.1

GENERAL NOTES:
 1. CONTRACTOR TO UTILIZE FLEX CONNECTORS AT ALL SUPPLY AND RETURN CONNECTIONS.
 2. SUPPLY LINE MANIFOLD TO BE 6" HIGHER THAN RETURN LINE MANIFOLD.
 3. AUTOMATIC FLUSH-SOLENOID VALVE CAN BE INSTALLED ON RETURN LINE IN LIEU OF BALL VALVE.
 4. DYNAMIC PRESSURE REGULATOR MAY BE UTILIZED IN LIEU OF FIELD VALVE FOR PRESSURE AND FLOW CONTROL TO DISPOSAL SYSTEMS.
 5. PER TCEQ RULES RETURN FLUSH LINE TO PRE-TREATMENT OR PUMP TANKS DEPENDING ON FLUSH METHOD UTILIZED.
 6. USE A K-RAIN SOLENOID VALVE OR EQUAL WITH MULTI ZONE SYSTEMS.
 7. ALL EMITTER LINES TO BE PRESSURE COMPENSATED NEXAM-BIOLINE POLYETHYLENE TUBING OR EQUAL. THIS IS A SITE SPECIFIC DESIGN TAKING INTO CONSIDERATION SOIL TYPE, GROUND WATER, AND TOPOGRAPHY AND IS SUITABLE FOR OPERATION IN THE ENVIRONMENT.
 SITE SPECIFIC NOTES:
 1. INSTALL LOW FLOW TOILET AND BATHROOM FIXTURES.
 2. TILL IN A MIN. CLASS II SOIL (SANDY LOAM LOAM). PLACE IRRIGATION LINES OVER SOIL THEN COVER WITH NEW TOP SOIL/CARPET GRASS. FINISH GRADE TO CROWN SLIGHTLY IN CENTER (SEE TYPICAL DRIP FIELD CROSS SECTION). HOME BUILDER SHALL DRIP LINES SHALL BE PROVIDED AS FOLLOWS: HOME BUILDER SHALL ENSURE NO STANDING WATER AND ADEQUATE DRAINAGE.

CLIENT: GALVESTON COUNTY PARKS DEPARTMENT
PROJECT: 1220 East Main St. League City, Texas 77573
CITY: LEAGUE CITY, TEXAS
DATE: 05/10/2022
DESIGNER BY: SMH
SCALE: SEE DWG
CHECK BY: MS
DATE: 05/10/2022
DESIGNER BY: SMH
SCALE: SEE DWG
CLIENT: NOREX ENGINEERING
PROJECT: 1220 East Main St. League City, Texas 77573
CITY: LEAGUE CITY, TEXAS
DATE: 07/10/2022
DESIGNER BY: SMH
SCALE: SEE DWG
CHECK BY: MS
DATE: 07/10/2022
DESIGNER BY: SMH
SCALE: SEE DWG

100-YEAR FLOOD PLAIN: (NO AS SHOWN ON FEMA MAP IF APPLICABLE)
 TOPOGRAPHY: FLAT (UNDER 2%)
 EXISTING TANKS: (YES) AS SHOWN ON DRAWING IF APPLICABLE.
 WATER WELLS: ALL KNOWN WATER WELLS LOCATIONS WITHIN 150' OF
 THE PROPERTY ARE AS SHOWN ON DRAWING, L.I.N.O.

TOTAL HEAD =
 STATIC HEAD + REQUIRED EMITTER LINE PRESSURE HEAD + DYNAMIC HEAD
 DOSING TANK
 STATIC HEAD = 6FT
 REQUIRED LINE PRESSURE HEAD = PSI x 2.31 = FT = 3 PSI x 2.31 = 6.93 FT
 DYNAMIC HEAD = (SUPPLY + RETURN) LINE LOSS + (SUPPLY + RETURN) FITTINGS FRICTION LOSS
 LINE LOSS (1/2") = (10 FT x 4.445)/100FT = 0.45 FT
 FITTINGS FRICTION LOSS = 1.82 FT x (0.2) = 0.36 FT
 TOTAL: (0.45) LINE LOSS + FITTING FRICTION LOSS (0.36) = 0.81 FT
 TOTAL HEAD = STATIC HEAD(6) + REQ. PRESSURE HEAD(6.93) + DYNAMIC HEAD(0.81) = 13.74 FT (5.94 PSI)

BIOCHEMICAL OXYGEN DEMAND, BOD:
 PER ESTIMATED SEWAGE STRENGTH* (TCOEO Does not provide BOD/Commercial Loading)
 TCOE Page 29 (2) other high-strength sewage. For situations where sewage as defined in this chapter is expected to be a higher strength than residential sewage, it is the responsibility of the architectural/drafting to justify sewage strength estimations and properly design a system that reduces the wastewater strength to 140mg/L BOD prior to disposal unless secondary treatment levels are required. Residential sewage is sewage that has a strength of less than 300mg/L BOD.

1000 GPD @ 600 mg/L (TOILET WASTE ONLY) = 4.99 LBS/DAY
 BOD REDUCTION PRIOR TO AEROBIC TREATMENT:
 EFFLUENT WILL UNDERGO A MINIMUM OF 24 HOURS OF HYDRAULIC RETENTION TIME (HRT) BEFORE ENTERING THE ATU. THE HRT WILL REDUCE THE BOD BY A MINIMUM OF 50% PRIOR TO AEROBIC TREATMENT.
 PRIMARY TREATMENT (HYDRAULIC RETENTION)
 BASED ON PRE-TREATMENT TANK CAPACITY OF 6,000 GALLONS
 (6,000 GAL ÷ 746 GAL/DAY) = 6.00 DAYS OF RETENTION (6.00 Days x 24hrs = 144.0 hrs)
 24 HRS = 50% REDUCTION IN BOD. - 48 HRS = 55% REDUCTION IN BOD
 60 HRS = 60% REDUCTION IN BOD - 72 HRS = 65% REDUCTION IN BOD
 4.99 LBS/DAY x 0.5 (50% REDUCTION) = 2.49 LBS/DAY [Concentration=500.00 mg/L]

TREATMENT CAPACITY:
 PROPOSED AEROBIC TREATMENT UNIT (ATU): CLEARSTREAM 1500N (3.75 LBS BOD/DAY)
 TOTAL DAILY DESIGN (Q): 1,000 GPD
 CLEARSTREAM 1500N WILL TREAT 1,500 GPD AT 300mg/L PER TANK
 TOTAL DAILY Q TREATMENT CAPACITY = 1,500 GPD ÷ 1,000 GPD REQ. = 1150.0% OF TOTAL DAILY Q
 TOTAL DAILY SYSTEM BOD ENTERING ATU: 2.49 LBS/DAY
 CLEARSTREAM 1500N WILL TREAT 3.75 LBS/DAY AT 300mg/L PER TANK
 TOTAL BOD TREATMENT CAPACITY = 3.75 LBS/DAY ÷ 2.49 LBS/DAY REQ. = 150.6% OF TOTAL DAILY SYSTEM BOD

TREATMENT TANK DOSING SCHEDULE	RESTROOMS (± STALLS)	GAL/DAY	CONCESSION SINK (± URIN)	GALLONS OUT	TOTAL FOR DAY	
					GAL	REMAINING
FRIDAY	768	716	716	1000.0	1484	484.0
SATURDAY	768	716	716	1000.0	1484	988.0
SUNDAY	768	716	716	1000.0	1484	1452.0
MONDAY	192	0	0	1000.0	192	644.0
TUESDAY	192	0	0	1000.0	192	0.0
WEDNESDAY	192	0	0	1000.0	192	0.0
THURSDAY	192	0	0	1000.0	192	0.0
TOTAL GALLONS REMAINING					0	

- GENERAL NOTES:
 1. CONTRACTOR TO UTILIZE FLEX CONNECTORS AT ALL SUPPLY AND RETURN CONNECTIONS.
 2. SUPPLY LINE MAINFOLD TO BE 6" HIGHER THAN RETURN LINE MAINFOLD.
 3. AUTOMATIC FLUSH-SOLENOID VALVE CAN BE INSTALLED ON RETURN LINE IN LIEU OF BALL VALVE.
 4. AUTOMATIC PRESSURE REGULATOR MAY BE UTILIZED IN LIEU OF GATE VALVE FOR PRESSURE AND FLOW CONTROL TO DISPOSAL FIELD.
 5. PER TCOE RULES RETURN FLUSH LINE TO PRE-TREATMENT OR PUMP TANKS DEPENDING ON FLUSH METHOD UTILIZED.
 6. USE A K-RAIN SOLENOID VALVE OR EQUAL WITH MULTI ZONE SYSTEMS.
 7. ALL EMITTER LINES TO BE PRESSURE COMPENSATED
 NETAFIM-BIOLINE POLYETHYLENE TUBING OR EQUAL. THIS IS A SITE SPECIFIC DESIGN TAKING INTO CONSIDERATION SOIL TYPE, GROUND WATER, AND TOPOGRAPHY AND IS SUITABLE FOR OPERATION IN THE ENVIRONMENT.
 SITE SPECIFIC NOTES:
 1. INSTALL LOW FLOW TOILET AND BATHROOM FIXTURES.
 2. TILL IN A MIN. CLASS II SOIL (SANDY LOAM, LOAM). PLACE IRRIGATION LINES OVER SOIL THEN COVER WITH NEW TOP SOIL/CARPET GRASS. FINISH GRADE TO CROWN SLIGHTLY IN CENTER (SEE TYPICAL DRIP FIELD CROSS SECTION). DRAINAGE SHALL BE PROVIDED AS SHOWN HOME BUILDER SHALL ENSURE NO STANDING WATER AND ADEQUATE DRAINAGE.
 3. SHALL ENSURE NO STANDING WATER AND ADEQUATE DRAINAGE.

EXPIRATION NOTICE
 THESE DOCUMENTS ARE ONLY VALID WITHIN ONE YEAR (365 DAYS) OF THE STAMP DATE. ONCE EXPIRED, THESE DOCUMENTS MUST BE REVIEWED BY NOREX ENGINEERING, INC. TO VERIFY EXISTING SITE CONDITIONS AND COMPLIANCE WITH APPLICABLE CODES.

COPYRIGHT:
 THIS DOCUMENT AND THE DESIGNS INCORPORATED HEREIN ARE NOT TO BE USED OR COPIED IN WHOLE OR IN PART FOR ANY OTHER PROJECTS OR PURPOSES WITHOUT THE EXPRESS WRITTEN AUTHORIZATION OF NOREX ENGINEERING, INC.

DISCLAIMERS:
 NOREX ENGINEERING DISCLAIMS ANY RESPONSIBILITY FOR THE ADEQUACY OF THE DESIGN DEPICTED IN THIS DRAWING UNTIL IT HAS SUCCESSFULLY COMPLETED ALL NECESSARY CONSTRUCTION INSPECTIONS AND RECEIVED THE ENGINEER'S CERTIFICATION.

IN MY PROFESSIONAL OPINION, THIS SYSTEM CAN BE OPERATED WITHOUT CAUSING A THREAT OR HARM TO ANY EXISTING OR PROPOSED WATER SUPPLY SYSTEM OR TO THE PUBLIC HEALTH, OR CAUSING THE THREAT OF POLLUTION OR NUISANCE CONDITIONS.

I, MICHAEL SCANLON, A REGISTERED PROFESSIONAL ENGINEER AUTHORIZED TO PRACTICE IN THE STATE OF TEXAS DO HEREBY CERTIFY THAT THE SEPTIC SYSTEM FOR THE EXISTING RUNGE BALL PARK RESTROOMS & CONCESSIONS SINK IF CONSTRUCTED OR PLACED IN ACCORDANCE WITH THESE DRAWINGS WILL COMPLY WITH ALL PROVISIONS OF THE REGULATIONS OF GALVESTON COUNTY, TEXAS FOR FLOOD PLAIN MANAGEMENT.

DESIGN BASIS 2 of 2 - SHEET S-2.2

Norex Engineering
 1220 East Main St., League City, Texas 77573
 CLIENT: GALVESTON COUNTY PARKS DEPARTMENT | PROJECT#: 07/01/2022 [REV #] 0
 CITY, STATE, ZIP: DALLAS, TX, 75241
 STREET: 10015 - 10015
 CHECK BY: [] | DATE: 05/09/2022 | DESIGNED BY: SHH | SCALE: | SEE DWG

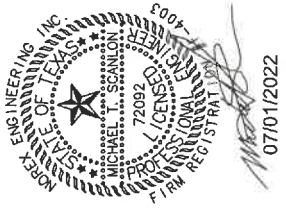

07/01/2022

EXISTING SEPTIC TANKS TO REMAIN DIAGRAM FOR REFERENCE ONLY INSTALLED TANKS MAY VARY

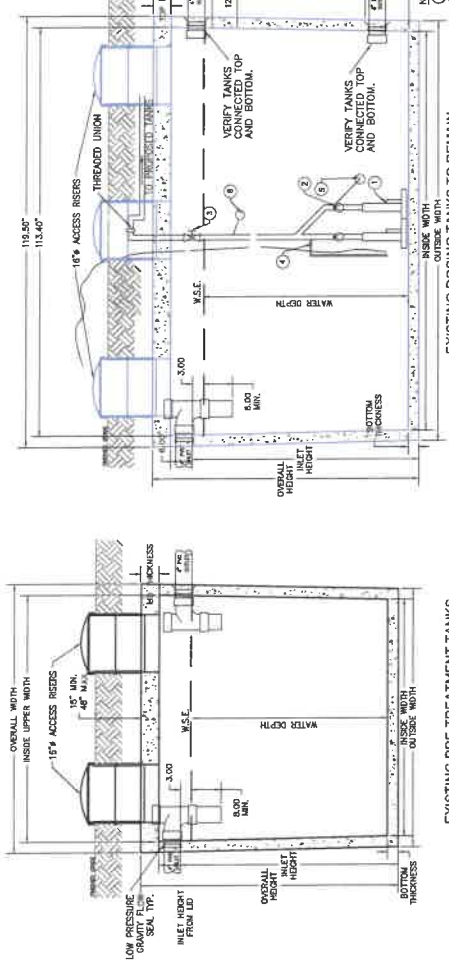

EXPIRATION NOTICE:
THESE DOCUMENTS ARE ONLY VALID WITHIN ONE YEAR (365 DAYS) OF THE STAMP DATE. ONCE EXPIRED, THESE DOCUMENTS MUST BE REVIEWED BY NOREX ENGINEERING, INC. TO VERIFY EXISTING SITE CONDITIONS AND COMPLIANCE WITH APPLICABLE CODES.

COPYRIGHT:
THIS DOCUMENT AND THE DESIGNS INCORPORATED HEREIN ARE NOT TO BE USED OR COPIED IN WHOLE OR IN PART FOR ANY OTHER PROJECTS OR PURPOSES WITHOUT THE EXPRESS WRITTEN AUTHORIZATION OF NOREX ENGINEERING, INC.

DISCLAIMER:
NOREX ENGINEERING DISCLAIMS ANY RESPONSIBILITY FOR THE ACCURACY OF THE DESIGN DEPICTED IN THIS DRAWING UNTIL SUCCESSFULLY COMPLETED ALL NECESSARY CONSTRUCTION INSPECTIONS AND RECEIVED THE ENGINEER'S CERTIFICATION.

NOTES:
ALL DISPOSAL SUPPLY LINES TO BE 1/2" PURPLE PVC SCH 40 OR SDR 26 AND ALL RETURN LINES TO BE 1" PURPLE PVC SCH 40 OR SDR 26. THIS IS A SITE SPECIFIC DESIGN TAKING INTO CONSIDERATION SOIL TYPE, GROUND WATER, AND TOPOGRAPHY AND IS SUITABLE FOR OPERATION IN THE ENVIRONMENT.

ON SITE SEWAGE PERMIT MUST BE OBTAINED FROM COUNTY PRIOR TO INSTALLATION OF SYSTEM. INSTALLATION OF SYSTEM MUST BE PERFORMED BY LICENSED INSTALLER. NO COMPONENT OF THIS SYSTEM IS TO BE COVERED UNTIL APPROVED BY COUNTY.

MAINTENANCE IS REQUIRED FOR THIS SYSTEM.

IT HAS ACTUAL LOCATION OF EFFLUENT LINES MAY BE ADJUSTED TO ACCOMMODATE TREES, SHRUBS, ETC. ANY MAJOR MODIFICATIONS MUST GET APPROVAL FROM THE ENGINEER AND COUNTY AND ALL MINIMUM SEPARATIONS MUST BE MAINTAINED. ANY DISCREPANCIES BETWEEN DESIGN AND ACTUAL FIELD CONDITIONS MUST BE REPORTED TO THE ENGINEER AND COUNTY PRIOR TO COMMENCING THE INSTALLATION. OWNER IS RESPONSIBLE FOR REMOVAL OF TREES.

ALL WATER WELLS LOCATED 50 FEET OR LESS FROM ANY PROPERTY LINES MUST BE PRESSURE CEMENT CASED TO A DEPTH OF NO LESS THAN 100 FEET. NO WELLS MAY BE PLACED CLOSER THAN 10 FEET FROM PROPERTY LINES.

DISPOSAL FIELD SHALL HAVE GRASSY COVER, AND OWNER IS RESPONSIBLE FOR MAINTAINING THIS VEGETATION. THIS AREA SHALL NOT BE UTILIZED FOR AGRICULTURAL PURPOSES.

SYSTEM COMPONENTS SHOULD BE 10 FEET FROM WATER LINES EXCEPT AT BUILDING CONNECTION OR CONSTRUCTED PER 30 TAC 290.44E. ALL NON-BURIED COMPONENTS SHALL BE CHAPTER ABOVE THE 100-YEAR FLOOD ELEVATION. SEE CHAPTER 285.7-ON-SITE SEWAGE FACILITIES OF THE TEXAS COMMISSION ON ENVIRONMENTAL QUALITY FOR REQUIREMENTS.

REFER TO "TCEQ" CHAPTER 285 SUB CHAPTER D, SEC. 285.34 OTHER REQUIREMENTS (3) PUMP SPECIFICATIONS: A SINGLE PUMP MAYBE USED FOR FLOWS EQUAL TO OR LESS THAN 1,000 GALLONS PER DAY. DUAL PUMPS ARE REQUIRED FOR FLOWS GREATER THAN 1,000 GALLONS PER DAY.

IF LOCATED IN THE 100 YEAR FLOOD PLAIN, THIS DESIGN TAKES INTO CONSIDERATION BUOYANCY CALCULATIONS TO REDUCE THE RISK OF AN EVACUATED PUMP TANK HEAVING FROM ITS INTENDED POSITION. HOWEVER, THE TANK IS NOT DESIGNED TO BE IN THE PATH OF RUSHING WATER. ANY DAMAGE OR CONTAMINATION DUE TO MOVING WATER IS NOT THE RESPONSIBILITY OF THE ENGINEER. ALL WATER HEATERS, FURNACES, AIR CONDITIONING UNITS, ELECTRICAL DISTRIBUTION PANELS AND ANY OTHER MECHANICAL OR ELECTRICAL EQUIPMENT MUST BE ELEVATED EIGHTEEN INCHES ABOVE THE BASE (100 YEAR) FLOOD ELEVATION. ANY ELECTRICAL CIRCUIT SERVING A LIGHT SWITCH OR OUTLET LOCATED BELOW THE BASE (100 YEAR) FLOOD ELEVATION SHALL BE DROPPED FROM ABOVE AND BE ON A SEPARATE BREAKER. ANY STORAGE AREAS BELOW THE BASE (100 YEAR) FLOOD ELEVATION ARE LESS THAN 150 SOFT IN SIZE. ALL MATERIALS USED BELOW THE BASE (100 YEAR) FLOOD ELEVATION ARE ON APPROVED FEMA TECHNICAL BULLETIN 2-93 AS CLASS 5 WATER RESISTANT.

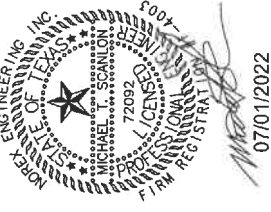

07/01/2022

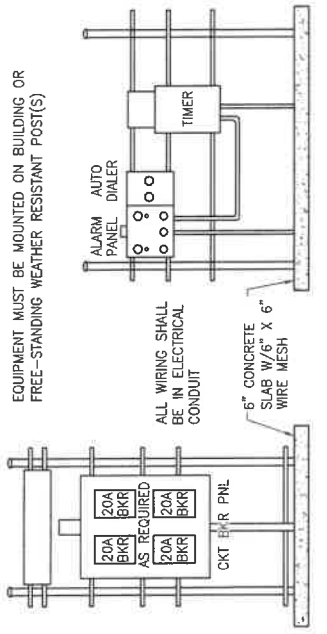

NOTE:
ALL ELECTRICAL OR MECHANICAL EQUIPMENT MUST BE ELEVATED TO AT LEAST 18" ABOVE FLOOD BASE ELEVATION PER REGULATIONS OF HARRIS COUNTY, TEXAS FOR FLOODPLAIN MANAGEMENT UNDER SECTION 4.05 (CONDITIONS OF CLASS II PERMIT)

SYSTEM CONTROL PANEL (TYPICAL)

HIGH LEVEL ALARM: ON SEPARATE CIRCUIT TO ACTIVATE WHEN LEVEL REACHES 3" ABOVE "ON" POSITION OF FLOAT SWITCH.

ALARM TO PRODUCE BOTH AUDIO & VISUAL ALERT PER TCEQ 285.32(b)(1)

FLOAT SWITCH: 13 AMP MIN., 50 AMP SURGE

OPERATING RANGE: 18 INCHES 285.33 (g)(2)(G)(iii)(i)

IN WATERSHEDS WHERE ONE OR MORE STREAM SEGMENTS ARE LISTED AS IMPAIRED FOR BACTERIA ON THE EPA 303(d) LIST, THE FOLLOWING ADDITIONAL REQUIREMENTS WILL APPLY REGARDING MAINTENANCE, DESIGNS AND INSTALLATION:

- ELECTRONIC MONITORING AS OUTLINED IN AMENDMENT M(4) SHALL BE REQUIRED FOR ALL NEW AND REPLACEMENT ON-SITE SEWAGE FACILITIES.
- AVERAGE CBOD OF 10 MG/L AND TSS OF 10 MG/L ON NSF STANDARD 40 UNITS THIS MUST BE DEMONSTRATED BY TEST RESULTS. ON ENGINEERED ONE OF A KIND SYSTEMS, A DESIGNER PARAMETER OF 5 MG/L CBOD & 5 MG/L TSS SHALL BE USED. PUMP TANKS SHALL BE EQUIPPED SUCH THAT WHEN PUMPING, A PORTION OF THE EFFLUENT IS RETURNED BELOW STATIC WATER LEVEL TO INSURE SCOUR OF THE PUMP TANK BOTTOM.
- ABANDONED TANKS, BORE HOLES, CESSPOOLS, AND SEEPAGE PITS.

A. AN ABANDONED TANK IS A TANK THAT IS NOT TO BE USED AGAIN FOR HOLDING SEWAGE.

B. TO PREVENT BOREHOLES, THE MINIMUM SHALL BE 18" ABOVE FLOOD PLAIN ELEVATION.

- TANKS, BOREHOLES, CESSPOOLS, SEEPAGE PITS, HOLDING TANKS, AND PUMP TANKS SHALL HAVE THE WASTEWATER REMOVED BY A WASTE TRANSPORTER, HOLDING TANKS, BOREHOLES, CESSPOOLS, SEEPAGE PITS, HOLDING TANKS, AND PUMP TANKS SHALL BE FILLED TO GROUND LEVEL WITH FILL MATERIAL (LESS THAN 3 INCHES IN DIAMETER) WHICH IS FREE OF ORGANIC AND CONSTRUCTION DEBRIS.

EXISTING TREATMENT TO REMAIN: 3-1,000 GALLON PRE-TREATMENT TANK 2-1,500 GALLON DOSING TANKS

NOREX ENGINEERING
1220 East Main St. League City, Texas 77573
TEL: (281) 474-2640 FAX: (281) 474-2748

CLIENT: GALVESTON COUNTY PWS DEPARTMENT | PROJECT: 07/01/2022 REV # 1 0
CITY/STATE: ZIP | COUNTY: TX | DATE: 07/01/2022
CHECK BY: JAS | DATE: 05/09/2022 | DESIGNED BY: SAR | SCALE: SEE RWS

NOTES:
 ALL DISPOSAL SUPPLY LINES TO BE 1/2" PURPLE PVC SCH 40 OR SDR 26 AND ALL RETURN LINES TO BE 4" PURPLE PVC SCH 40 OR SDR 26. THIS IS A SITE SPECIFIC DESIGN TAKING INTO CONSIDERATION SOIL TYPE, GROUND WATER, AND TOPOGRAPHY AND IS SUITABLE FOR OPERATION IN THE ENVIRONMENT.

ON SITE SEWAGE PERMIT MUST BE OBTAINED FROM COUNTY PRIOR TO INSTALLATION OF SYSTEM. INSTALLATION OF SYSTEM MUST BE PERFORMED BY LICENSED INSTALLER. NO COMPONENT OF THIS SYSTEM IS TO BE COVERED UNTIL APPROVED BY COUNTY.

MAINTENANCE IS REQUIRED FOR THIS SYSTEM.
 ACTUAL LOCATION OF EFFLUENT LINES MAY BE ADJUSTED TO ACCOMMODATE TREES, SHRUBS, ETC. ANY MAJOR MODIFICATIONS MUST GET APPROVAL FROM THE ENGINEER AND COUNTY AND ALL MINIMUM SEPARATIONS MUST BE MAINTAINED. ANY DISCREPANCIES BETWEEN DESIGN AND ACTUAL FIELD CONDITIONS MUST BE REPORTED TO THE ENGINEER AND COUNTY PRIOR TO COMMENCING THE INSTALLATION. OWNER IS RESPONSIBLE FOR REMOVAL OF TREES.

ALL WATER WELLS LOCATED 50 FEET OR LESS FROM ANY PROPERTY LINES MUST BE PRESSURE CEMENT CASED TO A DEPTH OF NO LESS THAN 100 FEET. NO WELLS MAY BE PLACED CLOSER THAN 10 FEET FROM PROPERTY LINES.

DISPOSAL FIELD SHALL HAVE GRASSY COVER, AND OWNER IS RESPONSIBLE FOR MAINTAINING THIS VEGETATION. THIS AREA SHALL NOT BE UTILIZED FOR AGRICULTURAL PURPOSES.

SYSTEM COMPONENTS SHOULD BE 10 FEET FROM WATER LINES EXCEPT AT BUILDING CONNECTION OR CONSTRUCTED PER 30 TAC 290.44E. ALL NON-BURIED COMPONENTS SHALL BE ELEVATED ABOVE THE 100-YEAR FLOOD ELEVATION. SEE CHAPTER 285.7-ON-SITE SEWAGE FACILITIES OF THE TEXAS COMMISSION ON ENVIRONMENTAL QUALITY FOR REQUIREMENTS.

REFER TO "TCEQ" CHAPTER 285 SUB CHAPTER D, SEC. 285.34 OTHER REQUIREMENTS (3) PUMP SPECIFICATIONS: A SINGLE PUMP MAYBE USED FOR FLOWS EQUAL TO OR LESS THAN 1,000 GALLONS PER DAY. DUAL PUMPS ARE REQUIRED FOR FLOWS GREATER THAN 1,000 GALLONS PER DAY.

IF LOCATED IN THE 100 YEAR FLOOD PLAIN, THIS DESIGN TAKES INTO CONSIDERATION BUOYANCY CALCULATIONS TO REDUCE THE RISK OF AN EVACUATED PUMP TANK HEAVING FROM ITS INTENDED POSITION. HOWEVER, THE TANK IS NOT DESIGNED TO BE IN THE PATH OF RUSHING WATER. ANY DAMAGE OR CONTAMINATION DUE TO MOVING WATER IS NOT THE RESPONSIBILITY OF THE ENGINEER. ALL WATER HEATERS, FURNACES, AIR CONDITIONING UNITS, ELECTRICAL DISTRIBUTION PANELS AND ANY OTHER MECHANICAL OR ELECTRICAL EQUIPMENT MUST BE ELEVATED EIGHTEEN INCHES ABOVE THE BASE (100 YEAR) FLOOD ELEVATION. ANY ELECTRICAL CIRCUIT SERVING A LIGHT SWITCH OR OUTLET LOCATED BELOW THE BASE (100 YEAR) FLOOD ELEVATION SHALL BE DROPPED FROM ABOVE AND BE ON A SEPARATE BREAKER. ANY STORAGE AREAS BELOW THE BASE (100 YEAR) FLOOD ELEVATION ARE LESS THAN 150 SOFT IN SIZE. ALL MATERIALS USED BELOW THE BASE (100 YEAR) FLOOD ELEVATION ARE ON APPROVED FEMA TECHNICAL BULLETIN 2-93 AS CLASS 5 WATER RESISTANT.

PROPOSED TREATMENT TO BE ADDED:
 1 - 1,500 GALLON NSF TESTED TREATMENT TANK
 1 - 2,200 GALLON PUMP TANK

PROPOSED TANK DIAGRAMS - SHEET S-3.1

CLIENT	DAWSON COUNTY PARKS DEPARTMENT	REVISION DATE	07/01/2022
CITY	DAWSON COUNTY, TEXAS	PROJECT NO.	2022-001
DATE	05/09/2022	DRAWN BY	SAI
CHECKED BY	MS	SCALE	1/8" = 1'-0"

110.110.164General_CleanWater665 Peak Sheet Rev 06/2022.Dwg July 01, 2022 04:39pm

EXPIRATION NOTICE:
 THESE DOCUMENTS ARE ONLY VALID WITHIN ONE YEAR (365 DAYS) OF THE STAMP DATE. ONCE EXPIRED, THESE DOCUMENTS MUST BE REVIEWED BY NOREX ENGINEERING, INC. TO VERIFY EXISTING SITE CONDITIONS AND COMPLIANCE WITH APPLICABLE CODES.

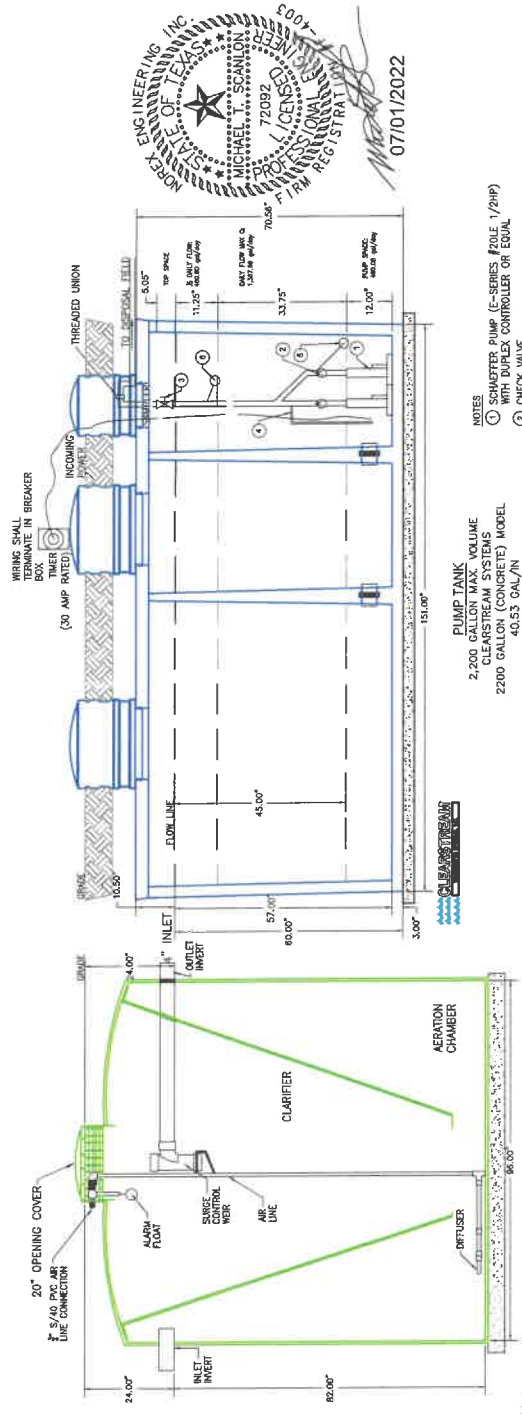

- NOTES:**
1. SCHAEFER PUMP (E-SERIES #20LE 1/2HP) WITH DUPLEX CONTROLLER OR EQUAL
 2. CHECK VALVE
 3. GATE VALVE
 4. BYPASS PIPE
 5. FLOAT SWITCH
 6. HIGH LEVEL ALARM FLOAT

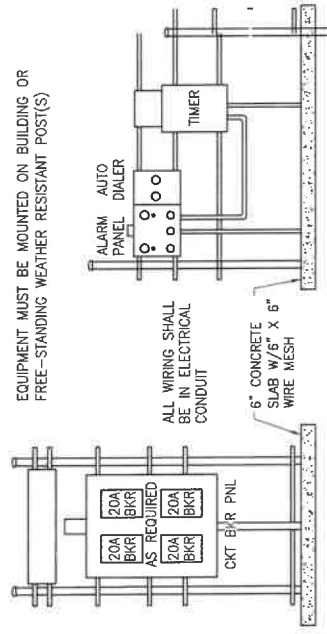

NOTE:
 ALL ELECTRICAL OR MECHANICAL EQUIPMENT MUST BE ELEVATED TO AT LEAST 18" ABOVE FLOOD BASE ELEVATION PER "REGULATIONS OF HARRIS COUNTY, TEXAS FOR FLOODPLAIN MANAGEMENT" UNDER SECTION 4.05 (CONDITIONS OF CLASS II PERMIT)

HIGH LEVEL ALARM: ON SEPARATE CIRCUIT TO ACTIVATE WHEN LEVEL REACHES 3" ABOVE "ON" POSITION OF FLOAT SWITCH.
**ALARM TO PRODUCE BOTH AUDIO & VISUAL ALERT PER TCEQ 285.32(b)(1)
 FLOAT SWITCH: 1/3 AMP MIN., 50 AMP SURGE
 OPERATING RANGE: 18 INCHES 285.33 (d)(2)(G)(iii)(i)**

IN WATERSHEDS WHERE ONE OR MORE STREAM SEGMENTS ARE LISTED AS IMPAIRED FOR BACTERIA ON THE EPA 303(D) LIST, THE FOLLOWING ADDITIONAL REQUIREMENTS WILL APPLY REGARDING MAINTENANCE, DESIGN AND INSTALLATION:

1. ELECTRONIC MONITORING AS OUTLINED IN AMENDMENT M(4) SHALL BE REQUIRED FOR ALL NEW AND REPLACEMENT ON-SITE SEWAGE FACILITIES.
2. ALL ON-SITE SEWAGE FACILITIES MUST USE SECONDARY TREATMENT MEETING A 20 DAY AVERAGE CBOD OF 10 MG/L AND TSS OF 10 MG/L ON NSF STANDARD 40 UNITS THIS MUST BE DEMONSTRATED BY TEST RESULTS. ON ENGINEERED ONE OF A KIND SYSTEMS, A DESIGNER PARAMETER OF 5 MG/L CBOD & 5 MG/L TSS SHALL BE USED. PUMP TANKS SHALL BE EQUIPPED SUCH THAT WHEN PUMPING, A PORTION OF THE EFFLUENT IS RETURNED BELOW STATIC WATER LEVEL TO INSURE SCOUR OF THE PUMP TANK BOTTOM.

ABANDONED TANKS BORE HOLES, CESSPOOLS, AND SEEPAGE PITS.

- A. AN ABANDONED TANK IS A TANK THAT IS NOT TO BE USED AGAIN FOR HOLDING SEWAGE. TO PROPERLY ABANDON, THE OWNER SHALL CONDUCT THE FOLLOWING ACTIONS:
 1. ALL TANKS, BOREHOLES, CESSPOOLS, SEEPAGE PITS, HOLDING TANKS, AND PUMP TANKS SHALL HAVE THE WASTEWATER REMOVED BY A WASTE TRANSPORTER, HOLDING A CURRENT REGISTRATION WITH THE EXECUTIVE DIRECTOR.
 2. ALL TANKS, BOREHOLES, CESSPOOLS, SEEPAGE PITS, HOLDING TANKS, AND PUMP TANKS SHALL BE FILLED TO GROUND LEVEL WITH FILL MATERIAL (LESS THAN 3 INCHES IN DIAMETER) WHICH IS FREE OF ORGANIC AND CONSTRUCTION DEBRIS.

DISCLAIMER:
 NOREX ENGINEERING DISCLAIMS ANY RESPONSIBILITY FOR THE ADEQUACY OF THE DESIGN DEPICTED IN THIS DRAWING UNTIL IT HAS SUCCESSFULLY COMPLETED ALL NECESSARY CONSTRUCTION INSPECTIONS AND RECEIVED THE ENGINEER'S CERTIFICATION.

COPYRIGHT:
 THIS DOCUMENT AND THE DESIGNS INCORPORATED HEREIN ARE NOT TO BE USED OR COPIED IN WHOLE OR IN PART FOR ANY OTHER PROJECTS OR PURPOSES WITHOUT THE EXPRESS WRITTEN AUTHORIZATION OF NOREX ENGINEERING, INC.



07/01/2022



E SERIES ENVIRONMENTAL PUMPS - 20 GPM THERMOPLASTIC

PERFORMANCE

4605 Peck Avenue
Santa Fe, Texas 77510

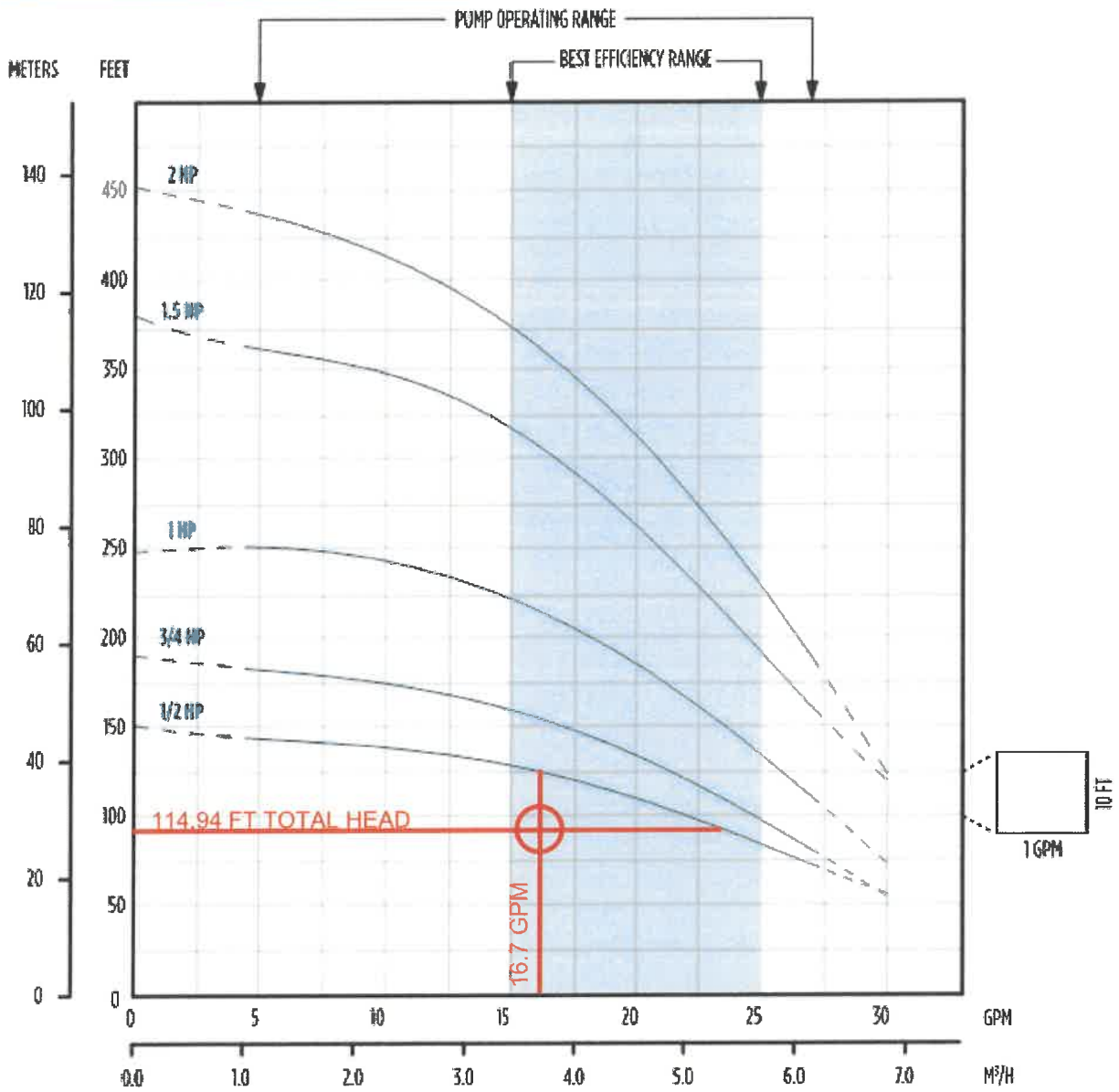

USING 1-1/4 INCH PVC DISPOSAL HEADER LINE

4605 Peck Avenue
Santa Fe, Texas 77510



Pump Specifications

LE40 Series

4/10 HP Submersible Sewage Pump

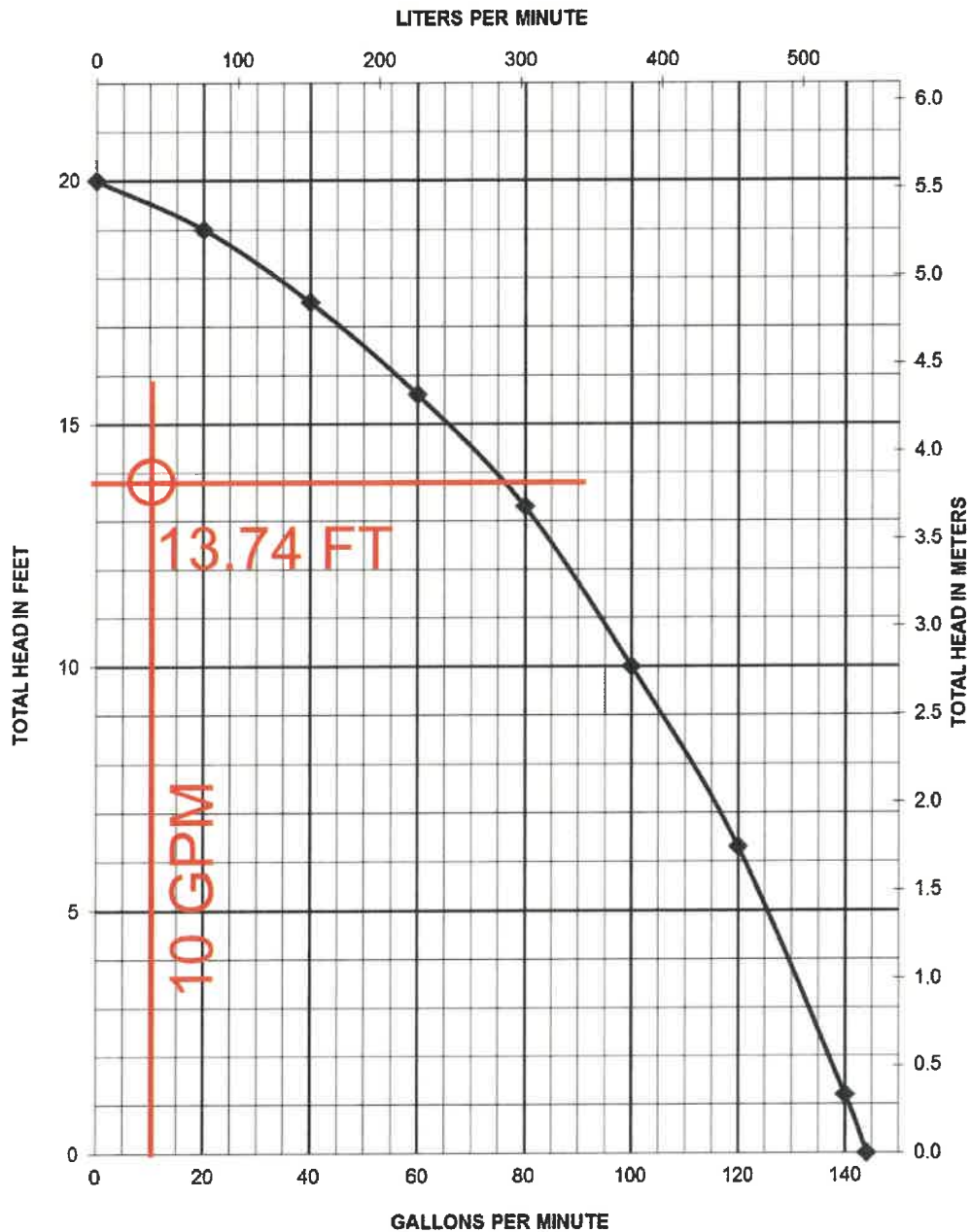
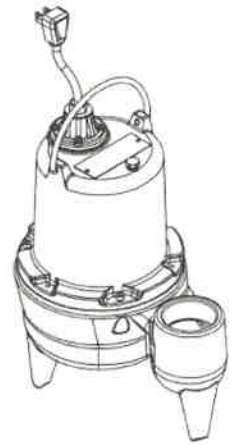

National Flood Hazard Layer FIRMette

95°7'38"W 29°22'53"N 4605 Peck Avenue, Santa Fe, Texas 77510



Legend

SEE FIS REPORT FOR DETAILED LEGEND AND INDEX MAP FOR FIRM PANEL LAYOUT

SPECIAL FLOOD HAZARD AREAS

- Without Base Flood Elevation (BFE) Zone A, V, AG9
- With BFE or Depth Zone AE, AO, AH, VE, AR
- Regulatory Floodway

OTHER AREAS OF FLOOD HAZARD

- 0.2% Annual Chance Flood Hazard, Areas of 1% annual chance flood with average depth less than one foot or with drainage areas of less than one square mile Zone X
- Future Conditions 1% Annual Chance Flood Hazard Zone X
- Area with Reduced Flood Risk due to Levee. See Notes. Zone X
- Area with Flood Risk due to Levee Zone D

OTHER AREAS

- NO SCREEN Area of Minimal Flood Hazard Zone X
- Effective LOMRS
- Area of Undetermined Flood Hazard Zone D

GENERAL STRUCTURES

- Channel, Culvert, or Storm Sewer
- Levee, Dike, or Floodwall

CROSS SECTIONS WITH 1% ANNUAL CHANCE WATER SURFACE ELEVATION

- 20.2
- 17.5
- 8
- Coastal Transect
- Base Flood Elevation Line (BFE)
- Limit of Study

OTHER FEATURES

- Jurisdiction Boundary
- Coastal Transect Baseline
- Profile Baseline
- Hydrographic Feature

MAP PANELS

- Digital Data Available
- No Digital Data Available
- Unmapped

The pin displayed on the map is an approximate point selected by the user and does not represent an authoritative property location.

This map complies with FEMA's standards for the use of digital flood maps if it is not void as described below. The basemap shown complies with FEMA's basemap accuracy standards.

The flood hazard information is derived directly from the authoritative NFHL web services provided by FEMA. This map was exported on 6/22/2022 at 11:31 AM and does not reflect changes or amendments subsequent to this date and time. The NFHL and effective information may change or become superseded by new data over time.

This map image is void if the one or more of the following map elements do not appear: basemap imagery, flood zone labels, legend, scale bar, map creation date, community identifiers, FIRM panel number, and FIRM effective date. Map images for unmapped and unmodernized areas cannot be used for regulatory purposes.



95°7'1"W 29°22'22"N

Feet 1:6,000

0 250 500 1,000 1,500 2,000

Basemap: USGS National Map: OrthoImagery: Data refreshed October, 2020

Galveston County Health District Site Evaluation Form

Date: 06/22/2022

Client: Jimmy Gibson, GCPD

Address: 2222 28th Street

Phone: (409) 443-4292

City, State Zip: Galveston, Texas 77550

Legal Description:

Site Address: 4605 Peck Avenue

City/Area: Santa Fe, Texas 77510

Subdivision: Unknown Subdivision

Sec: XX Lot: XX Block: XX

Survey: Unknown Survey

Abstract No: XX

Property Size: XXX Sq. Ft.

Acres: XX Ac.

Existing or proposed structure to be served: (Circle one) Existing Structure/New Structure

Topography

Slope	Vegetation	Drainage
Flat: Under 2% <u>XX</u> Note: If slope is flat a detailed drainage plan shall be provided on design.	Grass/Brush: <u>XX</u>	Poor: _____ Note: If drainage is poor a detailed drainage plan shall be provided on design.
Slight: Under 4% _____	Lightly Wooded: _____	Adequate: <u>XX</u>
Severe: Over 30% _____ Note: If slope is severe a Topo Survey with half foot contours should be provided with this form on design.	Heavily Wooded: _____	Good: _____
Other:	Other:	Other:

Flood Hazard

Property is located:

Outside 100 year flood plain: XX

*In 100 year flood plain: _____

In 100 year flood plain and floodway: _____

Note: *Systems installed in flood plain must document how floatation concerns will be addressed on design. Attach a FEMA Flood Insurance Rate Map (FIRM) with property location identification or current survey with Flood Plain determination.

Soil Evaluation

(Based on at least two soil borings or two backhoe pits at opposite ends of the soil absorption area)

Mocarey Rarely Flooded-Lenton Occasionally Flooded Complex



B-1

Profile Depth	Texture (USDA)	Color
00" - 12"	Loam	Light Brown
12" - 31"	Sandy Clay Loam	Light Brown
31" - 50"	Sandy Clay Loam	Light Brown
50" - 60"	Sandy Clay Loam	Light Brown

(Minimum depth is two feet below proposed excavation)



B-2

Profile Depth	Texture (USDA)	Color
00" - 12"	Loam	Light Brown
12" - 31"	Sandy Clay Loam	Light Brown
31" - 50"	Sandy Clay Loam	Light Brown
50" - 60"	Sandy Clay Loam	Light Brown

SAME AS ABOVE

(Minimum depth is two feet below proposed excavation)

Normal Textures (USDA) course sand/gravel, loamy sand, sandy loam, loam, sandy clay, clay loam, silty clay, clay.
Note: Location of bore holes must be shown on design or on a separate sheet of paper.

(In space below show location of borings/backhoe pit(s))

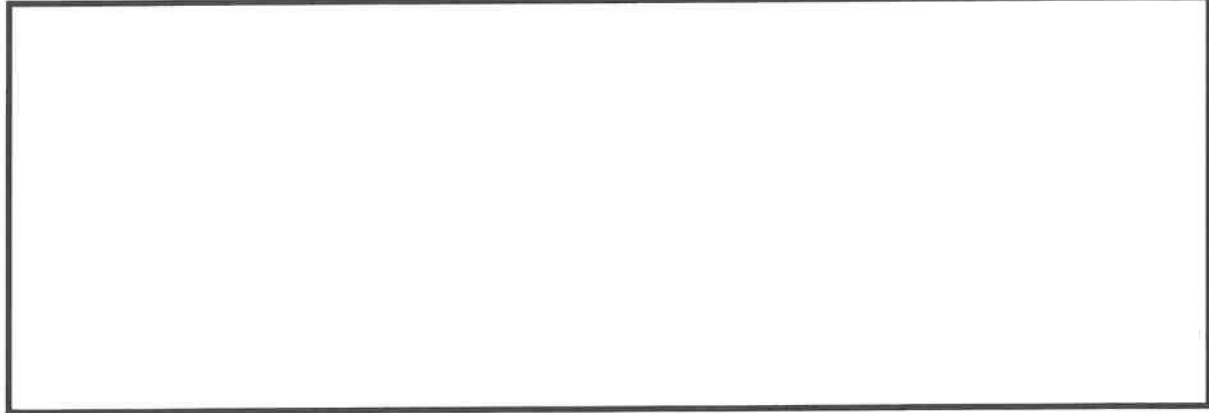

RESTRICTIVE HORIZON

Restrictive Horizon within 24" below bottom of proposed excavation? Yes _____ No >80"

GRAVEL ANALYSIS

(For Class II and Class III Soils with Gravel)

% Total Gravel: _____

% Gravel Less Than 2.0 mm: _____

% Gravel Greater than 5.0 mm: _____

EFFLUENT LOADING DETERMINATION

<u>Soil Class/Texture</u>	<u>Gallons per day per square foot</u>
Ia/Gravelly Soil >30% Gravel	To great for consideration >0.5
Ib/Sandy solis with <30% gravel	0.38
II/Sandy loams/loams	0.25
III/Sandy clay/clay loams	<u>0.20</u>
IV/Clay/silty clays	Unsuitable 0.10

Indication of seasonal water table: (Circle One) Yes No
Depth: 0"-36"

FINDINGS

Is soil suitable for standard subsurface disposal methods? (Circle One) Yes No

Wastewater application rate 0.2 Gal/day/sq.ft.

I, Michael T. Scanlon, a registered Professional Engineer

did personally conduct the site evaluation on 05/11/2022
(Date)

I certify that these results are true and correct for the property evaluated.

Site Evaluator

TX PE #72092
Registration Number

ATTACHMENT A REQUIRED DOCUMENTS

Respondents shall submit One (1) single-sided unbound original, and four (4) single-sided copies of the required documents listed in this section.

No other documentation (solicitation instructions, maps, drawings addenda, etc.) is required unless superseded by instructions in the Special Provisions.

The sealed Required Documents must be submitted no later than 2:00 P.M. CST, on Friday, February 24, 2023, to the following:

**Rufus G. Crowder, CPPO CPPB
Purchasing Agent
County of Galveston
722 Moody Avenue (21st Street), Fifth (5th) Floor
Galveston, TX 77550**

The timestamp clock located in the Purchasing Agent’s office shall serve as the official time-keeping piece for this solicitation process. Any proposals received after 2:00 P.M. CST on the specified date will be returned unopened.

Table of Contents

- A. VENDOR QUALIFICATION PACKET 2
- B. CERTIFICATE REGARDING LOBBYING..... 2
- C. NON-COLLUSION AFFIDAVIT 2
- D. PROHIBITION ON CONTRACTS WITH COMPANIES BOYCOTTING ISRAEL .. 2
- E. PROHIBITION ON CONTRACTS WITH CERTAIN COMPANIES 2
- F. GALVESTON COUNTY BID SPECIFICATIONS..... 2
- G. BID SHEET 2
- H. LINE ITEMS..... 2

BID #: B231010
OPEN: 02/24/2023
2:00 PM

BID SHEET

SEPTIC TANK SERVICES-RUNGE PARK

GALVESTON COUNTY, TEXAS

Having read and understood the instructions, terms, conditions, specifications, and invitation to bid we submit the following:

LINE ITEM \$ _____

OPTIONS TO RENEW: No Extensions/Non-Applicable

WITNESS

COMPANY NAME

DATE

AUTHORIZED REPRESENTATIVE'S SIGNATURE

PRINTED NAME

TITLE

CORRESPONDENCE ADDRESS

REMIT ADDRESS

CITY, STATE ZIP CODE

CITY, STATE ZIP CODE

TAX IDENTIFICATION NUMBER (TIN/FIEN/SSN)

TELEPHONE NUMBER

FAX NUMBER

ADDENDUM'S RECEIVED #1 _____ #2 _____ #3 _____

LINE ITEM DETAIL

BID #: B231010
OPEN: 02/24/2023
2:00 PM

SEPTIC TANK SERVICES-RUNGE PARK

GALVESTON COUNTY, TEXAS

VENDOR

Item No.	Product Code	Description	Quantity	Units	Catalog #	Unit Price	Extended Price
0001	96100	SEPTIC TANK SERVICES-RUNGE PARK		EA		\$	\$
Extended Price Total of all Items: \$							



CONTRACTOR'S CERTIFICATION of RECOVERED MATERIALS

ACKNOWLEDGEMENT

I, _____ (Principal's Name) of _____ (Company Name), (hereinafter called "Contractor"), acknowledge the recovered material bidding requirements found in 2 CFR 200.322 that require the Contractor to procure those items designated in the guidelines of the Environmental Protection Agency (EPA) at 40 CFR 247 that contain the highest percentage of recovered materials practicable, consistent with maintaining a satisfactory level of competition.

I also acknowledge that this requirement shall apply to items purchased (1) where the Contractor purchases in excess of \$10,000 of the item under this contract; or (2) where during the preceding fiscal year, the value of the quantity acquired was in excess of \$10,000.

Finally, I acknowledge referencing the list of recovered materials mentioned in the bid documents. For up-to-date listing, please go to <https://www.epa.gov/smm/comprehensive-procurement-guideline-cpg-program#directory>

Printed Name and Title

Signature

Date

USE OF RECOVERED MATERIALS

Please check one:

- Recovered materials are included in this bid:
Materials included _____
- Recovered materials are not reasonably available in a reasonable period of time.
- Recovered materials fail to meet reasonable performance standards, which are determined based on the guidelines of the National Institute of Standards and Technology, if applicable.
- Recovered materials are only available at an unreasonable price.

Printed Name and Title

Signature

Date



Prohibition on Contracts with Companies Boycotting Israel

Prohibition on contracts with companies boycotting Israel per Government Code 2271.001 Definitions:

- (1) "Boycott Israel" has the meaning assigned by Section 808.001.
- (2) "Company" has the meaning assigned by Section 808.001; except that the term does not include a sole proprietorship.
- (2) "Governmental entity" has the meaning assigned by Government Code, Section 2251.001.

PROVISION REQUIRED IN CONTRACT. (a) This section applies only to a contract that:

- (1) is between a governmental entity and a company with 10 or more full-time employees; and
- (2) has a value of \$100,000 or more that is to be paid wholly or partly from public funds of the governmental entity.

(b) A governmental entity may not enter into a contract with a company for goods or services unless the contract contains a written verification from the company that it:

- (1) does not boycott Israel; and
- (2) will not boycott Israel during the term of the contract.

As required by GOVERNMENT CODE, CHAPTER 2271, CONTRACTOR hereby verifies that it does not boycott Israel and will not boycott Israel throughout the term of this Agreement. For the purposes of this verification, "Boycott Israel" means refusing to deal with, terminating business activities, or otherwise taking any action that is intended to penalize, inflict economic harm on, or limit commercial relations specifically with Israel, or a person or entity doing business in Israel or in an Israeli-controlled territory, but does not include an action made for ordinary business purposes.

Individual by oath swears that the following statements are factual and true:

1. Individual is authorized by the Contractor to make this statement for the Contractor.
2. Individual has read and is fully aware of the facts stated in this statement.
3. Individual can read and comprehend the English language.
4. In accordance with Texas Government Code Section 2271.002, this company does not boycott Israel and will not boycott Israel during the term of this contract/agreement.

Date: _____

Business Name of Contractor: _____

Company Address: _____

County of Contractor: _____

A Individual: _____

Signature of Individual: _____

CERTIFICATION REGARDING LOBBYING
(31 U.S.C.A. § 1352)
This Certification must be completed, signed, dated and
returned to the Galveston County Purchasing Agent

Procurement Number and Description:

RFP #B231010 Septic Tank Services—Runge Park

Proposer **CERTIFIES**, to the best of its knowledge and belief, that:

1. No Federal appropriated funds have been paid or will be paid, by or on behalf of the proposer, to any person for influencing or attempting to influence an officer or employee of an agency, a Member of Congress, an officer or employee of Congress, or an employee of a Member of Congress in connection with the awarding of any Federal contract, the making of any Federal grant, the making of any Federal loan, the entering into of any cooperative agreement, and the extension, continuation, renewal, amendment, or modification of any Federal contract, grant, loan, or cooperative agreement.
2. If any funds other than Federal appropriated funds have been paid or will be paid to any person for influencing or attempting to influence an officer or employee of any agency, a Member of Congress, an officer or employee of Congress, or an employee of a Member of Congress in connection with this Federal contract, grant, loan, or cooperative agreement, the proposer shall complete and submit **Standard Form LLL**, "Disclosure Form to Report Lobbying", in accordance with its instructions.
3. Proposer shall require that the language of this certification be included in the award documents for all subawards at all tiers (including subcontracts, subgrants, and contracts under grants, loans, and cooperative agreements) and that all subrecipients shall certify and disclose accordingly.

This certification is a material representation of fact upon which reliance was placed when this transaction was made or entered into. Submission of this certification is a prerequisite for making or entering into this transaction imposed by Section 1352, Title 31, U.S. Code. Any person who fails to file the required certification shall be subject to a civil penalty of not less than \$10,000 and not more than \$100,000 for each such failure.

Name of Organization/Corporation: _____

Address: _____

City: _____ State: _____ Zip Code: _____

Signature of Authorized Signatory for Proposer: _____ Date Signed: _____

Title of Authorized Signatory of Proposer: _____

State of Texas

§

County of Galveston

§

§

NON-COLLUSION AFFIDAVIT

Before me, the undersigned notary, on this day personally appeared _____ (Affiant), whom being first duly sworn, deposes and certifies that:

- Affiant is the _____ of _____, that
(Individual, Partner, Corporate Officer) (Name of Proposer)
- submitted the attached Bid/Proposal in **RFP #B231010 Septic Tank Services—Runge Park**
- Affiant is a duly authorized representative of Proposer and is authorized to make this Non-Collusion Affidavit;
- The attached Proposal/Bid is genuine and is not a collusive or sham Proposal/Bid;
- The attached Proposal/Bid has been independently arrived at without collusion with any other bidder, proposer, person, firm, competitor, or potential competitor;
- Bidder/Proposer has not colluded, conspired, connived or agreed, directly or indirectly, with any other bidder, proposer, person, firm, competitor, or potential competitor, to submit a collusive or sham bid or that such other bidder, proposer, person, firm, competitor, or potential competitor shall refrain from bidding/proposing;
- Bidder/Proposer has not in any manner, directly or indirectly, sought by agreement or collusion or communication or conference with any other bidder, proposer, person, firm, competitor, or potential competitor to fix the price or prices in the attached Bid/Proposal or of the bid/proposal any other bidder/proposer;
- Bidder/Proposer has not in any manner, directly or indirectly, sought by agreement or collusion or communication or conference with any other bidder, proposer, person, firm, competitor, or potential competitor to fix the overhead, profit or cost element of the Bid/Proposal price or prices of any other bidder/proposer, or to secure through any collusion, conspiracy, connivance, or unlawful agreement any advantage against Galveston County or any person interested in the proposed contract;
- Affiant has not in any manner, directly or indirectly, sought by agreement or collusion or communication or conference with any other bidder, proposer, person, firm, competitor, or potential competitor, paid or agreed to pay any other bidder, proposer, person, firm, competitor, or potential competitor any money or anything of value in return for assistance in procuring or attempting to procure a contract or in return for establishing the price or prices in the attached Bid/Proposal or the bid/proposal of any other Bidder/Proposer; and
- Affiant certifies that Affiant is fully informed regarding the accuracy of the statements contained herein, and under penalties of perjury, certifies and affirms the truth of the statements herein, such penalties being applicable to the Bidder/Proposer as well as to Affiant signing on its behalf.

Signature of Affiant

SWORN TO and SUBSCRIBED before me this _____ day of _____, _____.

Notary Public

My Commission Expires: _____



Prohibition on Contracts with Certain Companies

Prohibition on contracts with certain companies per Government Code 2252.151 Definitions:

- (1) "Company" has the meaning assigned by Section 806.001.
- (2) "Foreign terrorist organization" means an organization designated as a foreign terrorist organization by the United States secretary of state as authorized by 8 U.S.C. Section 1189.
- (3) "Governmental contract" means a contract awarded by a governmental entity for general construction, an improvement, a service, or a public works project for a purchase of supplies, materials, or equipment. The term includes a contract to obtain a professional or consulting service subject to Government Code, Chapter 2254.
- (4) "Governmental entity" has the meaning assigned by Government Code, Section 2252.001.

Section 2252.152 – CONTRACTS WITH COMPANIES ENGAGED IN BUSINESS WITH IRAN, SUDAN, OR FOREIGN TERRORIST ORGANIZATION PROHIBITED. A governmental entity may not enter into a governmental contract with a company that is identified on a list prepared and maintained under Section 806.051, 807.051, or 2252.153.

Section 2252.153 – Listed Companies. The comptroller shall prepare and maintain, and make available to each governmental entity, a list of companies known to have contracts with or provide supplies or services to a foreign terrorist organization.

Pursuant to Chapter 2252, Texas Government Code, **VENDOR** represents and certifies that, at the time of execution of this Agreement, neither Vendor, nor any wholly owned subsidiary, majority-owned subsidiary, parent company or affiliate of the same (i) engages in business with Iran, Sudan, or any foreign terrorist organization as described in Chapters 806 or 807 of the Texas Government Code, or Subchapter F of Chapter 2252 of the Texas Government Code, or (ii) is a company listed by the Texas Comptroller of Public Accounts under Sections 806.051, 807.051, or 2252.153 of the Texas Government Code. The term "foreign terrorist organization" in this paragraph has the meaning assigned to such term in Section 2252.151 of the Texas Government Code.

Individual by oath swears that the following statements are factual and true:

1. Individual is authorized by the Contractor to make this statement for the Contractor.
2. Individual has read and is fully aware of the facts stated in this statement.
3. Individual can read and comprehend the English language.
4. As required by GOVERNMENT CODE, CHAPTER 2252.152, CONTRACTOR hereby verifies that it is not identified on a list prepared and maintained under Section 806.051, 807.051, or 2252.153, or contracting with a company doing business with Iran, Sudan, or any foreign terrorist organizations.

Date: _____

Business Name of Contractor: _____

Company Address: _____

County of Contractor: _____

Name of Individual: _____

Signature of Individual: _____

**PROPOSAL FORMS
SEPTIC TANK SERVICES – RUNGE PARK
COUNTY OF GALVESTON, TEXAS**

By signing here, the firm does hereby attest that it has fully read the instructions, conditions and general and special provisions and understands them.

THE COMPANY OF: _____

ADDRESS: _____

FEIN (TAX ID): _____

The following shall be returned with your proposal. Failure to do so may be ample cause for rejection of the proposal as non-responsive. It is the responsibility of the Proposer to ensure that proposer has received all addenda.

Items:	Confirmed (X):
1. References (if required)	_____
2. Addenda, if any	#1_____ #2_____ #3_____ #4_____
3. One (1) original and four (4) copies of submittal	_____
4. Proposal Form	_____
5. Vendor Qualification Packet	_____
6. Line Item Details	_____
7. Non-Collusion Affidavit	_____
8. Payment Terms:	_____ net 30 _____ other
9. Contracts with Certain Companies	_____
10. Companies Boycotting Israel	_____
11. Bid Sheet	_____
12. Certification of Recovered Materials Form	_____

Person to contact regarding this bid: _____

Title: _____ Phone: _____ Fax: _____

E-mail address: _____

Name of person authorized to bind the Firm: _____

Signature: _____ Date: _____

Title: _____ Phone: _____ Fax: _____

E-mail address: _____

PROPOSAL FORMS
SEPTIC TANK SERVICES – RUNGE PARK
GALVESTON COUNTY, TEXAS

Proposer shall use this form to provide the information for notice.

1. Contact information for notice:

Name: _____
Address: _____

Telephone Number: _____ Facsimile number: _____

2. If a copy of notice is requested, please complete below:

Name: _____
Address: _____

Telephone Number: _____ Facsimile number: _____

3. If second or more copies are requested for notice, please supplement this form and clearly mark the supplement as "Supplementary Notice Information."

Proposer to submit reference information. Proposer shall use this form to provide minimum required reference information. If Proposer wishes to provide more than the minimum, Proposer should supplement this form and should clearly mark the supplement as "Supplementary Reference Information."

1. References who can attest to the Proposer's capability to carry out the requirements set forth in this bid:

Business Name of Organization: _____
Name of Person: _____
Title of Individual within Organization, if applicable _____
Business address: _____

Telephone number: _____ Facsimile number: _____

Business Name of Organization: _____
Name of Person: _____
Title of Individual within Organization, if applicable _____
Business address: _____

Telephone number: _____ Facsimile number: _____

Business Name of Organization: _____
Name of Person: _____
Title of Individual within Organization, if applicable _____
Business address: _____

Telephone number: _____ Facsimile number: _____

PROPOSAL FORMS
SEPTIC TANK SERVICES – RUNGE PARK
GALVESTON COUNTY, TEXAS

References of major supplier of Proposer who can speak to the financial capability of the Proposer to carry out the requirements set forth in this bid:

1. Business Name of Supplier _____
Name of Person: _____
Title of Individual within business: _____
Business address: _____

Telephone number: _____ Facsimile number: _____

2. Business Name of Supplier _____
Name of Person: _____
Title of Individual within business: _____
Business address: _____

Telephone number: _____ Facsimile number: _____

3. Business Name of Supplier _____
Name of Person: _____
Title of Individual within business: _____
Business address: _____

Telephone number: _____ Facsimile number: _____

The remainder of this page intentionally left blank

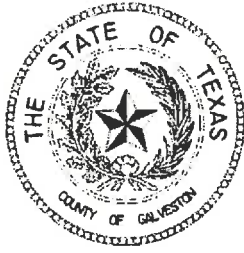

County of Galveston Purchasing Department Vendor Qualification Packet

(rev. 1.4, September 28, 2017)

All interested parties seeking consideration for qualified vendor status with the County of Galveston should complete and return only the following forms to:

Galveston County Purchasing Department
722 Moody Avenue, (21st Street), 5th Floor
Galveston, Texas 77550
(409) 770-5371 office
(409) 621-7987 fax

PEID Form: Person /Entity Information Data

W -9 Form: Request for Taxpayer Identification Number and Certification
(please note that the included form may not be the latest revised form issued by the Internal Revenue Service. Please check the IRS website at <http://www.irs.gov/pub/irs-rd/ffw9.pdf> for the latest revision of this form.)

CIQ Form: Conflict of Interest Questionnaire
(please note that the included form may not be the latest revised form issued by the State of Texas Ethics Commission. Please check the Texas Ethics Commission website at http://www.ethics.state.tx.us/whatsnew/conflict_forms.htm for the latest revision of this form. Please note that Galveston County Purchasing Agent is not responsible for the filing of this form with the Galveston County Clerk per instructions of the State of Texas Ethics Commission).

Debarment: **CERTIFICATION REGARDING DEBARMENT, SUSPENSION, PROPOSED DEBARMENT, AND OTHER RESPONSIBILITY MATTERS & REQUIREMENT TO REGISTER IN SAM**
*Vendors/contractor certifies that neither it, nor any of its Principals, are presently debarred, suspended, proposed for debarment, disqualified, excluded, or in any way declared ineligible for the award of contracts by any Federal agency. Vendor agrees that it shall refund Galveston County for any payments made to Contractor while ineligible. Vendor acknowledges that Contractor's uncured failure to perform under any agreement with the County of Galveston, if such should occur, may result in Contractor being debarred from performing additional work for the County, the respecting State Agency administering the grant funding the contract, if applicable, the State, FEMA or HUD (as applicable), and other Federal and State entities. Further, Vendor has executed the Certification Regarding Debarment, Suspension, Proposed Debarment, and Other Responsibility Matters and returned the fully completed and executed original certification with the submission of this Vendor Qualification Packet. **The truthful and fully completed and executed original of the Certification Regarding Debarment, Suspension, Proposed Debarment, and Other Responsibility Matters must be included with the submission of this Vendor Qualification Packet and is a mandatory requirement to become a vendor of Galveston County. Vendor's failure to include the fully completed and executed original of this Certification shall be considered non-compliant with the requirements of this vendor qualification request and grounds for the rejection of vendor's request. Vendor shall immediately notify the County Purchasing Agent if it becomes debarred or suspended, placed on***

the Consolidated List of Debarred Contractors, or in any other way becomes ineligible for award of contract by any Federal agency. This Certification is a material fact relied upon by Galveston County; if it is later determined that the vendor did not comply with 2 C. F. R. Part 180 and 2 C.F.R. Part 3000, in addition to the remedies available to Galveston County and the State agency administering a grant, the Federal Government may pursue available remedies, including but not limited to suspension and/or debarment of contractor. If the contract to be awarded pursuant to a Galveston County procurement effort involves the use of Federal funds, then vendor must also be registered in the Federal Contractor Registry through the System for Award Management (SAM) to be eligible for award of contract pursuant to the procurement.

Information regarding the SAM is available at:

<http://federalcontractorregistry.com/?gclid=CIGlhf2rr8wCFYkCaQoducANZw> or at <http://sam.gov/portal/SAM/#1>.

No contract involving the use of Federal funds may be awarded to any vendor unless and until such registration is current and in good standing under SAM Successful vendors must maintain SAM registration throughout the entire term of any contractual agreement with the County. If a contract involves the use of Federal funds, then vendor must enclose proof of such SAM registration within its response, which is also a mandatory requirement of County procurement policy; failure to enclose such proof shall be considered non-compliant with the requirements of any procurement effort and grounds for the rejection of vendor's response to any procurement efforts (i.e., bid, proposal, or qualifications statement, as applicable).

Direct Deposit: Direct Deposit Authorization Form – Temporarily suspended until further notice

Certificate(s) of Insurance: If the person or entity seeking qualified vendor status with the County will be performing work at or on any County owned facility and/or property, Certificate(s) of Insurance are required to be submitted prior to performing any work.

Insurance requirements are as follows:

Public Liability and Property Damage Insurance:

Successful vendor agrees to keep in full force and effect, a policy of public liability and property damage insurance issued by a casualty company authorized to do business in the State of Texas, and in standard form approved by the Board of Insurance Commissioners of the State of Texas, with coverage provisions insuring the public from any loss or damage that may arise to any person or property by reason of services rendered by vendor. Vendor shall at its own expense be required to carry the following minimum insurance coverages:

1. For damages arising out of bodily injury to or death of one person in anyone occurrence - one hundred thousand and no/100 dollars (\$100,000.00);
2. For damages arising out of bodily injury to or death of two or more persons in anyone occurrence - three hundred thousand and no/100 dollars (\$300,000.00); and
3. For injury to or destruction of property in anyone occurrence - one hundred thousand and no/100 dollars (\$100,000.00).

This insurance shall be either on an occurrence basis or on a claims made basis. Provided however, that if the coverage is on a claims made basis, then the vendor shall be required to purchase, at the termination of this agreement, tail coverage for the County for the period of the County's relationship with the vendor under this agreement. Such coverage shall be in the amounts set forth in subparagraphs (1), (2), and (3) above.

Worker's Compensation Insurance:

Successful vendor shall also carry in full force Workers' Compensation Insurance policy(ies), if there is more than one employee, for all employees, including but not limited to full time, part time, and emergency employees employed by the vendor. Current insurance certificates certifying that such policies as specified above are in full force and effect shall be furnished by the vendor to the County.

The County of Galveston shall be named as additional insured on policies listed in subparagraphs above and shall be notified of any changes to the policy(ies) during the contractual period.

Insurance is to be placed with insurers having a Best rating of no less than A. The vendor shall furnish the County with certificates of insurance and original endorsements affecting coverage required by these insurance clauses. The certificates and endorsements for each insurance policy are to be signed by a person authorized by the insurer to bind coverage on its behalf. The vendor shall be required to submit annual renewals for the term of any contractual agreement, purchase order or term contract, with Galveston County prior to expiration of any policy.

In addition to the remedies stated herein, the County has the right to pursue other remedies permitted by law or in equity.

The County agrees to provide vendor with reasonable and timely notice of any claim, demand, or cause of action made or brought against the County arising out of or related to utilization of the property. Vendor shall have the right to defend any such claim, demand, or cause of action at its sole cost and expense and within its sole and exclusive discretion. The County agrees not to compromise or settle any claim or cause of action arising out of or related to the utilization of the property without the prior written consent of the vendor.

In no event shall the County be liable for any damage to or destruction of any property belonging to the vendor unless specified in writing and agreed upon by both parties.

Procurement Policy - Special Note:

Understand that it is, according to Texas Local Government Code, Section 262.011, Purchasing Agents, subsections (d), (e), and (0, the sole responsibility of the Purchasing Agent to supervise all procurement transactions.

Therefore, be advised that all procurement transactions require proper authorization in the form of a Galveston County purchase order from the Purchasing Agent's office prior to commitment to deliver supplies, materials, equipment, including contracts for repair, service, and maintenance agreements. Any commitments made without proper authorization from the Purchasing Agent's office, pending Commissioners' Court approval, may become the sole responsibility of the individual making the commitment including the obligation of payment.

Code of Ethics - Statement of Purchasing Policy:

Public employment is a public trust. It is the policy of Galveston County to promote and balance the objective of protecting the County's integrity and the objective of facilitating the recruitment and retention of personnel needed by Galveston County. Such policy is implemented by prescribing essential standards of ethical conduct without creating unnecessary obstacles to entering public office.

Public employees must discharge their duties impartially so as to assure fair competitive access to governmental procurement by responsible contractors. Moreover, they should conduct themselves in such a manner as to foster public confidence in the integrity of the Galveston County procurement organization.

To achieve the purpose of these instructions, it is essential that those doing business with Galveston County also observe the ethical standards prescribed here.

General Ethical Standards: It shall be a breach of ethics to attempt to realize personal gain through public employment with Galveston County by any conduct inconsistent with the proper discharge of the employee's duties.

It shall be a breach of ethics to attempt to influence any public employee of Galveston County to breach the standards of ethical conduct set forth in this code.

It shall be a breach of ethics for any employee of Galveston County to participate directly or indirectly in procurement when the employee knows that:

- The employee or any member of the employee's immediate family has a financial interest pertaining to the procurement.
- A business or organization in which the employee, or any member of the employee's immediate family, has a financial interest pertaining to the procurement.
- Any other person, business or organization with which the employee or any member of the employee's immediate family is negotiating or has an arrangement concerning prospective employment is involved in the procurement.

Gratuities: It shall be a breach of ethics to offer, give or agree to give any employee of Galveston County, or for any employee or former employee of Galveston County to solicit, demand, accept or agree to accept from another person, a gratuity or an offer of employment in connection with any decision, approval, disapproval, recommendation, preparation of any part of a program requirement or purchase request, influencing the content of any specification or procurement standard, rendering of advice, investigation, auditing, or in any other advisory capacity in any program requirement or a contract or subcontract, or to any solicitation or proposal therefore pending before this government.

Kickbacks: It shall be a breach of ethics for any payment, gratuity or offer of employment to be made by or on behalf of a subcontractor under a contract to the prime contractor or higher tier subcontractor for any contract for Galveston County, or any person associated therewith, as an inducement for the award of a subcontract or order.

Contract Clause: The prohibition against gratuities and kickbacks prescribed above shall be conspicuously set forth in every contract and solicitation by Galveston County.

Confidential Information: It shall be a breach of ethics for any employee or former employee of Galveston County to knowingly use confidential information for actual or anticipated personal gain, or for the actual or anticipated gain of any person.

Questions/Concerns:

If you have any questions or concerns regarding the information or instructions contained within this packet, please contact any member of the Purchasing Department staff at (409) 770-5371.

CONFLICT OF INTEREST DISCLOSURE REPORTING

Proposer may be required under Chapter 176 of the Texas Local Government Code to complete and file a conflict of interest questionnaire (CIQ Form). If so, the completed CIQ Form must be filed with the County Clerk of Galveston County, Texas.

If Proposer has an employment or other business relationship with an officer of Galveston County or with a family member of an officer of Galveston County that results in the officer or family member of the officer receiving taxable income that exceeds \$2,500.00 during the preceding 12-month period, then Proposer **MUST** complete a CIQ Form and file the original of the CIQ Form with the County Clerk of Galveston County.

If Proposer has given an officer of Galveston County or a family member of an officer of Galveston County one or more gifts with an aggregate value of more than \$250.00 during the preceding 12-months, then Proposer **MUST** complete a CIQ Form and file the original of the CIQ Form with the County Clerk of Galveston County

The Galveston County Clerk has offices at the following locations:

Galveston County Clerk
Galveston County Justice Center, Suite 2001
600 59th Street
Galveston, Texas 77551

Galveston County Clerk
North County Annex, 1st Floor
174 Calder Road
League City, Texas 77573

Again, if Proposer is required to file a CIQ Form, the original completed form is filed with the Galveston County Clerk (not the Purchasing Agent).

For Proposer's convenience, a blank CIQ Form is enclosed with this proposal. Blank CIQ Forms may also be obtained by visiting the Galveston County Clerk's website and/or the Purchasing Agent's website - both of these web sites are linked to the Galveston County homepage at <http://www.galvestoncountytx.gov>

As well, blank CIQ Forms may be obtained by visiting the Texas Ethics Commission website, specifically at <http://www.ethics.state.tx.us/whatsnew/conflictforms.htm>

Chapter 176 specifies deadlines for the filing of CIQ Forms (both initial filings and updated filings).

It is Proposer's sole responsibility to file a true and complete CIQ Form with the Galveston County Clerk if Proposer is required to file by the requirements of Chapter 176. Proposer is advised that it is an offense to fail to comply with the disclosure reporting requirements dictated under Chapter 176 of the Texas Local Government Code.

If you have questions about compliance with Chapter 176, please consult your own legal counsel. Compliance is the individual responsibility of each person, business, and agent who is subject to Chapter 176 of the Texas Local Government Code.



COUNTY of GALVESTON
Purchasing Department

rev. 1.3, March 29, 2010

FORM PEID:	Request for Person-Entity Identification Data
-------------------	--

Instructions: Please type or print clearly when completing sections 1 thru 4 and return completed form to:

Galveston County Purchasing Agent
722 Moody Avenue (21 st. Street), 5th Floor
Galveston, Texas 77550
(409) 770-5371
prodoc@co.galveston.tx.us

1.	Business Name:			
	Attention Line:			
2.	Physical Address:			
	City:	State:	Zip+4:	
3.	Billing / Remit Address:			
	City:	State:	Zip+4	
4.	Main Contact Person:			
	Main Phone Number:			
	Fax Number:			
	E-mail Address:			

Areas below are for County use only.

Requested By:	Phone / Ext. #
Department:	Date:
Action Requested - Check One:	IFAS PEID Vendor Number:
<input type="checkbox"/> Add New	<input type="checkbox"/> Change Data <input type="checkbox"/> Re-activate
<input type="checkbox"/> Inactivate	<input type="checkbox"/> Employee <input type="checkbox"/> Attorney
<input type="checkbox"/> Landlord	<input type="checkbox"/> Foster Parent <input type="checkbox"/> Refund
<input type="checkbox"/> OneTime	<input type="checkbox"/> Foster Child

Request for Taxpayer Identification Number and Certification

Give Form to the requester. Do not send to the IRS.

▶ Go to www.irs.gov/FormW9 for instructions and the latest information.

Print or type. See Specific Instructions on page 3.	1 Name (as shown on your income tax return). Name is required on this line; do not leave this line blank.	
	2 Business name/disregarded entity name, if different from above	
	3 Check appropriate box for federal tax classification of the person whose name is entered on line 1. Check only one of the following seven boxes. <input type="checkbox"/> Individual/sole proprietor or single-member LLC <input type="checkbox"/> C Corporation <input type="checkbox"/> S Corporation <input type="checkbox"/> Partnership <input type="checkbox"/> Trust/estate <input type="checkbox"/> Limited liability company. Enter the tax classification (C=C corporation, S=S corporation, P=Partnership) ▶ _____ Note: Check the appropriate box in the line above for the tax classification of the single-member owner. Do not check LLC if the LLC is classified as a single-member LLC that is disregarded from the owner unless the owner of the LLC is another LLC that is not disregarded from the owner for U.S. federal tax purposes. Otherwise, a single-member LLC that is disregarded from the owner should check the appropriate box for the tax classification of its owner. <input type="checkbox"/> Other (see instructions) ▶ _____	4 Exemptions (codes apply only to certain entities, not individuals; see instructions on page 3): Exempt payee code (if any) _____ Exemption from FATCA reporting code (if any) _____ <small>(Applies to accounts maintained outside the U.S.)</small>
	5 Address (number, street, and apt. or suite no.) See instructions.	Requester's name and address (optional)
	6 City, state, and ZIP code	
	7 List account number(s) here (optional)	

Part I Taxpayer Identification Number (TIN) Enter your TIN in the appropriate box. The TIN provided must match the name given on line 1 to avoid backup withholding. For individuals, this is generally your social security number (SSN). However, for a resident alien, sole proprietor, or disregarded entity, see the instructions for Part I, later. For other entities, it is your employer identification number (EIN). If you do not have a number, see <i>How to get a TIN</i> , later. Note: If the account is in more than one name, see the instructions for line 1. Also see <i>What Name and Number To Give the Requester</i> for guidelines on whose number to enter.	<table border="1" style="width: 100%; border-collapse: collapse;"> <tr> <td colspan="2" style="text-align: center;">Social security number</td> </tr> <tr> <td style="text-align: center;"> <table style="width: 100%; border-collapse: collapse;"> <tr> <td style="border: 1px solid black; width: 25px; height: 25px;"> </td> <td style="border: 1px solid black; width: 25px; height: 25px;"> </td> <td style="border: 1px solid black; width: 25px; height: 25px;"> </td> <td style="border: 1px solid black; width: 25px; height: 25px;"> </td> <td style="border: 1px solid black; width: 25px; height: 25px;"> </td> <td style="border: 1px solid black; width: 25px; height: 25px;"> </td> <td style="border: 1px solid black; width: 25px; height: 25px;"> </td> <td style="border: 1px solid black; width: 25px; height: 25px;"> </td> </tr> </table> </td> <td style="text-align: center; vertical-align: middle;">-</td> <td style="text-align: center; vertical-align: middle;">-</td> <td style="border: 1px solid black; width: 25px; height: 25px;"> </td> <td style="border: 1px solid black; width: 25px; height: 25px;"> </td> <td style="border: 1px solid black; width: 25px; height: 25px;"> </td> <td style="border: 1px solid black; width: 25px; height: 25px;"> </td> <td style="border: 1px solid black; width: 25px; height: 25px;"> </td> </tr> <tr> <td colspan="2" style="text-align: center;">or</td> </tr> <tr> <td colspan="2" style="text-align: center;">Employer identification number</td> </tr> <tr> <td style="border: 1px solid black; width: 25px; height: 25px;"> </td> <td style="border: 1px solid black; width: 25px; height: 25px;"> </td> <td style="border: 1px solid black; width: 25px; height: 25px;"> </td> <td style="border: 1px solid black; width: 25px; height: 25px;"> </td> <td style="border: 1px solid black; width: 25px; height: 25px;"> </td> <td style="border: 1px solid black; width: 25px; height: 25px;"> </td> <td style="border: 1px solid black; width: 25px; height: 25px;"> </td> <td style="border: 1px solid black; width: 25px; height: 25px;"> </td> <td style="border: 1px solid black; width: 25px; height: 25px;"> </td> <td style="border: 1px solid black; width: 25px; height: 25px;"> </td> <td style="border: 1px solid black; width: 25px; height: 25px;"> </td> <td style="border: 1px solid black; width: 25px; height: 25px;"> </td> </tr> </table>	Social security number		<table style="width: 100%; border-collapse: collapse;"> <tr> <td style="border: 1px solid black; width: 25px; height: 25px;"> </td> <td style="border: 1px solid black; width: 25px; height: 25px;"> </td> <td style="border: 1px solid black; width: 25px; height: 25px;"> </td> <td style="border: 1px solid black; width: 25px; height: 25px;"> </td> <td style="border: 1px solid black; width: 25px; height: 25px;"> </td> <td style="border: 1px solid black; width: 25px; height: 25px;"> </td> <td style="border: 1px solid black; width: 25px; height: 25px;"> </td> <td style="border: 1px solid black; width: 25px; height: 25px;"> </td> </tr> </table>									-	-						or		Employer identification number													
Social security number																																			
<table style="width: 100%; border-collapse: collapse;"> <tr> <td style="border: 1px solid black; width: 25px; height: 25px;"> </td> <td style="border: 1px solid black; width: 25px; height: 25px;"> </td> <td style="border: 1px solid black; width: 25px; height: 25px;"> </td> <td style="border: 1px solid black; width: 25px; height: 25px;"> </td> <td style="border: 1px solid black; width: 25px; height: 25px;"> </td> <td style="border: 1px solid black; width: 25px; height: 25px;"> </td> <td style="border: 1px solid black; width: 25px; height: 25px;"> </td> <td style="border: 1px solid black; width: 25px; height: 25px;"> </td> </tr> </table>									-	-																									
or																																			
Employer identification number																																			

Part II Certification Under penalties of perjury, I certify that: 1. The number shown on this form is my correct taxpayer identification number (or I am waiting for a number to be issued to me); and 2. I am not subject to backup withholding because: (a) I am exempt from backup withholding, or (b) I have not been notified by the Internal Revenue Service (IRS) that I am subject to backup withholding as a result of a failure to report all interest or dividends, or (c) the IRS has notified me that I am no longer subject to backup withholding; and 3. I am a U.S. citizen or other U.S. person (defined below); and 4. The FATCA code(s) entered on this form (if any) indicating that I am exempt from FATCA reporting is correct. Certification instructions. You must cross out item 2 above if you have been notified by the IRS that you are currently subject to backup withholding because you have failed to report all interest and dividends on your tax return. For real estate transactions, item 2 does not apply. For mortgage interest paid, acquisition or abandonment of secured property, cancellation of debt, contributions to an individual retirement arrangement (IRA), and generally, payments other than interest and dividends, you are not required to sign the certification, but you must provide your correct TIN. See the instructions for Part II, later.	
---	--

Sign Here	Signature of U.S. person ▶ _____	Date ▶ _____
------------------	----------------------------------	--------------

General Instructions

Section references are to the Internal Revenue Code unless otherwise noted.

Future developments. For the latest information about developments related to Form W-9 and its instructions, such as legislation enacted after they were published, go to www.irs.gov/FormW9.

Purpose of Form

An individual or entity (Form W-9 requester) who is required to file an information return with the IRS must obtain your correct taxpayer identification number (TIN) which may be your social security number (SSN), individual taxpayer identification number (ITIN), adoption taxpayer identification number (ATIN), or employer identification number (EIN), to report on an information return the amount paid to you, or other amount reportable on an information return. Examples of information returns include, but are not limited to, the following.

- Form 1099-INT (interest earned or paid)

- Form 1099-DIV (dividends, including those from stocks or mutual funds)
 - Form 1099-MISC (various types of income, prizes, awards, or gross proceeds)
 - Form 1099-B (stock or mutual fund sales and certain other transactions by brokers)
 - Form 1099-S (proceeds from real estate transactions)
 - Form 1099-K (merchant card and third party network transactions)
 - Form 1098 (home mortgage interest), 1098-E (student loan interest), 1098-T (tuition)
 - Form 1099-C (canceled debt)
 - Form 1099-A (acquisition or abandonment of secured property)
- Use Form W-9 only if you are a U.S. person (including a resident alien), to provide your correct TIN.
- If you do not return Form W-9 to the requester with a TIN, you might be subject to backup withholding. See What is backup withholding, later.*

By signing the filled-out form, you:

1. Certify that the TIN you are giving is correct (or you are waiting for a number to be issued),
2. Certify that you are not subject to backup withholding, or
3. Claim exemption from backup withholding if you are a U.S. exempt payee. If applicable, you are also certifying that as a U.S. person, your allocable share of any partnership income from a U.S. trade or business is not subject to the withholding tax on foreign partners' share of effectively connected income, and
4. Certify that FATCA code(s) entered on this form (if any) indicating that you are exempt from the FATCA reporting, is correct. See *What is FATCA reporting*, later, for further information.

Note: If you are a U.S. person and a requester gives you a form other than Form W-9 to request your TIN, you must use the requester's form if it is substantially similar to this Form W-9.

Definition of a U.S. person. For federal tax purposes, you are considered a U.S. person if you are:

- An individual who is a U.S. citizen or U.S. resident alien;
- A partnership, corporation, company, or association created or organized in the United States or under the laws of the United States;
- An estate (other than a foreign estate); or
- A domestic trust (as defined in Regulations section 301.7701-7).

Special rules for partnerships. Partnerships that conduct a trade or business in the United States are generally required to pay a withholding tax under section 1446 on any foreign partners' share of effectively connected taxable income from such business. Further, in certain cases where a Form W-9 has not been received, the rules under section 1446 require a partnership to presume that a partner is a foreign person, and pay the section 1446 withholding tax. Therefore, if you are a U.S. person that is a partner in a partnership conducting a trade or business in the United States, provide Form W-9 to the partnership to establish your U.S. status and avoid section 1446 withholding on your share of partnership income.

In the cases below, the following person must give Form W-9 to the partnership for purposes of establishing its U.S. status and avoiding withholding on its allocable share of net income from the partnership conducting a trade or business in the United States.

- In the case of a disregarded entity with a U.S. owner, the U.S. owner of the disregarded entity and not the entity;
- In the case of a grantor trust with a U.S. grantor or other U.S. owner, generally, the U.S. grantor or other U.S. owner of the grantor trust and not the trust; and
- In the case of a U.S. trust (other than a grantor trust), the U.S. trust (other than a grantor trust) and not the beneficiaries of the trust.

Foreign person. If you are a foreign person or the U.S. branch of a foreign bank that has elected to be treated as a U.S. person, do not use Form W-9. Instead, use the appropriate Form W-8 or Form 8233 (see Pub. 515, *Withholding of Tax on Nonresident Aliens and Foreign Entities*).

Nonresident alien who becomes a resident alien. Generally, only a nonresident alien individual may use the terms of a tax treaty to reduce or eliminate U.S. tax on certain types of income. However, most tax treaties contain a provision known as a "saving clause." Exceptions specified in the saving clause may permit an exemption from tax to continue for certain types of income even after the payee has otherwise become a U.S. resident alien for tax purposes.

If you are a U.S. resident alien who is relying on an exception contained in the saving clause of a tax treaty to claim an exemption from U.S. tax on certain types of income, you must attach a statement to Form W-9 that specifies the following five items.

1. The treaty country. Generally, this must be the same treaty under which you claimed exemption from tax as a nonresident alien.
2. The treaty article addressing the income.
3. The article number (or location) in the tax treaty that contains the saving clause and its exceptions.
4. The type and amount of income that qualifies for the exemption from tax.
5. Sufficient facts to justify the exemption from tax under the terms of the treaty article.

Example. Article 20 of the U.S.-China income tax treaty allows an exemption from tax for scholarship income received by a Chinese student temporarily present in the United States. Under U.S. law, this student will become a resident alien for tax purposes if his or her stay in the United States exceeds 5 calendar years. However, paragraph 2 of the first Protocol to the U.S.-China treaty (dated April 30, 1984) allows the provisions of Article 20 to continue to apply even after the Chinese student becomes a resident alien of the United States. A Chinese student who qualifies for this exception (under paragraph 2 of the first protocol) and is relying on this exception to claim an exemption from tax on his or her scholarship or fellowship income would attach to Form W-9 a statement that includes the information described above to support that exemption.

If you are a nonresident alien or a foreign entity, give the requester the appropriate completed Form W-8 or Form 8233.

Backup Withholding

What is backup withholding? Persons making certain payments to you must under certain conditions withhold and pay to the IRS 24% of such payments. This is called "backup withholding." Payments that may be subject to backup withholding include interest, tax-exempt interest, dividends, broker and barter exchange transactions, rents, royalties, nonemployee pay, payments made in settlement of payment card and third party network transactions, and certain payments from fishing boat operators. Real estate transactions are not subject to backup withholding.

You will not be subject to backup withholding on payments you receive if you give the requester your correct TIN, make the proper certifications, and report all your taxable interest and dividends on your tax return.

Payments you receive will be subject to backup withholding if:

1. You do not furnish your TIN to the requester,
2. You do not certify your TIN when required (see the instructions for Part II for details),
3. The IRS tells the requester that you furnished an incorrect TIN,
4. The IRS tells you that you are subject to backup withholding because you did not report all your interest and dividends on your tax return (for reportable interest and dividends only), or
5. You do not certify to the requester that you are not subject to backup withholding under 4 above (for reportable interest and dividend accounts opened after 1983 only).

Certain payees and payments are exempt from backup withholding. See *Exempt payee code*, later, and the separate Instructions for the Requester of Form W-9 for more information.

Also see *Special rules for partnerships*, earlier.

What is FATCA Reporting?

The Foreign Account Tax Compliance Act (FATCA) requires a participating foreign financial institution to report all United States account holders that are specified United States persons. Certain payees are exempt from FATCA reporting. See *Exemption from FATCA reporting code*, later, and the Instructions for the Requester of Form W-9 for more information.

Updating Your Information

You must provide updated information to any person to whom you claimed to be an exempt payee if you are no longer an exempt payee and anticipate receiving reportable payments in the future from this person. For example, you may need to provide updated information if you are a C corporation that elects to be an S corporation, or if you no longer are tax exempt. In addition, you must furnish a new Form W-9 if the name or TIN changes for the account; for example, if the grantor of a grantor trust dies.

Penalties

Failure to furnish TIN. If you fail to furnish your correct TIN to a requester, you are subject to a penalty of \$50 for each such failure unless your failure is due to reasonable cause and not to willful neglect.

Civil penalty for false information with respect to withholding. If you make a false statement with no reasonable basis that results in no backup withholding, you are subject to a \$500 penalty.

Criminal penalty for falsifying information. Willfully falsifying certifications or affirmations may subject you to criminal penalties including fines and/or imprisonment.

Misuse of TINs. If the requester discloses or uses TINs in violation of federal law, the requester may be subject to civil and criminal penalties.

Specific Instructions

Line 1

You must enter one of the following on this line; **do not** leave this line blank. The name should match the name on your tax return.

If this Form W-9 is for a joint account (other than an account maintained by a foreign financial institution (FFI)), list first, and then circle, the name of the person or entity whose number you entered in Part I of Form W-9. If you are providing Form W-9 to an FFI to document a joint account, each holder of the account that is a U.S. person must provide a Form W-9.

a. **Individual.** Generally, enter the name shown on your tax return. If you have changed your last name without informing the Social Security Administration (SSA) of the name change, enter your first name, the last name as shown on your social security card, and your new last name.

Note: ITIN applicant: Enter your individual name as it was entered on your Form W-7 application, line 1a. This should also be the same as the name you entered on the Form 1040/1040A/1040EZ you filed with your application.

b. **Sole proprietor or single-member LLC.** Enter your individual name as shown on your 1040/1040A/1040EZ on line 1. You may enter your business, trade, or "doing business as" (DBA) name on line 2.

c. **Partnership, LLC that is not a single-member LLC, C corporation, or S corporation.** Enter the entity's name as shown on the entity's tax return on line 1 and any business, trade, or DBA name on line 2.

d. **Other entities.** Enter your name as shown on required U.S. federal tax documents on line 1. This name should match the name shown on the charter or other legal document creating the entity. You may enter any business, trade, or DBA name on line 2.

e. **Disregarded entity.** For U.S. federal tax purposes, an entity that is disregarded as an entity separate from its owner is treated as a "disregarded entity." See Regulations section 301.7701-2(c)(2)(iii). Enter the owner's name on line 1. The name of the entity entered on line 1 should never be a disregarded entity. The name on line 1 should be the name shown on the income tax return on which the income should be reported. For example, if a foreign LLC that is treated as a disregarded entity for U.S. federal tax purposes has a single owner that is a U.S. person, the U.S. owner's name is required to be provided on line 1. If the direct owner of the entity is also a disregarded entity, enter the first owner that is not disregarded for federal tax purposes. Enter the disregarded entity's name on line 2, "Business name/disregarded entity name." If the owner of the disregarded entity is a foreign person, the owner must complete an appropriate Form W-8 instead of a Form W-9. This is the case even if the foreign person has a U.S. TIN.

Line 2

If you have a business name, trade name, DBA name, or disregarded entity name, you may enter it on line 2.

Line 3

Check the appropriate box on line 3 for the U.S. federal tax classification of the person whose name is entered on line 1. Check only one box on line 3.

IF the entity/person on line 1 is a(n) . . .	THEN check the box for . . .
• Corporation	Corporation
• Individual • Sole proprietorship, or • Single-member limited liability company (LLC) owned by an individual and disregarded for U.S. federal tax purposes.	Individual/sole proprietor or single-member LLC
• LLC treated as a partnership for U.S. federal tax purposes, • LLC that has filed Form 8832 or 2553 to be taxed as a corporation, or • LLC that is disregarded as an entity separate from its owner but the owner is another LLC that is not disregarded for U.S. federal tax purposes.	Limited liability company and enter the appropriate tax classification. (P= Partnership; C= C corporation; or S= S corporation)
• Partnership	Partnership
• Trust/estate	Trust/estate

Line 4, Exemptions

If you are exempt from backup withholding and/or FATCA reporting, enter in the appropriate space on line 4 any code(s) that may apply to you.

Exempt payee code.

- Generally, individuals (including sole proprietors) are not exempt from backup withholding.
- Except as provided below, corporations are exempt from backup withholding for certain payments, including interest and dividends.
- Corporations are not exempt from backup withholding for payments made in settlement of payment card or third party network transactions.
- Corporations are not exempt from backup withholding with respect to attorneys' fees or gross proceeds paid to attorneys, and corporations that provide medical or health care services are not exempt with respect to payments reportable on Form 1099-MISC.

The following codes identify payees that are exempt from backup withholding. Enter the appropriate code in the space in line 4.

- 1—An organization exempt from tax under section 501(a), any IRA, or a custodial account under section 403(b)(7) if the account satisfies the requirements of section 401(f)(2)
- 2—The United States or any of its agencies or instrumentalities
- 3—A state, the District of Columbia, a U.S. commonwealth or possession, or any of their political subdivisions or instrumentalities
- 4—A foreign government or any of its political subdivisions, agencies, or instrumentalities
- 5—A corporation
- 6—A dealer in securities or commodities required to register in the United States, the District of Columbia, or a U.S. commonwealth or possession
- 7—A futures commission merchant registered with the Commodity Futures Trading Commission
- 8—A real estate investment trust
- 9—An entity registered at all times during the tax year under the Investment Company Act of 1940
- 10—A common trust fund operated by a bank under section 584(a)
- 11—A financial institution
- 12—A middleman known in the investment community as a nominee or custodian
- 13—A trust exempt from tax under section 664 or described in section 4947

The following chart shows types of payments that may be exempt from backup withholding. The chart applies to the exempt payees listed above, 1 through 13.

IF the payment is for . . .	THEN the payment is exempt for . . .
Interest and dividend payments	All exempt payees except for 7
Broker transactions	Exempt payees 1 through 4 and 6 through 11 and all C corporations. S corporations must not enter an exempt payee code because they are exempt only for sales of noncovered securities acquired prior to 2012.
Barter exchange transactions and patronage dividends	Exempt payees 1 through 4
Payments over \$600 required to be reported and direct sales over \$5,000 ¹	Generally, exempt payees 1 through 5 ²
Payments made in settlement of payment card or third party network transactions	Exempt payees 1 through 4

¹ See Form 1099-MISC, Miscellaneous Income, and its instructions.

² However, the following payments made to a corporation and reportable on Form 1099-MISC are not exempt from backup withholding: medical and health care payments, attorneys' fees, gross proceeds paid to an attorney reportable under section 6045(f), and payments for services paid by a federal executive agency.

Exemption from FATCA reporting code. The following codes identify payees that are exempt from reporting under FATCA. These codes apply to persons submitting this form for accounts maintained outside of the United States by certain foreign financial institutions. Therefore, if you are only submitting this form for an account you hold in the United States, you may leave this field blank. Consult with the person requesting this form if you are uncertain if the financial institution is subject to these requirements. A requester may indicate that a code is not required by providing you with a Form W-9 with "Not Applicable" (or any similar indication) written or printed on the line for a FATCA exemption code.

A—An organization exempt from tax under section 501(a) or any individual retirement plan as defined in section 7701(a)(37)

B—The United States or any of its agencies or instrumentalities

C—A state, the District of Columbia, a U.S. commonwealth or possession, or any of their political subdivisions or instrumentalities

D—A corporation the stock of which is regularly traded on one or more established securities markets, as described in Regulations section 1.1472-1(c)(1)(i)

E—A corporation that is a member of the same expanded affiliated group as a corporation described in Regulations section 1.1472-1(c)(1)(i)

F—A dealer in securities, commodities, or derivative financial instruments (including notional principal contracts, futures, forwards, and options) that is registered as such under the laws of the United States or any state

G—A real estate investment trust

H—A regulated investment company as defined in section 851 or an entity registered at all times during the tax year under the Investment Company Act of 1940

I—A common trust fund as defined in section 584(a)

J—A bank as defined in section 581

K—A broker

L—A trust exempt from tax under section 664 or described in section 4947(a)(1)

M—A tax exempt trust under a section 403(b) plan or section 457(g) plan

Note: You may wish to consult with the financial institution requesting this form to determine whether the FATCA code and/or exempt payee code should be completed.

Line 5

Enter your address (number, street, and apartment or suite number). This is where the requester of this Form W-9 will mail your information returns. If this address differs from the one the requester already has on file, write NEW at the top. If a new address is provided, there is still a chance the old address will be used until the payor changes your address in their records.

Line 6

Enter your city, state, and ZIP code.

Part I. Taxpayer Identification Number (TIN)

Enter your TIN in the appropriate box. If you are a resident alien and you do not have and are not eligible to get an SSN, your TIN is your IRS individual taxpayer identification number (ITIN). Enter it in the social security number box. If you do not have an ITIN, see *How to get a TIN* below.

If you are a sole proprietor and you have an EIN, you may enter either your SSN or EIN.

If you are a single-member LLC that is disregarded as an entity separate from its owner, enter the owner's SSN (or EIN, if the owner has one). Do not enter the disregarded entity's EIN. If the LLC is classified as a corporation or partnership, enter the entity's EIN.

Note: See *What Name and Number To Give the Requester*, later, for further clarification of name and TIN combinations.

How to get a TIN. If you do not have a TIN, apply for one immediately. To apply for an SSN, get Form SS-5, Application for a Social Security Card, from your local SSA office or get this form online at www.SSA.gov. You may also get this form by calling 1-800-772-1213. Use Form W-7, Application for IRS Individual Taxpayer Identification Number, to apply for an ITIN, or Form SS-4, Application for Employer Identification Number, to apply for an EIN. You can apply for an EIN online by accessing the IRS website at www.irs.gov/Businesses and clicking on Employer Identification Number (EIN) under Starting a Business. Go to www.irs.gov/Forms to view, download, or print Form W-7 and/or Form SS-4. Or, you can go to www.irs.gov/OrderForms to place an order and have Form W-7 and/or SS-4 mailed to you within 10 business days.

If you are asked to complete Form W-9 but do not have a TIN, apply for a TIN and write "Applied For" in the space for the TIN, sign and date the form, and give it to the requester. For interest and dividend payments, and certain payments made with respect to readily tradable instruments, generally you will have 60 days to get a TIN and give it to the requester before you are subject to backup withholding on payments. The 60-day rule does not apply to other types of payments. You will be subject to backup withholding on all such payments until you provide your TIN to the requester.

Note: Entering "Applied For" means that you have already applied for a TIN or that you intend to apply for one soon.

Caution: A disregarded U.S. entity that has a foreign owner must use the appropriate Form W-8.

Part II. Certification

To establish to the withholding agent that you are a U.S. person, or resident alien, sign Form W-9. You may be requested to sign by the withholding agent even if item 1, 4, or 5 below indicates otherwise.

For a joint account, only the person whose TIN is shown in Part I should sign (when required). In the case of a disregarded entity, the person identified on line 1 must sign. Exempt payees, see *Exempt payee code*, earlier.

Signature requirements. Complete the certification as indicated in items 1 through 5 below.

1. Interest, dividend, and barter exchange accounts opened before 1984 and broker accounts considered active during 1983. You must give your correct TIN, but you do not have to sign the certification.

2. Interest, dividend, broker, and barter exchange accounts opened after 1983 and broker accounts considered inactive during 1983. You must sign the certification or backup withholding will apply. If you are subject to backup withholding and you are merely providing your correct TIN to the requester, you must cross out item 2 in the certification before signing the form.

3. Real estate transactions. You must sign the certification. You may cross out item 2 of the certification.

4. Other payments. You must give your correct TIN, but you do not have to sign the certification unless you have been notified that you have previously given an incorrect TIN. "Other payments" include payments made in the course of the requester's trade or business for rents, royalties, goods (other than bills for merchandise), medical and health care services (including payments to corporations), payments to a nonemployee for services, payments made in settlement of payment card and third party network transactions, payments to certain fishing boat crew members and fishermen, and gross proceeds paid to attorneys (including payments to corporations).

5. Mortgage interest paid by you, acquisition or abandonment of secured property, cancellation of debt, qualified tuition program payments (under section 529), ABLE accounts (under section 529A), IRA, Coverdell ESA, Archer MSA or HSA contributions or distributions, and pension distributions. You must give your correct TIN, but you do not have to sign the certification.

What Name and Number To Give the Requester

For this type of account:	Give name and SSN of:
1. Individual	The individual
2. Two or more individuals (joint account) other than an account maintained by an FFI	The actual owner of the account or, if combined funds, the first individual on the account ¹
3. Two or more U.S. persons (joint account maintained by an FFI)	Each holder of the account
4. Custodial account of a minor (Uniform Gift to Minors Act)	The minor ²
5. a. The usual revocable savings trust (grantor is also trustee) b. So-called trust account that is not a legal or valid trust under state law	The grantor-trustee ¹ The actual owner ¹
6. Sole proprietorship or disregarded entity owned by an individual	The owner ³
7. Grantor trust filing under Optional Form 1099 Filing Method 1 (see Regulations section 1.671-4(b)(2)(i)(A))	The grantor [*]

For this type of account:	Give name and EIN of:
8. Disregarded entity not owned by an individual	The owner
9. A valid trust, estate, or pension trust	Legal entity ⁴
10. Corporation or LLC electing corporate status on Form 8832 or Form 2553	The corporation
11. Association, club, religious, charitable, educational, or other tax-exempt organization	The organization
12. Partnership or multi-member LLC	The partnership
13. A broker or registered nominee	The broker or nominee

For this type of account:	Give name and EIN of:
14. Account with the Department of Agriculture in the name of a public entity (such as a state or local government, school district, or prison) that receives agricultural program payments	The public entity
15. Grantor trust filing under the Form 1041 Filing Method or the Optional Form 1099 Filing Method 2 (see Regulations section 1.671-4(b)(2)(i)(B))	The trust

¹ List first and circle the name of the person whose number you furnish. If only one person on a joint account has an SSN, that person's number must be furnished.

² Circle the minor's name and furnish the minor's SSN.

³ You must show your individual name and you may also enter your business or DBA name on the "Business name/disregarded entity" name line. You may use either your SSN or EIN (if you have one), but the IRS encourages you to use your SSN.

⁴ List first and circle the name of the trust, estate, or pension trust. (Do not furnish the TIN of the personal representative or trustee unless the legal entity itself is not designated in the account title.) Also see *Special rules for partnerships*, earlier.

***Note:** The grantor also must provide a Form W-9 to trustee of trust.

Note: If no name is circled when more than one name is listed, the number will be considered to be that of the first name listed.

Secure Your Tax Records From Identity Theft

Identity theft occurs when someone uses your personal information such as your name, SSN, or other identifying information, without your permission, to commit fraud or other crimes. An identity thief may use your SSN to get a job or may file a tax return using your SSN to receive a refund.

To reduce your risk:

- Protect your SSN,
- Ensure your employer is protecting your SSN, and
- Be careful when choosing a tax preparer.

If your tax records are affected by identity theft and you receive a notice from the IRS, respond right away to the name and phone number printed on the IRS notice or letter.

If your tax records are not currently affected by identity theft but you think you are at risk due to a lost or stolen purse or wallet, questionable credit card activity or credit report, contact the IRS Identity Theft Hotline at 1-800-908-4490 or submit Form 14039.

For more information, see Pub. 5027, Identity Theft Information for Taxpayers.

Victims of identity theft who are experiencing economic harm or a systemic problem, or are seeking help in resolving tax problems that have not been resolved through normal channels, may be eligible for Taxpayer Advocate Service (TAS) assistance. You can reach TAS by calling the TAS toll-free case intake line at 1-877-777-4778 or TTY/TDD 1-800-829-4059.

Protect yourself from suspicious emails or phishing schemes.

Phishing is the creation and use of email and websites designed to mimic legitimate business emails and websites. The most common act is sending an email to a user falsely claiming to be an established legitimate enterprise in an attempt to scam the user into surrendering private information that will be used for identity theft.

The IRS does not initiate contacts with taxpayers via emails. Also, the IRS does not request personal detailed information through email or ask taxpayers for the PIN numbers, passwords, or similar secret access information for their credit card, bank, or other financial accounts.

If you receive an unsolicited email claiming to be from the IRS, forward this message to phishing@irs.gov. You may also report misuse of the IRS name, logo, or other IRS property to the Treasury Inspector General for Tax Administration (TIGTA) at 1-800-366-4484. You can forward suspicious emails to the Federal Trade Commission at spam@uce.gov or report them at www.ftc.gov/complaint. You can contact the FTC at www.ftc.gov/idtheft or 877-IDTHEFT (877-438-4338). If you have been the victim of identity theft, see www.IdentityTheft.gov and Pub. 5027.

Visit www.irs.gov/IdentityTheft to learn more about identity theft and how to reduce your risk.

Privacy Act Notice

Section 6109 of the Internal Revenue Code requires you to provide your correct TIN to persons (including federal agencies) who are required to file information returns with the IRS to report interest, dividends, or certain other income paid to you; mortgage interest you paid; the acquisition or abandonment of secured property; the cancellation of debt; or contributions you made to an IRA, Archer MSA, or HSA. The person collecting this form uses the information on the form to file information returns with the IRS, reporting the above information. Routine uses of this information include giving it to the Department of Justice for civil and criminal litigation and to cities, states, the District of Columbia, and U.S. commonwealths and possessions for use in administering their laws. The information also may be disclosed to other countries under a treaty, to federal and state agencies to enforce civil and criminal laws, or to federal law enforcement and intelligence agencies to combat terrorism. You must provide your TIN whether or not you are required to file a tax return. Under section 3406, payers must generally withhold a percentage of taxable interest, dividend, and certain other payments to a payee who does not give a TIN to the payer. Certain penalties may also apply for providing false or fraudulent information.

CONFLICT OF INTEREST QUESTIONNAIRE

FORM CIQ

For vendor or other person doing business with local governmental entity

This questionnaire reflects changes made to the law by H.B. 1491, 80th Leg., Regular Session.

This questionnaire is being filed in accordance with Chapter 176, Local Government Code by a person who has a business relationship as defined by Section 176.001 (1-a) with a local governmental entity and the person meets requirements under Section 176.006(a).

By law this questionnaire must be filed with the records administrator of the local governmental entity not later than the 7th business day after the date the person becomes aware of facts that require the statement to be filed. See Section 176.006, Local Government Code.

A person commits an offense if the person knowingly violates Section 176.006, Local Government Code. An offense under this section is a Class C misdemeanor.

OFFICE USE ONLY

Date Received

1 Name of person who has a business relationship with local governmental entity.

2 Check this box if you are filing an update to a previously filed questionnaire.

(The law requires that you file an updated completed questionnaire with the appropriate filing authority not later than the 7th business day after the date the originally filed questionnaire becomes incomplete or inaccurate.)

3 Name of local government officer with whom filer has employment or business relationship.

Name of Officer

This section (item 3 including subparts A, B, C & D) must be completed for each *officer* with whom the filer has an employment or other business relationship as defined by Section 176.001 (1-a), Local Government Code. Attach additional pages to this Form CIQ as necessary.

A. Is the local government officer named in this section receiving or likely to receive taxable income, other than investment income, from the filer of the questionnaire?

Yes

NO

B. Is the filer of the questionnaire receiving or likely to receive taxable income, other than investment income, from or at the direction of the local government *officer* named in this section AND the taxable income is not received from the local governmental entity?

Yes

NO

C. Is the filer of this questionnaire employed by a corporation or other business entity with respect to which the local government officer serves as an *officer* or director, or holds an ownership of 10 percent or more?

Yes

NO

D. Describe each employment or business relationship with the local government *officer* named in this section.

4

Signature of person doing business with the governmental entity

Date



County of Galveston

ACKNOWLEDGMENT AND CERTIFICATION REGARDING DEBARMENT,
SUSPENSION, AND OTHER INELIGIBILITY

Executive Orders 12549 & 12689 Certification, Debarment and Suspension

Solicitation Number: RFP #B231010

Solicitation Title: Septic Tank Services-Runge Park

Contractor hereby CERTIFIES that:

Contractor, and all of its principals, is not presently debarred, suspended, proposed for debarment, proposed for suspension, or declared ineligible under Executive Order 12549 or Executive Order 12689, Debarment and Suspension, and is not in any other way ineligible for participation in Federal or State assistance programs;

Contractor, and all of its principals, were not and have not been debarred, suspended, proposed for debarment, proposed for suspension, or declared ineligible under Executive Order 12549 or Executive Order 12689, Debarment and Suspension, and were not and have not been in any other way ineligible for participation in Federal or State assistance programs at the time its' proposal was submitted in the procurement identified herein and at any time since submission of its' proposal;

Contractor has included, and shall continue to include, this certification in all contracts between itself and any sub-contractors in connection with services performed under this contract; **and**

Contractor shall notify Galveston County in writing immediately, through written notification to the Galveston County Purchasing Agent, if Contractor is not in compliance with Executive Order 12549 or 12689 during the term of its contract with Galveston County.

Contractor **Represents and Warrants** that the individual executing this Acknowledgment and Certification on its behalf has the full power and authority to do so and can legally bind the Contractor hereto.

Name of Business

Date

By: _____
Signature

Printed Name & Title