

**GALVESTON COUNTY
PURCHASING DEPARTMENT**

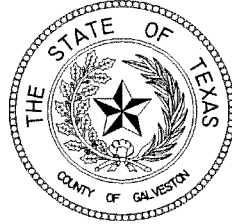

INVITATION TO BID

BID #B152013

SHERIFF DEPARTMENT UNIFORMS & SUPPLIES

BID DUE DATE: 08/13/2015

3:00 P.M.

*Rufus Crowder, CPPO, CPPB
Purchasing Agent
Galveston County
722 Moody (21st Street)
Fifth (5th) Floor
Galveston, Texas 77550
(409) 770-5372*



ITB #B152013
OPEN: 08/13/2015
TIME: 3:00 P.M.

INVITATION TO BID
SHERIFF DEPARTMENT UNIFORMS & SUPPLIES
GALVESTON COUNTY, TEXAS

Sealed bids in sets of four (4), one (1) original and three (3) copies will be received in the office of the County Purchasing Agent until 3:00 P.M. CST, on 08/13/2015 and opened immediately in that office in the presence of the Galveston County Auditor and the Purchasing Agent. Sealed bids are to be delivered to Rufus G. Crowder, CPPO CPPB, Galveston County Purchasing Agent at the Galveston County Courthouse, 722 Moody (21st Street), Floor 5, Purchasing, Galveston, Texas 77550, (409) 770-5372. **The time stamp clock located in the Purchasing Agent's office shall serve as the official time keeping piece for this solicitation process. Any bid received after 3:00 P.M. CST on the specified date will be returned unopened.**

Purpose:

Galveston County is seeking a vendor to supply uniforms and supplies for the Galveston County Sheriff's Office.

All bids must be marked on the outside of the envelope:

ITB #B152013

SHERIFF DEPARTMENT UNIFORMS & SUPPLIES

Bidders name, return address, and the enclosed label should be prominently displayed on the bid package for identification purposes.

Specifications can be obtained on application at the office of the Galveston County Purchasing Agent, located in the Galveston County Courthouse, 722 Moody, (21st Street), Floor 5, Purchasing, Galveston, Texas 77550, or by visiting the Galveston County website @ <http://www.galvestoncountytexas.gov/pu/Pages/BidListing.aspx>.

Bid prices shall be either lump sum or unit prices as shown on the proposal sheet, if applicable. The net price will be delivered to Galveston County, including all freight, shipping, and license fees. Galveston County is tax exempt and no taxes should be included in your proposal pricing.

Upon satisfaction of contractual terms (e.g., goods delivered in promised condition, services rendered as agreed, etc.), contractor shall be paid via Galveston County's normal accounts payable process.

Bond Requirement:

No bond is required with this Invitation to Bid.

The Galveston County Commissioners' Court reserves the right to waive any informality and to reject any and all bids and to accept the bid or bids which, in its opinion, is most advantageous to Galveston County with total respect the governing laws.

Rufus G. Crowder, CPPO CPPB
Purchasing Agent
Galveston County

**SHERIFF DEPARTMENT UNIFORMS & SUPPLIES
GALVESTON COUNTY, TEXAS**

Table of Contents

GENERAL PROVISIONS:

1.	BID PACKAGE	1
2.	BIDDER’S RESPONSIBILITY	1
3.	TIME FOR RECEIVING BIDS	1
4.	BID OPENING	1
5.	COMMISSIONERS’ COURT	1
6.	REJECTION OF BIDS/DISQUALIFICATION	2
	A.Failure to use the Bid form(s) furnished by the County;.....	2
7.	RESTRICTIVE OR AMBIGUOUS SPECIFICATIONS.....	2
8.	SUBSTITUTES/DESCRIPTION OF MATERIALS AND EQUIPMENT	2
9.	EXCEPTIONS TO BID	2
10.	PRICING	3
11.	PROCUREMENT CARD PROGRAM	3
12.	PASS THROUGH COST ADJUSTMENTS.....	3
13.	MODIFICATION OF BIDS	3
14.	SIGNATURE OF BIDS	4
15.	AWARD OF BIDS – EVALUATION CRITERIA AND FACTORS.....	4
16.	DISPUTE AFTER AWARD/PROTEST	5
17.	PUBLIC INFORMATION ACT.....	5
18.	BIDDER’S EMAIL ADDRESSES	5
19.	RESULTANT CONTRACT	5
20.	CONTRACT TERM.....	6
21.	TERMINATION FOR DEFAULT	6
22.	TERMINATION FOR CONVENIENCE	6
23.	FORCE MAJEURE.....	6
24.	ESTIMATED QUANTITIES	7
25.	CONTRACTOR INVESTIGATION.....	7

**SHERIFF DEPARTMENT UNIFORMS & SUPPLIES
GALVESTON COUNTY, TEXAS**

26.	NO COMMITMENT BY COUNTY OF GALVESTON.....	7
27.	BID COSTS BORNE BY BIDDER	7
28.	BEST AND FINAL OFFERS (BAFO)	7
29.	SINGLE BID RESPONSE.....	7
30.	CHANGES IN SPECIFICATIONS.....	7
31.	BID IDEAS AND CONCEPTS	8
32.	BID DISCLOSURES	8
33.	WITHDRAWAL OF BID	8
34.	INDEMNIFICATION	8
35.	REQUIREMENT OF AND PROOF OF INSURANCE	8
36.	PATENT AND COPYRIGHT PROTECTION	10
37.	CONFLICT OF INTEREST DISCLOSURE REPORTING	10
38.	COMPETITIVENESS AND INTEGRITY	11
39.	ENTIRETY OF AGREEMENT AND MODIFICATION	11
40.	NON-COLLUSION AFFIDAVIT	11
41.	SOVEREIGN IMMUNITY	12
42.	CONTROLLING LAW AND VENUE	12
43.	MERGERS, ACQUISITIONS	12
44.	DELAYS.....	12
45.	ACCURACY OF DATA.....	13
46.	SUBCONTRACTING/ASSIGNMENT.....	13
47.	INDEPENDENT CONTRACTOR.....	13
48.	MONITORING PERFORMANCE	13
49.	PROCUREMENT ETHICS	13
50.	SUBJECT TO APPROPRIATION OF FUNDS	14
51.	NOTICE.....	15
52.	NONDISCRIMINATION	15
53.	RECORD RETENTION AND RIGHT TO AUDIT.....	16
54.	TITLE VI ASSURANCES/TxDOT.....	16

**SHERIFF DEPARTMENT UNIFORMS & SUPPLIES
GALVESTON COUNTY, TEXAS**

55. CERTIFICATION REGARDING DEBARMENT, SUSPENSION, PROPOSED DEBARMENT, AND OTHER
RESPONSIBILITY MATTERS.....17

56. SECTION 231.006, FAMILY CODE/DELINQUENT CHILD SUPPORT18

57. LABOR STANDARDS18

SPECIAL PROVISIONS.....19-21

**GENERAL PROVISIONS
SHERIFF DEPARTMENT UNIFORMS & SUPPLIES
GALVESTON COUNTY, TEXAS**

1. BID PACKAGE:

The Invitation to Bid, general and special provisions, drawings, specifications/line item details, contract documents and the Bid sheet are all part of the Bid package. BIDs must be submitted in sets of four (4), one (1) original and three (3) copies on the forms provided by the County if provided, including the Bid sheets completed in their entirety and signed by an authorized representative by original signature. Failure to complete and sign the Bid sheets/contract page(s) may disqualify the Bid from being considered by the Commissioners' Court. Any individual signing on behalf of the Bidder expressly affirms that he or she is duly authorized to tender this Bid and to sign the Bid sheet/contract under the terms and conditions in this bid. Bidder further understands that the signing of the contract shall be of no effect unless subsequently awarded and the contract properly executed by the Commissioners' Court. All figures must be written in ink or typed. Figures written in pencil or with erasures are not acceptable. However, mistakes may be crossed out, corrections inserted, and initialed in ink by the individual signing the bid. If there are discrepancies between unit prices quoted and extensions, the unit price shall prevail. Each Bidder is required to thoroughly review this entire Bid package to familiarize themselves with the Bid procedures, the plans and specifications for the requested work, as well as the terms, and conditions of the contract the successful Bidder will execute with the County.

2. BIDDER'S RESPONSIBILITY

The Bidder must affirmatively demonstrate its responsibility. The Bidder must also meet the following minimum requirements:

- A. have adequate financial resources or the ability to obtain such resources as required;
- B. be able to comply with all federal, state, and local laws, rules, regulations, ordinances and orders regarding this Request for Bid;
- C. have a satisfactory record of performance;
- D. have a satisfactory record of integrity and ethics;
- E. and be otherwise qualified and eligible to receive an award.

The criteria utilized for determining responsibility of Bidder(s) includes, but is not limited to, the Bidder's experience, skill, ability, business judgment, financial capacity, integrity, honesty, possession of the necessary facilities or equipment, previous performance, reputation, promptness, and any other factor deemed relevant by the County. The Bidders shall furnish any information requested by the County in order for the County to determine whether a Bidder is responsible.

3. TIME FOR RECEIVING BIDS:

Bids received prior to the submission deadline will be maintained unopened until the specified time for opening. If the Bidder fails to identify the Bid Number on the outside of the envelope as required, the Purchasing Agent will open the envelope for the sole purpose of identifying the Bid number for which the submission was made. The envelope will then be resealed. No liability will attach to a County office or employee for the premature opening of a bid. If you do not submit a bid, return this Invitation to Bid and state reason, otherwise your name may be removed from the Purchasing Agent's mailing list.

4. BID OPENING:

Information read aloud at the bid opening is the sole discretion of the Purchasing Agent. The Purchasing Agent will examine Bids promptly and thoroughly. No Bid may be withdrawn for a period of sixty (60) calendar days of the Bid opening date.

5. COMMISSIONERS' COURT:

No contract is binding on the County until it is properly placed on the Commissioners' Court agenda, approved in open Court, authorized to be executed by the County Judge, and fully executed by both parties. Department heads and elected officials are not authorized to enter into any type of agreement or contract on behalf of the County. Only the Commissioners' Court acting as a body may enter into a contract on behalf of and contractually

**GENERAL PROVISIONS
SHERIFF DEPARTMENT UNIFORMS & SUPPLIES
GALVESTON COUNTY, TEXAS**

bind the County. Additionally, department heads and elected officials are not authorized to agree to any type of supplemental agreements or contracts for goods or services. Supplemental agreements are subject to review by the County Legal Department prior to being accepted and signed by the County's authorized representative.

6. REJECTION OF BIDS/DISQUALIFICATION:

Galveston County, acting through its Commissioners' Court, reserves the right to :

- reject any and all Bids in whole or in part received by reason of this request for bid;
- to waive any informality in the Bids received;
- to disregard the Bid of any Bidder determined to be not responsible and/or;
- to discontinue its efforts for any reason under this Bid package at any time prior to actual execution of contract by the County.

Bidders may be disqualified and rejection of Bids may be recommended to the Commissioners' Court for any of (but not limited to) the following causes:

- A. Lack of signature by an authorized representative on the Bid form(s);
- B. Failure to properly complete the Bid;
- C. Bids that do not meet the mandatory requirements; and/or;
- D. Evidence of collusion among Bidders.
- E. Failure to use the Bid form(s) furnished by the County.

7. RESTRICTIVE OR AMBIGUOUS SPECIFICATIONS:

It is the responsibility of the prospective Bidder to review the entire Invitation to Bid packet and to notify the Purchasing Department if the specifications are formulated in a manner that would restrict competition or appear ambiguous. Any protest or question(s) regarding the specifications or Bid procedures must be received in the Purchasing Department not less than seventy-two (72) hours prior to the time set for Bid opening. Vendors are to submit Bid as specified herein or propose an approved equal.

8. SUBSTITUTES/DESCRIPTION OF MATERIALS AND EQUIPMENT:

Any brand name or manufacturer reference used herein is intended to be descriptive and not restrictive, unless otherwise noted, and is used to indicate the type and quality of material. The term "or equal" if used, identifies commercially produced items that have the essential performance and salient characteristics of the brand name stated in the item description. All supplies, material, or equipment shall be new and of the most suitable grade for the purpose intended. It is not the County's intent to discriminate against any materials or equipment of equal merit to those specified. However, if Bidder desires to use any substitutions, prior written approval must be obtained from the County Purchasing Agent and sufficiently in advance such that an addendum may be issued. All material supplied must be one hundred percent (100%) asbestos free. Bidder, by submission of its bid, certifies that if awarded any portion of this procurement, the bidder will supply only material and equipment that is 100% asbestos free.

9. EXCEPTIONS TO BID:

The Bidder will list on a separate sheet of paper any exceptions to the conditions of the bid. This sheet will be labeled, "Exceptions to Bid Conditions", and will be attached to the bid. If no exceptions are stated, it will be understood that all general and specific conditions will be complied with, without exception.

The Bidder must specify in its Bid any alternatives it wishes to propose for consideration by the County. Each alternative should be sufficiently described and labeled within the Bid and should indicate its possible or actual advantage to the program being offered.

The County reserves the right to offer these alternatives to other Bidders.

**GENERAL PROVISIONS
SHERIFF DEPARTMENT UNIFORMS & SUPPLIES
GALVESTON COUNTY, TEXAS**

10. PRICING:

Bids will be either lump sum or unit prices as shown on the Bid sheet. The net priced items will be delivered to Galveston County, including all freight or shipping charges. Cash discount must be shown on bid, otherwise prices will be considered net. Unless prices and all information requested are complete, Bid may be disregarded and given no consideration. In case of default by the contractor, the County of Galveston may procure the articles or services from other sources and may deduct from any monies due, or that may thereafter become due to the contractor, the difference between the price named in the contract of purchase order and the actual cost thereof to the County of Galveston. Prices paid by the County of Galveston shall be considered the prevailing market price at the time such purchase is made. Periods of performance may be extended if the facts as to the cause of delay justify such extension in the opinion of the Purchasing Agent and the Commissioners' Court.

11. PROCUREMENT CARD PROGRAM:

The County of Galveston participates in a Procurement Card (P-Card) program that allows payments made to a vendor by credit card. This method normally results in substantially faster bill payments, sometimes within three (3) to five (5) days of the actual transaction date. All transaction fees from the card provider are to be paid by the successful contractor. If your company will accept payment via credit card (Visa, MasterCard), please notate this in your Bid submittal.

12. PASS THROUGH COST ADJUSTMENTS:

Except in instances of extreme extenuating circumstances Contractor prices shall remain firm throughout the Contract period and any renewals. Examples of extreme extenuating circumstances include such situations as a nationwide rail strike, oil shortage or oil embargo.

In extreme extenuating circumstances, Contractors may be allowed to temporarily "pass through" additional costs they are forced to incur through no fault of their own. A request for a pass through cost increase will not be considered unless a Contractor's cost for his product exceeds 10% over the original cost for the product. Also, the increase in cost must be nationwide and consistent for a minimum period of sixty (60) days. Costs that historically are anticipated to rise over a period of time (for example only, such as wages or insurance costs) do not qualify for pass through. If a Contractor thinks he will be asking for a pass through cost adjustment during the term of the contract, then the original cost of the product to Contractor must be stated in Contractor's original bid.

A request for a pass through cost does not guarantee that one will be granted. Contractors must submit such information on each request as is required by the County Purchasing Agent. The County Purchasing Agent will review each request on a case-by-case basis and determine the appropriateness of each request as well as amount and duration of increase. Contractors will not be permitted any additional compensation for mark-ups or profits based on the increase in price. Rather, such additional compensation will be limited to the actual increase in original cost to the Contractor as such increase is reflected by the original cost stated in the bid. But in no event will the amount of additional compensation exceed 25% increase in Contractor's original cost for his product as such cost is reflected in Contractor's original Bid or the duration exceed a period of sixty (60) days. In addition, should, during the period of the pass through, cost return to normal or decrease to below pre pass through prices, appropriate downward adjustments will be made. No more than one pass through adjustment will be permitted per year.

13. MODIFICATION OF BIDS:

A Bidder may modify a bid by letter at any time prior to the submission deadline for receipt of Bids. Modification requests must be received prior to the submission deadline. Modifications made before opening time must be initialed by Bidder guaranteeing authenticity. Bids may not be amended or altered after the official opening with the single exception that any product literature and/or supporting data required by the actual specifications, if any, will be accepted at any time prior to the Commissioners' Court considering of same.

**GENERAL PROVISIONS
SHERIFF DEPARTMENT UNIFORMS & SUPPLIES
GALVESTON COUNTY, TEXAS**

14. SIGNATURE OF BIDS:

Each Bid shall give the complete mailing address of the Bidder and be signed by an authorized representative by original signature with the authorized representative's name and legal title typed below the signature line. Each bid shall include the Bidder's Federal Employer Identification Number (FEIN). Failure to sign the Contract page(s) and bid response sheets may disqualify the bid from being considered by the County. The person signing on behalf of the Bidder expressly affirms that the person is duly authorized to tender the bid and to sign the bid sheets and contract under the terms and conditions of this Invitation to Bid and to bind the Bidder thereto and further understands that the signing of the contract shall be of no effect until it is properly placed on the Commissioners' Court agenda, approved in open Court, authorized to be executed by the County Judge, and fully executed by both parties.

15. AWARD OF BIDS – EVALUATION CRITERIA AND FACTORS:

The award will be made to the responsible Bidder whose bid is determined to be the best evaluated offer demonstrating the best ability to fulfill the requirements set forth in this Invitation to Bid. **The proposed cost to the County will be considered firm and cannot be altered after the submission deadline, unless the County invokes its right to request a best and final offer.**

Each Bidder, by submitting a bid, agrees that if their bid is accepted by the Commissioners' Court, such Bidder will furnish all items and services upon which prices have been tendered and upon the terms and conditions in this bid and contract.

The contractor shall commence work only after the transmittal of a fully executed contract and after receiving written notification to proceed from the County Purchasing Agent. The contractor will perform all services indicated in the bid in compliance with this contract.

Neither department heads nor elected officials are authorized to sign any binding contracts or agreements prior to being properly placed on the Commissioners' Court agenda and approved in open court. Department heads and other elected officials are not authorized to enter into any type of agreement or contract on behalf of Galveston County. Only the Commissioners' Court, acting as a body, may enter into a contract on behalf of the County. Additionally, department heads and other elected officials are not authorized to agree to any type of supplemental agreements or contracts for goods or services. Supplemental agreements are subject to review by the County Legal Department prior to being signed by the County's authorized representatives.

The County of Galveston reserves the right to accept bids on individual items listed, or group items, or on the bid as a whole; to reject any and all bids; to waive any informality in the bids; and to accept the bid that appears to be in the best interest of the County. The selection process may, however, include a request for additional information or an oral presentation to support the written bid.

In determining and evaluating the best bid, the pricing may not necessarily be controlling, but quality, equality, efficiency, utility, general terms, delivery, suitability of the service offered, and the reputation of the service in general use will also be considered with any other relevant items. The Commissioners' Court shall be the sole judge in the determination of these matters.

The County reserves the right to reject any or all Bids in whole or in part received by reason of this Invitation to Bid and may discontinue its efforts under this Invitation to Bid for any reason or no reason or solely for the County's convenience at any time prior to actual execution of the contract by the County.

A Bidder whose bid does not meet the mandatory requirements set forth in this Invitation to Bid will be considered non-compliant.

GENERAL PROVISIONS
SHERIFF DEPARTMENT UNIFORMS & SUPPLIES
GALVESTON COUNTY, TEXAS

The invitation to submit a bid which appears in the newspaper, or other authorized advertising mediums, these general provisions, the specifications which follow, the Bid sheets, and any addenda issued are all considered part of the Bid.

Each Bidder, by submitting a bid, agrees that if its bid is accepted by the Commissioners' Court, such Bidder will furnish all items and services upon the terms and conditions in this Invitation to Bid and the resultant contract.

Notice of contract award will be made within ninety (90) days of opening of Bids to the lowest responsive and responsible contractor, whose bid complies with all the requirements in the Invitation to Bid.

Contractor shall submit to the County, for approval, within ten (10) days from notice of contract award, all Certificates of Insurance evidencing the required coverage as described under Insurance in the schedule of the Invitation to Bid.

The contractor shall not commence work under these terms and conditions of the contract until all required and applicable Certificates of Insurance, Performance and Payment Bonds, and Irrevocable Letters of Credit have been approved by the County of Galveston and the Contractor has received notice to proceed in writing and an executed copy of the contract from the County Purchasing Agent.

16. DISPUTE AFTER AWARD/PROTEST:

Any actual or prospective Bidder who is allegedly aggrieved in connection with the solicitation of this Invitation to Bid or award of a contract resulting therefrom may protest. The protest shall be submitted in writing to the Purchasing Agent within seven (7) calendar days after such aggrieved person knows of or should have known of the facts giving rise thereto. If the protest is not resolved by mutual agreement, the Purchasing Agent will promptly issue a decision in writing to the protestant. If the protestant wishes to appeal the decision rendered by the Purchasing Agent, such appeal must be made to the Commissioners' Court through the Purchasing Agent. The decision of the Commissioners' Court will be final. The Commissioners' Court need not consider protests unless this procedure is followed.

17. PUBLIC INFORMATION ACT:

The parties agree that the County is a governmental body for purposes of the Public Information Act, codified as Chapter 552 of the Texas Government Code and as such is required to release information in accordance with the Public Information Act. Bidder agrees that it has **clearly and conspicuously** marked any information that it considers to be confidential, proprietary, and/or trade secret in its Bid. County agrees to provide notice to Bidder in accordance with the Public Information Act in the event the County receives a request for information under the Public Information Act for information that the Bidder has marked as confidential, proprietary, and/or trade secret.

18. BIDDER'S E-MAIL ADDRESSES:

Notwithstanding the foregoing Section 17, Bidder acknowledges and agrees that the confidentiality of any and all email addresses it uses or discloses in communicating with the County are open to the public in accordance with Section 552.137 of the Government Code and consents to the release of its email addresses.

19. RESULTANT CONTRACT:

Bidder shall correctly and fully execute the resultant contract first. Afterwards, the contract shall be set for consideration by the Commissioners' Court. If the Commissioners' Court authorizes the execution of the contract, the resultant contract shall become effective upon the Commissioners' Court execution of same. Contract documents shall consist of the contract, the general and special provisions, the drawings, bid package (including best and final offer(s) if such is utilized), any addenda issued, and any change orders issued during the work.

If applicable to the attached, Bidder must sign three (3) original contracts and return with their bid submittal.

Bidder should submit a proposed contract with its Bid or its sample material terms and conditions.

**GENERAL PROVISIONS
SHERIFF DEPARTMENT UNIFORMS & SUPPLIES
GALVESTON COUNTY, TEXAS**

20. CONTRACT TERM:

The term of the resultant contract will begin on the date of execution by the Commissioners' Court and will terminate on the date specified in the resultant contract unless terminated earlier as herein set forth.

21. TERMINATION FOR DEFAULT:

Failure of either party in the performance of any of the provisions of this contract shall constitute a breach of contract, in which case either party may require corrective action within ten (10) days from date of receipt of written notice citing the exact nature of such breach. Failure of the party being notified to take corrective action within the prescribed ten (10) days, or failure to provide written reply of why no breach has occurred, shall constitute a Default of Contract.

All notices relating to default by Bidder of the provisions of the contract shall be issued by County by its Legal Department, and all replies shall be made in writing to the County Legal Department. Notices issued by or issued to anyone other than the County Legal Department shall be null and void and shall be considered as not having been issued or received.

Galveston County reserves the right to enforce the performance of this contract in any manner prescribed by law in the event of breach or default of this contract, and may contract with another party, with or without solicitation of bids or further negotiations. At a minimum, Bidder shall be required to pay any difference in service or materials, should it become necessary to contract with another source, plus reasonable administrative costs and attorney fees.

In the event of Termination for Default, Galveston County, its agents or representatives shall not be liable for loss of any profits anticipated to be made by Bidder.

In addition to the remedies stated herein, the County has the right to pursue other remedies permitted by law or in equity.

No waiver by either party of any event of default under this agreement shall operate as a waiver of any subsequent default under the terms of this agreement.

County reserves the right to terminate this contract immediately in the event Bidder:

- A. Fails to meet delivery or completion schedules; and/or
- B. Fails to otherwise perform in accordance with the accepted Bid and the contract.

22. TERMINATION FOR CONVENIENCE:

County may terminate this contract upon at least thirty (30) calendar days prior written notice for its convenience or for any reason deemed by the County to serve the public interest. County may terminate this contract upon thirty (30) calendar days prior written notice for any reason resulting from any governmental law, order, ordinance, regulations, or court order. In no event shall County be liable for loss of any profits anticipated to be made hereunder by Bidder should this contract be terminated early.

23. FORCE MAJEURE:

If by reason of Force Majeure either Party shall be rendered unable, wholly or in part, to carry out its responsibilities under this contract by any occurrence by reason of Force Majeure, then the Party unable to carry out its responsibility shall give the other Party notice and full particulars of such Force Majeure in writing within a reasonable time after the occurrence of the event, and such notice shall suspend the Party's responsibility for the continuance of the Force Majeure claimed, but for no longer period.

Force Majeure means acts of God, floods, hurricanes, tropical storms, tornadoes, earthquakes, or other natural disasters, acts of a public enemy, acts of terrorism, sovereign conduct, riots, civil commotion, strikes or lockouts, and

**GENERAL PROVISIONS
SHERIFF DEPARTMENT UNIFORMS & SUPPLIES
GALVESTON COUNTY, TEXAS**

other causes that are not occasioned by either Party's conduct which by the exercise of due diligence the Party is unable to overcome and which substantially interferes with operations.

24. ESTIMATED QUANTITIES:

Any reference to quantities shown in the Invitation to Bid is an estimate only. Since the exact quantities cannot be predetermined, the County reserves the right to adjust quantities as deemed necessary to meet its requirements.

25. CONTRACTOR INVESTIGATION:

Before submitting a bid, each Bidder shall make all investigations and examinations necessary to ascertain all site conditions and requirements affecting the full performance of the contract and to verify any representations made by the County upon which the contractor will rely. If the contractor receives an award as a result of its bid submission, failure to have made such investigations and examinations will in no way relieve the contractor from its obligation to comply in every detail with all provisions and requirements of the contract, nor will a plea of ignorance of such conditions and requirements be accepted as a basis for any claim whatsoever by the contractor for additional compensation.

26. NO COMMITMENT BY COUNTY OF GALVESTON:

This Invitation to Bid does not commit the County of Galveston to award any costs or pay any costs, or to award any contract, or to pay any costs associated with or incurred in the preparation of a bid in response to this Invitation to Bid and does not commit the County of Galveston to procure or contract for services or supplies.

27. BID COSTS BORNE BY BIDDER:

Galveston County shall not be liable for any costs incurred by Bidder in preparation, production, or submission of a bid and shall not be liable for any work performed by Bidder prior to issuance of fully executed contract and properly issued notice to proceed. Galveston County shall not be liable for any costs incurred by Bidder by reason of attending a pre-Bid conference. Galveston County shall not be liable for any costs incurred by Bidder by reason of the County invoking use of best and final offers.

28. BEST AND FINAL OFFERS (BAFO):

In acceptance of bids, the County of Galveston reserves the right to negotiate further with one or more of the Bidders as to any features of their bids and to accept modifications of the work and price when such action will be in the best interest of the County. This includes solicitation of a Best and Final Offer from one or more of the Bidders. If invoked, this allows acceptable Bidders the opportunity to amend, change or supplement their original bid. Bidders may be contacted in writing requesting that they submit their Best and Final Offer. Any such Best and Final Offer must include discussed and negotiated changes.

29. SINGLE BID RESPONSE:

If only one bid is received in response to the Invitation to Bid, a detailed cost bid may be requested of the single contractor. A cost/price analysis and evaluation and/or audit may be performed of the cost bid in order to determine if the price is fair and reasonable.

30. CHANGES IN SPECIFICATIONS:

If it becomes necessary to revise any part of this bid, a written notice of such revision will be provided to all Bidders in the form of addenda. The County is not bound by any oral representations, clarifications, or changes made in the written specifications by the County's employees, unless such clarification or change is provided to Bidders in a written addendum from the Purchasing Agent.

The County of Galveston reserves the right to revise or amend the specifications up to the time set for opening of bids. Such revisions and amendments, if any, shall be announced by amendments to the solicitation. Copies of such

**GENERAL PROVISIONS
SHERIFF DEPARTMENT UNIFORMS & SUPPLIES
GALVESTON COUNTY, TEXAS**

amendments shall be furnished to all prospective contractors. Prospective contractors are defined as those contractors listed on the County's Invitation to Bid list for this material/service or those who have obtained documents subsequent to the advertisement. If revisions and amendments require changes in quantities or prices proposed, or both, the date set for opening of bids may be postponed by such number of days as in the opinion of the County shall enable contractors to revise their bids. In any case, the bid opening shall be at least five working days after the last amendment, and the amendment shall include an announcement of the new date if applicable, for the opening or bids.

31. BID IDEAS AND CONCEPTS:

The County reserves to itself the right to adopt or use for its benefit, any concept, plan, or idea contained in any bid.

32. BID DISCLOSURES:

The names of those who submitted bids will not be made public information unless in conformity with the County Purchasing Act. No pricing or staffing information will be released. Bidders are requested to withhold all inquiries regarding their bid or other submissions until after an award is made. No communication is to be had with any County employee or official, other than the County Purchasing Agent, regarding whether a bid was received. Violations of this provision may result in the rejection of a bid.

33. WITHDRAWAL OF BID:

Bidders may request withdrawal of a sealed bid prior to the scheduled bid opening time provided the request for withdrawal is submitted to the Purchasing Agent in writing. No bids may be withdrawn for a period of sixty (60) calendar days after opening of the bids.

34. INDEMNIFICATION:

The contractor shall agree to assume all risks and responsibility for, and agrees to indemnify, defend, and save harmless, the County of Galveston, its elected and appointed officials and department heads, and its agents and employees from and against all claims, demands, suits, actions, recoveries, judgments, and costs and expenses including reasonable attorney's fees for the defense thereof in connection therewith on account of the loss of life, property or injury or damage to the person which shall arise from contractor's operations under this contract, its use of County facilities and/or equipment or from any other breach on the part of the contractor, its employees, agents or any person(s), in or about the County's facilities with the expressed or implied consent of the County. Contractor shall pay any judgment with cost which may be obtained against Galveston County resulting from contractor's operations under this contract.

Contractor agrees to indemnify and hold the County harmless from all claims of subcontractors, laborers incurred in the performance of this contract. Contractor shall furnish satisfactory evidence that all obligations of this nature herein above designated have been paid, discharged or waived. If Contractor fails to do so, then the County reserves the right to pay unpaid bills of which County has written notice direct and withhold from Contractor's unpaid compensation a sum of money reasonably sufficient to liquidate any and all such lawful claims.

35. REQUIREMENT OF AND PROOF OF INSURANCE:

The successful Bidder shall furnish evidence of insurance to the County Purchasing Agent and shall maintain such insurance as required hereunder or as may be required in the Special Provisions or resultant contract, if different. Contractor shall obtain and thereafter continuously maintain in full force and effect, commercial general liability insurance, including but not limited to bodily injury, property damage, and contractual liability, with combined single limits as listed below or as may be required by State or Federal law, whichever is greater.

A. For damages arising out of bodily injury to or death of one person in any one accident :
ONE HUNDRED THOUSAND AND NO/100 (\$100,000.00) DOLLARS.

B. For damages arising out of bodily injury to or death of two or more persons in any one accident:
THREE HUNDRED THOUSAND AND NO/100 (\$300,000.00) DOLLARS.

**GENERAL PROVISIONS
SHERIFF DEPARTMENT UNIFORMS & SUPPLIES
GALVESTON COUNTY, TEXAS**

- C. For any injury to or destruction of property in any one accident :
ONE HUNDRED THOUSAND AND NO/100 (\$100,000.00) DOLLARS.

Insurance shall be placed with insurers having an A.M. Best's rating of no less than A. Such insurance must be issued by a casualty company authorized to do business in the State of Texas, and in standard form approved by the Board of Insurance Commissioners of the State of Texas, with coverage provisions insuring the public from loss or damage that may arise to any person or property by reason of services rendered by Contractor.

Galveston County shall be listed as the additional insured on policy certificates and shall be provided with no less than thirty (30) calendar days prior notice of any changes to the policy during the contractual period.

Certificates of Insurance, fully executed by a licensed representative of the insurance company written or countersigned by an authorized Texas state agency, shall be filed with the County Purchasing Agent within ten (10) business days of issuance of notification from the County Purchasing Agent to Bidder that the contract is being activated as written proof of such insurance and further provided that Bidder shall not commence work under this contract until it has obtained all insurance required herein, provided written proof as required herein, and received written notice to proceed issued from the County Purchasing Agent.

Proof of renewal/replacement coverage shall be provided upon expiration, termination, or cancellation of any policy. Said insurance shall not be cancelled, permitted to expire, or changed without thirty (30) days prior written notice to the County.

Insurance required herein shall be maintained in full force and effect during the life of this contract and shall be issued on an occurrence basis. Contractor shall require that any and all subcontractors that are not protected under the Contractor's own insurance policies take and maintain insurance of the same nature and in the same amounts as required of Contractor and provide written proof of such insurance to Contractor. Proof of renewed/replacement coverage shall be provided upon expiration, termination, or cancellation of any policy. Contractor shall not allow any subcontractor to commence work on the subcontract until such insurance required for the subcontractor has been obtained and approved.

Workers' Compensation Insurance: Successful Bidder shall carry in full force Workers' Compensation Insurance Policy(ies), if there is more than one employee, for all employees, including but not limited to full time, part time, and emergency employees employed by the successful Bidder. Current insurance certificates certifying that such policies as specified above are in full force and effect shall be furnished by successful Bidder to the County.

Insurance is to be placed with insurers having a Best rating of no less than A. The Bidder shall furnish the County with certificates of insurance and original endorsements affecting coverage required by these insurance clauses within ten (10) business days of receiving notification from the County Purchasing Agent that the contract is being activated. The certificates and endorsements for each insurance policy are to be signed by a person authorized by the insurer to bind coverage on its behalf. The Bidder shall be required to submit annual renewals for the term of this contract prior to expiration of any policy.

In addition to the remedies stated herein, the County has the right to pursue other remedies permitted by law or in equity.

The County agrees to provide Bidder with reasonable and timely notice of any claim, demand, or cause of action made or brought against the County arising out of or related to utilization of the property. Bidder shall have the

GENERAL PROVISIONS
SHERIFF DEPARTMENT UNIFORMS & SUPPLIES
GALVESTON COUNTY, TEXAS

right to defend any such claim, demand, or cause of action at its sole cost and expense and within its sole and exclusive discretion. The County agrees not to compromise or settle any claim or cause of action arising out of or related to the utilization of the property without the prior written consent of the Bidder.

In no event shall the County be liable for any damage to or destruction of any property belonging to the Bidder.

36. PATENT AND COPYRIGHT PROTECTION:

The Bidder agrees at its sole expense to protect the County from claims involving infringement of patents or copyrights. **Bidder shall indemnify and save harmless the County of Galveston, its officers, employees, and agents, from liability of any nature and kind whatsoever, including without limitation cost and expenses, for or on account of any copyrighted, patented or un-patented invention, process, or article manufactured or used in the performance of the contract, including its use by the County.** Bidder also agrees that if Bidder is awarded this contract, that no work performed hereunder shall be subject to patent, copyright, or other intellectual property by Bidder.

37. CONFLICT OF INTEREST DISCLOSURE REPORTING:

Bidder may be required under Chapter 176 of the Texas Local Government Code to complete and file a conflict of interest questionnaire (CIQ Form). If so, the completed CIQ Form must be filed with the County Clerk of Galveston County, Texas.

If Bidder has an employment or other business relationship with an officer of Galveston County or with a family member of an officer of Galveston County that results in the officer or family member of the officer receiving taxable income that exceeds \$2,500.00 during the preceding 12-month period, then Bidder **MUST** complete a CIQ Form and file the original of the CIQ Form with the County Clerk of Galveston County.

If Bidder has given an officer of Galveston County or a family member of an officer of Galveston County one or more gifts with an aggregate value of more than \$250.00 during the preceding 12-months, then Bidder **MUST** complete a CIQ Form and file the original of the CIQ Form with the County Clerk of Galveston County.

The Galveston County Clerk has offices at the following locations:

Galveston County Clerk
Galveston County Justice Center, Suite 2001
600 59th Street
Galveston, Texas 77551

Galveston County Clerk
North County Annex, 1st Floor
174 Calder Road
League City, Texas 77573

Again, if Bidder is required to file a CIQ Form, the original completed form is filed with the Galveston County Clerk (not the Purchasing Agent).

For Bidder's convenience, a blank CIQ Form is enclosed with this bid package. Blank CIQ Forms may also be obtained by visiting the Galveston County Clerk's website and/or the Purchasing Agent's website – both of these websites are linked from the Galveston County homepage, at <http://www.co.galveston.tx.us>.

As well, blank CIQ Forms may be obtained by visiting the Texas Ethics Commission website, specifically at http://www.ethics.state.tx.us/whatsnew/conflict_forms.htm.

Chapter 176 specifies deadlines for the filing of CIQ Forms (both initial filings and updated filings).

**GENERAL PROVISIONS
SHERIFF DEPARTMENT UNIFORMS & SUPPLIES
GALVESTON COUNTY, TEXAS**

It is Bidder's sole responsibility to file a true and complete CIQ Form with the Galveston County Clerk if Bidder is required to file by the requirements of Chapter 176 of the Local Government Code. Bidder is advised that it is an offense to fail to comply with the disclosure reporting requirements dictated under Chapter 176 of the Texas Local Government Code.

If you have questions about compliance with Chapter 176, please consult your own legal counsel. Compliance is the individual responsibility of each person, business, and agent who is subject to Chapter 176 of the Texas Local Government Code.

38. COMPETITIVENESS AND INTEGRITY:

To prevent biased evaluations and to preserve the competitiveness and integrity of such acquisition efforts, **Bidders are to direct all communications regarding this Bid to the Galveston County Purchasing Agent**, unless otherwise specifically noted.

Do not contact the requesting department. Attempts by offering firms to circumvent this requirement will be viewed negatively and may result in rejection of the offer of the firm found to be in non-compliance.

All questions regarding this Request for Bid must be submitted in writing to:

**Rufus Crowder, CPPO CPPB
Galveston County Purchasing Agent
722 Moody, (21st Street)
Fifth (5th) Floor, Purchasing
Galveston, Texas 77550 Fax: (409) 621-7997
E-mail: rufus.crowder@co.galveston.tx.us**

An authorized person from the submitting firm must sign all bids. This signature acknowledges that the Bidder has read the bid documents thoroughly before submitting a bid and will fulfill the obligations in accordance to the terms, conditions, and specifications.

Please carefully review this Invitation to Bid. It provides specific information necessary to aid participating firms in formulating a thorough response.

39. ENTIRETY OF AGREEMENT AND MODIFICATION:

This contract contains the entire agreement between the parties. Any prior agreement, promise, negotiation or representation not expressly set forth in this contract has no force or effect. Any subsequent modification to this contract must be in writing, signed by both parties. An official representative, employee, or agent of the County does not have the authority to modify or amend this contract except pursuant to specific authority to do so granted by the Galveston County Commissioners' Court.

40. NON-COLLUSION AFFIDAVIT:

Bidder certifies, by signing and submitting a bid, that the bid is not made in the interest of, or on behalf of, any undisclosed person, partnership, company, association, organization, or corporation; that the bid is genuine and not collusive or sham; that the contractor has not directly or indirectly induced or solicited another contractor to put in a false or sham bid, and has not directly or indirectly colluded, conspired, connived, or agreed with any contractor or anyone else to put in a sham Bid or that anyone shall refrain from bidding; that the contractor has not in any manner, directly or indirectly, sought by agreement, communications, or conference with anyone to fix the bid price of the contractor of any other bidder, or to fix any overhead, profit or cost element of the bid price, or that of any other contractor, or to secure any advantage against the public body awarding the contract or anyone interested in the

GENERAL PROVISIONS
SHERIFF DEPARTMENT UNIFORMS & SUPPLIES
GALVESTON COUNTY, TEXAS

proposed contract; that all statements contained in the bid are true; and further, that the contractor has not, directly or indirectly, submitted his or her bid price or any breakdown thereof, or the contents thereof, or divulged information or data relative thereto, or paid, and will not pay, any fee to any cooperation, partnership, company association, organization, Bid depository, or to any member or agent thereof to effectuate a collusive or sham bid.

A blank Non-Collusion Affidavit is included with this Bid packet. Bidder must enclose a truthful and fully executed original Non-Collusion Affidavit with the submission of its bid. This is a mandatory requirement of this Invitation to Bid. Failure to include the truthfully and fully executed Non-Collusion Affidavit in the submission of its Bid shall be considered non-compliance with the requirements of this Invitation to Bid by the Bidder and grounds for the rejection of Bidder's submission.

No negotiations, decisions, or actions shall be initiated by any company as a result of any verbal discussion with any County employee prior to the opening of responses to this Invitation to Bid.

No officer or employee of the County of Galveston, and no other public or elected official, or employee, who may exercise any function or responsibilities in the review or approval of this undertaking shall have any personal or financial interest, direct or indirect, in any contract or negotiation process thereof. The above compliance request will be part of all County of Galveston contracts for this service.

41. SOVEREIGN IMMUNITY:

The County specifically reserves any claim it may have to sovereign, qualified, or official immunity as a defense to any action arising in conjunction with this contract.

42. CONTROLLING LAW AND VENUE:

Bidder acknowledges and agrees that the contract is and shall be governed and construed by the laws of the State of Texas and that venue shall lie exclusively in Galveston County, Texas.

43. MERGERS, ACQUISITIONS:

The Bidder shall be required to notify the County of any potential for merger or acquisition of which there is knowledge at the time that a bid is submitted.

If subsequent to the award of any contract resulting from this Invitation to Bid the Bidder shall merge or be acquired by another firm, the following documents must be submitted to the County:

- A. Corporate resolutions prepared by the awarded Bidder and the new entity ratifying acceptance of the original contract, terms, conditions and prices;
- B. New Bidder's Federal Identification Number (FEIN) and;
- C. New Bidder's proposed operating plans.

Moreover, Bidder is required to provide the County with notice of any anticipated merger or acquisition as soon as Bidder has actual knowledge of the anticipated merger or acquisition. The New Bidder's proposed plan of operation must be submitted prior to merger to allow time for submission of such plan to the Commissioners' Court for its approval.

44. DELAYS:

The County reserves the right to delay the scheduled commencement date of the contract if it is to the advantage of the County. There shall be no additional costs attributed to these delays should any occur. Bidder agrees it will make no claims for damages, for damages for lost revenues, for damages caused by breach of contract with third parties, or any other claim by Bidder attributed to these delays, should any occur. In addition, Bidder agrees that any contract it enters into with any third party in anticipation of the commencement of the contract will contain a statement that the third party will similarly make no claim for damages based on delay of the scheduled commencement date of the contract.

**GENERAL PROVISIONS
SHERIFF DEPARTMENT UNIFORMS & SUPPLIES
GALVESTON COUNTY, TEXAS**

45. ACCURACY OF DATA:

Information and data provided through this Invitation to Bid are believed to be reasonably accurate.

46. SUBCONTRACTING/ASSIGNMENT:

Bidder shall not assign, sell, or otherwise transfer its contract in whole or in part without prior written permission of Commissioners' Court. Such consent, if granted, shall not relieve the Bidder of any of its responsibilities under this contract.

47. INDEPENDENT CONTRACTOR:

Bidder expressly acknowledges that it is an independent contractor. Nothing in this agreement is intended nor shall be construed to create an agency relationship, an employer/employee relationship, a joint venture relationship, or any other relationship allowing County to exercise control or direction over the manner or method by which Bidder or its subcontractors perform in providing the requirements stated in the Invitation to Bid.

48. MONITORING PERFORMANCE:

The County shall have the unfettered right to monitor and audit the Bidder's work in every respect. In this regard, the Bidder shall provide its full cooperation and insure the cooperation of its employees, agents, assigns, and subcontractors. Further, the Bidder shall make available for inspection and/or copying when requested, original data, records, and accounts relating to the Bidder's work and performance under this contract. In the event any such material is not held by the Bidder in its original form, a true copy shall be provided.

49. PROCUREMENT ETHICS:

Galveston County is committed to the highest ethical standards. Therefore, it is a serious breach of the public trust to subvert the public purchasing process by directing purchases to certain favored vendors, or to tamper with the competitive bidding process, whether it's done for kickbacks, friendship or any other reason. Since misuse of the purchasing power of a local government carries criminal penalties, and many such misuses are from a lack of clear guidelines about what constitutes an abuse of office, the Code of Ethics outlined below must be strictly followed.

Galveston County also requires ethical conduct from those who do business with the County.

CODE OF ETHICS – Statement of Purchasing Policy:

“Public employment is a public trust. It is the policy of Galveston County to promote and balance the objective of protecting the County's integrity and the objective of facilitating the recruitment and retention of personnel needed by Galveston County. Such policy is implemented by prescribing essential standards of ethical conduct without creating unnecessary obstacles to entering public office.

Public employees must discharge their duties impartially so as to assure fair competitive access to governmental procurement by responsible contractors. Moreover, they should conduct themselves in such a manner as to foster public confidence in the integrity of the Galveston County procurement organization.

To achieve the purpose of this Article, it is essential that those doing business with Galveston County also observe the ethical standards prescribed here.”

General Ethical Standards:

It shall be a breach of ethics to attempt to realize personal gain through public employment with Galveston County by any conduct inconsistent with the proper discharge of the employee's duties.

It shall be a breach of ethics to attempt to influence any public employee of Galveston County to breach the standards of ethical conduct set forth in this code.

GENERAL PROVISIONS
SHERIFF DEPARTMENT UNIFORMS & SUPPLIES
GALVESTON COUNTY, TEXAS

It shall be a breach of ethics for any employee of Galveston County to participate directly or indirectly in a procurement when the employee knows that:

The employee or any member of the employee's immediate family, has a financial interest pertaining to the procurement;

A business or organization in which the employee or any member of the employee's immediate family, has a financial interest pertaining to the procurement; or

Any other person, business, or organization with which the employee or any member of the employee's immediate family is negotiating or has an arrangement concerning prospective employment is involved in the procurement.

Gratuities:

It shall be a breach of ethics for any person to offer, give, or agree to give any employee or former employee of Galveston County, or for any employee or former employee of Galveston County to solicit, demand, accept or agree to accept from another person, a gratuity or an offer of employment in connection with any decision, approval, disapproval, recommendation, preparation of any part of a program requirement or a purchase request, influencing the content of any specification or procurement standard, rendering of advice, investigation, auditing, or in any other advisory capacity in any proceeding or application, request for ruling, determination, claim or controversy, or other particular matter, pertaining to any program requirement or a contract or subcontract, or to any solicitation or bid thereof.

Kickbacks:

It shall be a breach of ethics for any payment, gratuity or offer of employment to be made by or on behalf of a subcontractor under a contract to the prime contractor or higher tier subcontractor or to any person associated therewith as an inducement for the award of a subcontract or order.

Contract Clause:

The prohibition against gratuities and kickbacks prescribed above shall be conspicuously set forth in every contract and solicitation by Galveston County.

Confidential Information:

It shall be a breach of ethics for any employee or former employee of Galveston County to knowingly use confidential information for actual or anticipated personal gain, or for the actual or anticipated gain of any other person.

Prohibition against Contingent Fees:

It shall be a breach of ethical standards for a person to be retained, or to retain a person, to solicit or secure a Galveston County contract upon an agreement or understanding for a commission, percentage, brokerage, or contingent fee, except for retention of bona fide employees or bona fide established commercial selling agencies for the purpose of securing business. Failure to abide by this section constitutes a breach of ethical standards.

Representation:

Bidder represents and warrants, by signing and submitting its bid, that it has not retained anyone in violation of this section prohibiting contingent fees.

Contract Clause:

The representation prescribed above shall be conspicuously set forth in every contract and solicitation thereof.

50. SUBJECT TO APPROPRIATION OF FUNDS:

State law prohibits the obligation and expenditure of public funds beyond the fiscal year for which a budget has been approved by the Commissioners' Court. Galveston County anticipates this to be an integral part of future budgets to be

**GENERAL PROVISIONS
SHERIFF DEPARTMENT UNIFORMS & SUPPLIES
GALVESTON COUNTY, TEXAS**

approved during the periods of this contract, except for unanticipated needs or events which may prevent such payments against this contract. However, Galveston County cannot guarantee the availability of funds, and enters into this contract only to the extent such funds are made available through appropriation (allocation) by the Commissioners' Court. This contract shall not be construed as creating any debt on behalf of the County of Galveston in violation of TEX. CONST. art. XI, § 7, and it is understood that all obligations of Galveston County are subject to the availability of funds.

51. NOTICE:

All notices or other communications required or permitted under this contract shall be in writing and shall be deemed to have been duly given if delivered personally in hand, transmitted by facsimile, or mailed certified mail, return receipt requested with proper postage affixed and addressed to the appropriate party at the following address or at such other address as may have been previously given in writing to the parties (Bidder shall provide its notice information with its Bid submission). If mailed, the notice shall be deemed delivered when actually received, or if earlier, on the third day following deposit in a United States Postal Service post office or receptacle, duly certified, return receipt requested, with proper postage affixed. If delivered in person, notice shall be deemed delivered when received for by, or actually received by, the receiving Party.

If transmitted by facsimile, notice shall be deemed delivered when receipt of such transmission is acknowledged.

To the County at:

Hon. Mark Henry,
County Judge of Galveston County
722 Moody (21st Street), Second (2nd) Floor
Galveston, Texas 77550
Fax: (409) 765-2653

With copies to:

Rufus Crowder, CPPO CPPB,
Galveston County Purchasing Agent
722 Moody (21st Street), Fifth (5th) Floor
Galveston, Texas 77550
Fax: (409) 621-7997

Robert Boemer, Director,
Galveston County Legal Department
722 Moody (21st Street), Fifth (5th) Floor
Galveston, Texas 77550
Fax: (409) 770-5560

To the Contractor at:

(Bidder to provide its contact name, address, and facsimile number for notice hereunder.)

52. NON-DISCRIMINATION:

- A. **Equal Employment Opportunity:** Bidder will not discriminate against any employee or applicant for employment because of race, color, religion, national origin, sex, disability, genetic information or veteran status. Bidder will take affirmative action to ensure that applicants are employed, and that employees are treated during employment, without regard to their race, color, religion, national origin, sex, disability, genetic information or veteran status. Such action shall include, but not be limited to, the following: employment; upgrading; demotion or transfer; recruitment or recruitment advertising; layoff or termination; rates of pay or other forms of compensation; and selection for training, including apprenticeship. Bidder agrees to post in conspicuous places, available to employees and applicants for employment, notices of employment.

GENERAL PROVISIONS
SHERIFF DEPARTMENT UNIFORMS & SUPPLIES
GALVESTON COUNTY, TEXAS

Bidder will, in all solicitation or advertisements for employees placed by or on behalf of Bidder, state that all qualified applicants will receive consideration for employment without regard to race, color, religion, national origin, sex, disability, genetic information, or veteran status.

Bidder will cause the foregoing provisions to be inserted in all subcontracts for any work covered by this Agreement so that such provisions will be binding upon each subcontractor, provided that the foregoing provisions shall not apply to contracts or subcontracts for standard commercial supplies or raw materials.

Bidder will include the provisions herein in every subcontract or purchase order unless exempted.

- B. **Drug Free Work Place Act:** Bidder shall comply with all applicable requirements of the Drug-Free Workplace Act of 1988 and implementing regulations.
- C. **Americans with Disabilities Act:** Bidder shall comply with all applicable provisions of the Americans with Disabilities Act and implementing regulations.
- D. **OSHA Regulations:** Bidder agrees to maintain and to display any applicable materials for its employees in accordance with OSHA regulations.
- E. **Compliance with Immigration Laws and Use of E-Verify:** Bidder agrees to comply with all requirements of the U.S. Immigration Reform and Control Act of 1986, as amended, and any implementing regulations thereto. Bidder further agrees to utilize the E-Verify system through the Department of Homeland Security on its employees. Bidder shall not employ unauthorized aliens, and shall not assign services to be performed to any supplier or subcontractor who are unauthorized aliens. If any personnel performing any services hereunder are discovered to be an unauthorized alien, then Bidder will immediately remove such personnel from performing services hereunder and shall replace such personnel with personnel who are not unauthorized alien(s).
- F. **State and Federal Law Compliance:** Bidder agrees to comply with all other State and Federal laws and regulations applicable to the provision of services under this contract.

53. RECORD RETENTION AND RIGHT TO AUDIT:

Bidder shall keep and maintain all records associated with this contract for a minimum of five (5) years from the close of the contract or as required by Federal or State law or regulation, whichever period is longer. If awarded this contract, Bidder shall allow the County reasonable access to the records in Bidder's possession, custody, or control that the County deems necessary to assist it in auditing the services, costs, and payments provided hereunder. If this contract involves the use of Federal or State funds, then Bidder shall also allow reasonable access to representatives of the Office of Inspector General, the General Accounting Office, and the other Federal and/or State agencies overseeing the funds that such entities deem necessary to facilitate review by such agencies and Bidder shall maintain fiscal records and supporting documentation for all expenditures in a manner that conforms with OMB Circular A-87 (relocated to 2 C.F.R. Part 225) and this contract.

54. TITLE VI ASSURANCES/TxDOT:

The County is subject to Title VI of the Civil Rights Act of 1964 and the Federal and State laws and regulations of the United States Department of Transportation and Texas Department of Transportation (TxDOT). Pursuant to these requirements, the County must have its contractors provide required assurances on compliance with non-discrimination by itself and its subcontractors. The Title VI Assurances within this Subsection are not exhaustive – whenever any Federal, State, or Local requirement requires additional clauses, this list shall not be construed as limiting. Contractor agrees as follows:

- A. **Compliance with Regulations:** The Contractor shall comply with the Regulations relative to nondiscrimination in Federally-assisted programs of the Department of Transportation (hereinafter, DOT)

GENERAL PROVISIONS
SHERIFF DEPARTMENT UNIFORMS & SUPPLIES
GALVESTON COUNTY, TEXAS

Title 49, Code of Federal Regulations, Part 21, as they may be amended from time to time (hereinafter referred to as the Regulations), which are incorporated herein by reference and made a part of this contract.

- B. **Non-discrimination:** The Contractor, with regard to the work performed by it during the contract, shall not discriminate on the basis of race, color, national origin, religion, sex, age, disability or Veteran status in the selection and retention of subcontractors, including procurements of materials and leases of equipment. The Contractor shall not participate either directly or indirectly in the discrimination prohibited by Section 21.5 of the Regulations, including employment practices when the contract covers a program set forth in Appendix B of the Regulations.
- C. **Solicitations for Subcontractors, Including Procurement of Materials and Equipment:** In all solicitations either by competitive bidding or negotiation made by the Contractor for work to be performed under a subcontract, including procurement of materials or leases of equipment, each potential subcontractor or supplier shall be notified by the Contractor of the Contractor's obligations under this contract and the Regulations relative to nondiscrimination on the grounds of race, color, national origin, religion, sex, age, disability or Veteran status.
- D. **Information and Reports:** The Contractor shall provide all information and reports required by the Regulations or directives issued pursuant thereto, and shall permit access to its books, records, accounts, other sources of information and its facilities as may be determined by the Galveston County or the Texas Department of Transportation to be pertinent to ascertain compliance with such Regulations, orders and instructions. Where any information required of the Contractor is in the exclusive possession of another who fails or refuses to furnish this information the Contractor shall so certify to Galveston County or the Texas Department of Transportation as appropriate, and shall set forth what efforts it has made to obtain the information.
- E. **Sanctions for Non-compliance:** In the event of the Contractor's noncompliance with the nondiscrimination provisions of this contract, Galveston County shall impose such contract sanctions as it or the Texas Department of Transportation may determine to be appropriate, including, but not limited to:
- 1) withholding of payments to the Contractor under the contract until the Contractor complies, and/or;
 - 2) cancellation, termination, or suspension of the contract, in whole or in part.
- F. **Incorporation of Provisions.** The Contractor shall include the provisions of paragraphs (1) through (6) in every subcontract, including procurement of materials and leases of equipment, unless exempt by the Regulations, or directives issued pursuant thereto. The Contractor shall take such action with respect to any subcontract or procurement as Galveston County or the Texas Department of Transportation may direct as a means of enforcing such provisions including sanctions for non-compliance: Provided, however, that, in the event Contractor becomes involved in, or is threatened with, litigation with a subcontractor or supplier as a result of such direction, the Contractor may request Galveston County to enter into such litigation to protect the interests of Galveston County, and, in addition, the Contractor may request the United States to enter into such litigation to protect the interests of the United States.

55. CERTIFICATION REGARDING DEBARMENT, SUSPENSION, PROPOSED DEBARMENT, AND OTHER RESPONSIBILITY MATTERS:

Bidder certifies that neither it, nor any of its Principals, are presently debarred, suspended, proposed for debarment, disqualified, excluded, or in any way declared ineligible for the award of contracts by any Federal agency. Contractor agrees that it shall refund Galveston County for any payments made to Contractor while ineligible. Contractor acknowledges that Contractor's uncured failure to perform under this Agreement, if such should occur, may result in Contractor being debarred from performing additional work for the County, the GLO, the State, HUD, and other

Federal and State entities. Further, Bidder has executed the Certification Regarding Debarment, Suspension, Proposed Debarment, and Other Responsibility Matters and returned the fully completed and executed original

**GENERAL PROVISIONS
SHERIFF DEPARTMENT UNIFORMS & SUPPLIES
GALVESTON COUNTY, TEXAS**

certification with the submission of its bid. **The truthful and fully completed and executed original of the Certification Regarding Debarment, Suspension, Proposed Debarment, and Other Responsibility Matters must be included with the submission of Bidder's Bid and is a mandatory requirement of this Invitation to Bid. Bidder's failure to include the fully completed and executed original of this Certification shall be considered non-compliance with the requirements of this Invitation to Bid and grounds for the rejection of Bidder's Bid.**

56. SECTION 231.006, FAMILY CODE/DELINQUENT CHILD SUPPORT:

Pursuant to Title 5, Section 231.006 of the Texas Family Code, as applicable, Bidder certifies that it, including all of its principals, is/are current in child support payments and therefore, that it is eligible to receive payments from State funds under a contract for property, materials, or services. Bidder acknowledges and agrees that if it is awarded this contract, then the ensuing agreement may be terminated and payment withheld if this certification is inaccurate. Finally, by the submission of its bid, the Bidder certifies that it has included the names and social security numbers of each person with at least 25% ownership interest in Bidder within its response to the Invitation to Bid and that all such persons are current in child support payments.

57. LABOR STANDARDS:

If applicable to this solicitation, Bidder acknowledges that the contract to be awarded pursuant to this solicitation is on a grant program funded with Federal funds.

Bidder shall comply with the requirements of 29 CFR Part 5 and CFR Part 30 and shall be in conformity with Executive Order 11246, entitled "Equal Employment Opportunity", Copeland, "Anti-Kickback" Act (29 C.F.R. Part 3), the Davis-Bacon and Related Acts (29 C.F.R. Parts 1,3, and 5), the Contract Work Hours and Safety Standards Act (40 U.S.C. 3701 et seq.), and all other applicable Federal, State, and local laws and regulations pertaining to labor standards, insofar as those acts apply to the performance of this Agreement. Bidder is also responsible for ensuring that all subcontractors comply with the requirements of 29 CFR Part 5 and CFR Part 30 and shall be in conformity with Executive Order 11246, entitled "Equal Employment Opportunity", Copeland "Anti-Kickback" Act, the Davis-Bacon and Related Acts (29 CFR Parts 1, 3 and 5), the Contract Work Hours and Safety Standards Act (40 U.S.C. 3701 et seq.), and all other applicable Federal, State, and local laws and regulations pertaining to labor standards, insofar as those acts apply to the performance of this Agreement.

End of General Provision Section

The remainder of this page intentionally left blank

**SPECIAL PROVISIONS
SHERIFF DEPARTMENT UNIFORMS & SUPPLIES
GALVESTON COUNTY, TEXAS**

The Special Provisions section of this Invitation to Bid solicitation and the exhibits attached herein are made a part of the entire agreement between the parties with respect to the subject matter of the Invitation to Bid and Resultant Contract Agreement, and supersede the General Provisions, any prior negotiations, agreements, and understanding with respect thereto.

PURPOSE

Galveston County is seeking a vendor to supply uniforms and supplies for the Galveston County Sheriff's Office.

BID GUARANTEE:

A bid bond is not a requirement of this solicitation request.

PERFORMANCE AND PAYMENT BONDS:

Performance and Payment bonds are not a requirement of this solicitation.

BEST AND FINAL OFFERS (BAFO):

The Best and Final Offer process is not applicable to this solicitation.

AWARD OF BID:

Awards will be based on the total sum price. In the case of errors in extensions, the unit price will prevail.

ANY REFERENCES TO NAME BRANDS ARE FOR BIDDING PURPOSES ONLY and are only meant to describe the type of uniform and supplies described by the County. Supplied clothing and supplies must meet or exceed the specifications listed below to be considered for award.

No taxes are to be added as Galveston County is exempt by Statute.

If bidder does not wish to bid at this time but wishes to remain on the bid list for this commodity, please submit a "NO BID" by the same time and at same location as stated for bidding.

TERM OF CONTRACT:

The contract awarded under these specifications will be for one (1) year period with a renewal for two (2) years in one (1) year increments, exercisable at the sole discretion of the County. Galveston County shall provide written notice of its intent to exercise its renewal option at least thirty (30) days prior to the anniversary date of the contract.

COST ADJUSTMENT:

Prices quoted shall be firm for the initial contract term and all approved extensions periods. No cost increases shall be accepted in this initial contract term. Please consider this when providing pricing for the materials requested in this solicitation.

Thereafter, any extensions that may be approved by the Galveston County Commissioners' Court shall be subject to the provisions of the accompanying contract document.

If during the life of the contract, the successful bidder's net prices to other customers for uniforms awarded therein are reduced below the contracted price, it is understood and agreed that the benefits of such reduction shall be extended to Galveston County.

The bidder's past experience of honoring contracts at the bid price will be an important consideration in the evaluation of the lowest and best bid.

SPECIAL PROVISIONS
SHERIFF DEPARTMENT UNIFORMS & SUPPLIES
GALVESTON COUNTY, TEXAS

Any requests for price increases must be made in writing on company letterhead and addressed to the Galveston County Purchasing Agent. The requests shall be accompanied by written documentation from company suppliers and manufacturers of the requested materials that evidence the extenuating circumstances. Likewise, if any decreases occur in the industry during the contractual period, the Contractor shall extend these decreases to the County without prior request from the County. Increases in freight rates, oil embargos, or other extenuating circumstances are governed by the General Provisions, page 3, Item 12, Pass Through Cost Adjustments. These particular requests may be allowed only if prior approved by the Galveston County Commissioners' Court. It is understood that rail freight rates are subject to increase or decrease by the regulatory authority.

The County may, after examination, refuse to accept the adjusted costs if they are not properly documented, or considered to be excessive, or if decreases are considered to be insufficient. In the event the County does not wish to accept the adjusted costs and the matter cannot be resolved to the satisfaction of the County, the Contract will be considered cancelled on the scheduled expiration date.

EXCEPTIONS:

Any exceptions to bid conditions should be listed on a separate sheet of paper, attached to bid submittal and submitted with bid at the specified date and time of bid opening.

DELIVERY:

Uniforms will be delivered F.O.B., Point of Delivery.

Galveston County Sheriff's Department
Justice Center
601 59th Street
Galveston, Texas 77553

VENDOR STOCK:

The successful bidder must stock sufficient uniforms to supply the County requirements in a timely manner.

QUANTITIES:

Quantities shown on the attached bid sheet are for bidding purposes only. The County guarantees no minimum purchase and will pay only for uniforms actually ordered and furnished to Galveston County. Galveston County expects the awarded vendor to keep on hand a reasonable variety of stocked sizes to be purchased by Galveston County as needed. Articles should include the following: Pants size 28-52 and shirts size 14-20. Galveston County has tried to give an example of the quality of material that is expected.

INVOICING:

Invoices in **duplicate** shall be submitted to the:

Galveston County Auditor's Office
P.O. Box 1418
Galveston, Texas 77553

PURCHASE ORDER:

A Purchase Order will be required for each delivery made to the Galveston County Sheriff Department. Failure to include the Purchase Order number on invoices will result in delay in payment.

**SPECIAL PROVISIONS
SHERIFF DEPARTMENT UNIFORMS & SUPPLIES
GALVESTON COUNTY, TEXAS**

FITTINGS FOR UNIFORMS:

The successful vendor will be required to have a representative on hand at the Sheriff's Office, every Wednesday, from 9:00 a.m. to 10:00 a.m.

PERFORMANCE:

Failure to perform in accordance with any of the above provisions will be cause for cancellation of contract upon receipt of written notice from Galveston County.

SAMPLES:

The successful vendor will be required to submit samples of trouser, shirt, wind breaker, raincoat, and winter coat for specifications compliance before the bid will be awarded.

It is the intention of Galveston County to secure a tailored shirt equal in quality of workmanship and style to the shirt now on display as a sample.

INITIAL FITTING/ALTERATIONS

Successful bidder agrees to an emergency alteration turnaround time of 48 hours after receipt of article from Sheriff's Department personnel.

The following list of specifications concerning material, workmanship and service are the minimal acceptable requirements for this department.

The remainder of page intentionally left blank.

MEN'S SHIRT SPECIFICATIONS
Flying Cross by Fechheimer Item: 35R5806

FABRIC:

Content:

65% Dacron Polyester / 35% Combed Cotton

Weight:

6.5 oz. / square yard

COLOR:

Spruce Green.

STYLE:

To be Flying Cross Model 35R5806. Dress style, top center placket front, full cut tapered fit, convertible sport collar, long sleeves with barrel cuffs and dress shirrtail. Two pleated breast pockets with topstitched scalloped flaps. Topstitched shoulder straps. Full badge reinforcement. Back to have topstitched double yoke of shirting material. Work wear industrial style shirt construction is unacceptable and shall be cause for rejection.

COLLAR:

Convertible collar shall be one piece. Collar points to measure 3" long with ultrasonically fused-in Mylar stays. Collar to have woven interlining of #250 Dacron. Stays to be 2-3/4" long, 3/8" minimum width, and to be fused to under side of collar interlining. Stays applied directly to collar material itself unacceptable. Topstitched 1/4" off the edge. Collar material itself (top or underside) shall have no fusing to Mylar stays or collar interlining.

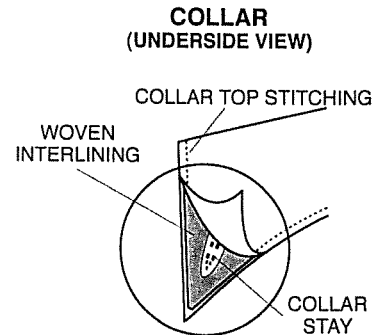

FRONT:

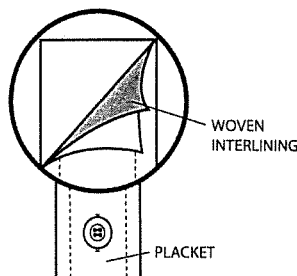

Each front shall have a facing approximately 3" in width. The left front shall have a top center placket 1-1/2" wide with two rows of stitches 7/8" apart. Stitching on the top center is not to be visible on the turn back facing. The shirt will have 7 buttons and buttonholes on the front; spacing between each will be 3-3/4" except the spacing between the neck button and the first button on the front, which will be approximately 3-1/4". Top center placket to have woven interlining of #250 Dacron. Non-woven interlining unacceptable and shall be cause for rejection. The fronts shall be joined to the yoke so that both raw edges of the yoke are turned under, with the front sandwiched between, and then all three are stitched down with a 1/16" raised stitch. Safety stitch joining unacceptable.

SHOULDER STRAPS:

Shoulder straps to be two-piece pointed, 1/4" topstitched and to be set on yoke with leading topstitch conforming with front joining seam. To measure 2" at sleeve tapering to 1-3/8" and set not more than 1/2" from collar set seam. Cross-stitched approximately 2" from sleeve seam. Shoulder strap to be stitched to the shoulder at the point with the button sewn over an uncut buttonhole. Edge stitched shoulder strap construction unacceptable.

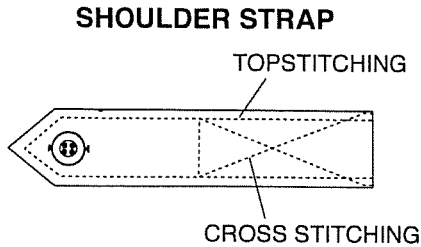

BADGE REINFORCEMENT:

Two-ply sling 1" wide centered over left pocket and stitched to shoulder seam and flap setting stitch. It shall have 2 (two) buttonhole eyelets 1-1/4" from top of pocket flap spaced 1-1/4" apart and centered on sling.

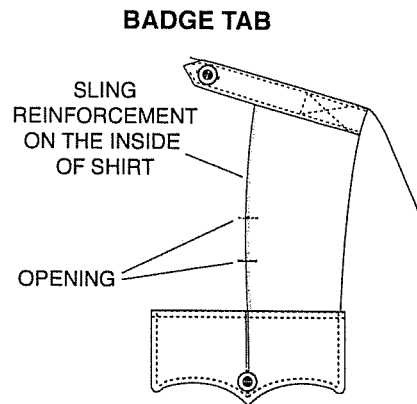

POCKETS:

Two breast patch pockets with mitered corners and 1-1/2" stitched pleats. Pleats shall be stitched top and bottom and full length of pleat to prevent spreading. Pocket to measure 5-5/8" wide, 6" deep. Left breast pocket to have 1- 1/2" pencil stitch. Each pocket to have hook Velcro, 3/4" long by 1/2" wide, positioned on both edges of pocket to correspond with outer scalloped flap points as specified. Velcro to be stitched all sides and to be sewn through pocket and shirt for added reinforcement.

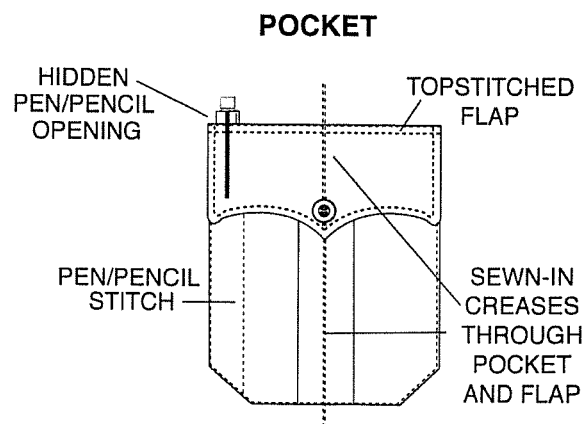

FLAPS:

Two piece deep scalloped design to measure 5-7/8" across and 2-3/4" in depth at center point, 2-1/4" at sides. Secured to shirtfront approximately 3/8" above pocket. Left flap to have invisible pencil opening 1-1/2" to correspond precisely with pencil slot of pocket. (Stop & start stitching for pencil opening unacceptable and shall be cause for rejection.) Flaps to be 1/4" topstitched. Flaps to have woven interlining of #250 Dacron. Creased and edge stitched pocket flap construction unacceptable. Under side of the flap to have looped Velcro 3/4" long by 1/2" wide stitched all sides, positioned on outer points of both pocket flaps to secure with corresponding Velcro strips on shirt pocket. Each flap shall have a button centered on uncut sewn buttonhole.

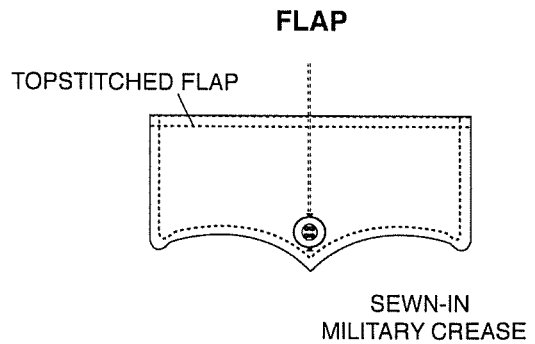

SLEEVES:

Sleeve vent shall be a minimum of 4-1/2" long with one-piece top and bottom facings. Facing to measure 1-1/8" wide point blocked at top.

ADJUSTABLE CUFF

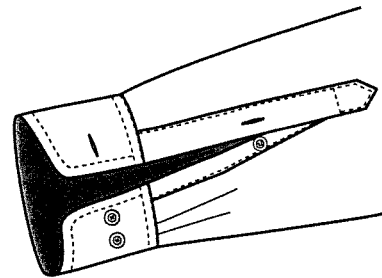

CUFFS:

Two piece 1/2-inch hemmed cuff with 1/4" topstitching. Cuffs to measure 2 1/2" in depth with rounded corners (barrel cuffs). Two button adjustable cuff with one button and buttonhole in center of facing. Cuffs to have woven interlining of #250 Dacron.

BUTTONS:

First grade 19-ligne pearlescent.

SEWING:

Collar, cuffs, shoulder straps and pocket flaps to be topstitched 1/4" off the edge. Sleeve inserting and side close felling seams are to be safety stitched.

THREAD:

All sewing threads to be color fast polyester wrap to match.

INTERLINING:

Collar, pocket flaps, cuffs and top center to be interlined with #250 Dacron.

MILITARY CREASES:

There shall be five stitched-in sharp military creases on all shirts. One crease on each front to be centered vertically. Front creases shall be through pockets and flaps. Spacing for three military creases across shirt back to be proportionate to the size of the shirt.

CONSTRUCTION:

Collar, cuffs and flaps are made with conventional construction. Top ply, bottom ply and interlining are first stitched together, then turned right side out and finally topstitched.

EMBLEMS

Galveston County Sheriff's Office emblems sewn on each sleeve

EMBROIDERY AND NAMESTRIP

Galveston County CORRECTIONS or COMMUNICATIONS logo embroidered over left chest. Black namestrip with deputies first initial and last name sewn over right chest.

STOCK SIZES:

Shirts must be available in the following sizes:

XSMALL – 4XL

Alpha sleeve lengths:

Short to finish 32"

Regular to finish 34"

Long to finish 36"

MEN'S SHIRT SPECIFICATIONS
Flying Cross by Fechheimer Item: 85R5806

FABRIC:

Content:

65% Dacron Polyester / 35% Combed Cotton

Weight:

6.5 oz. / square yard

COLOR:

Spruce Green.

STYLE:

To be Flying Cross Model 85R5806. Dress style, top center placket front, full cut tapered fit, convertible sport collar, short sleeves and dress shirttail. Two pleated breast pockets with topstitched scalloped flaps. Topstitched shoulder straps. Full badge reinforcement. Back to have topstitched double yoke of shirting material. Work wear industrial style shirt construction is unacceptable and shall be cause for rejection.

COLLAR:

Convertible collar shall be one piece. Collar points to measure 3" long with ultrasonically fused-in Mylar stays. Collar to have woven interlining of #250 Dacron. Stays to be 2-3/4" long, 3/8" minimum width, and to be fused to under side of collar interlining. Stays applied directly to collar material itself unacceptable. Topstitched 1/4" off the edge. Collar material itself (top or underside) shall have no fusing to Mylar stays or collar interlining.

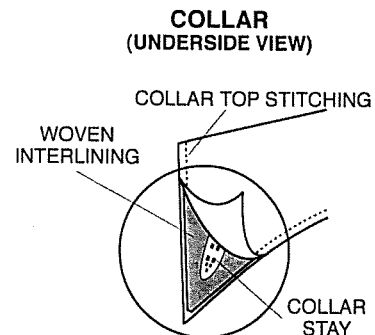

FRONT:

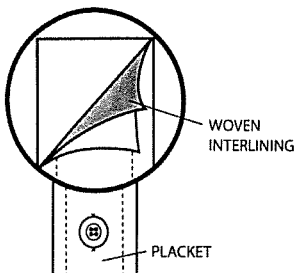

Each front shall have a facing approximately 3" in width. The left front shall have a top center placket 1-1/2" wide with two rows of stitches 7/8" apart. Stitching on the top center is not to be visible on the turn back facing. The shirt will have 7 buttons and buttonholes on the front; spacing between each will be 3-3/4" except the spacing between the neck button and the first button on the front, which will be approximately 3-1/4". Top center placket to have woven interlining of #250 Dacron. Non-woven interlining unacceptable and shall be cause for rejection. The fronts shall be joined to the yoke so that both raw edges of the yoke are turned under, with the front sandwiched between, and then all three are stitched down with a 1/16" raised stitch. Safety stitch joining unacceptable.

SHOULDER STRAPS:

Shoulder straps to be two-piece pointed, 1/4" topstitched and to be set on yoke with leading topstitch conforming with front joining seam. To measure 2" at sleeve tapering to 1-3/8" and set not more than 1/2" from collar set seam. Cross-stitched approximately 2" from sleeve seam. Shoulder strap to be stitched to the shoulder at the point with the button sewn over an uncut buttonhole. Edge stitched shoulder strap construction unacceptable.

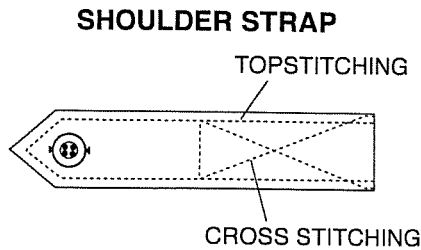

BADGE REINFORCEMENT:

Two-ply sling 1" wide centered over left pocket and stitched to shoulder seam and flap setting stitch. It shall have 2 (two) buttonhole eyelets 1-1/4" from top of pocket flap spaced 1-1/4" apart and centered on sling.

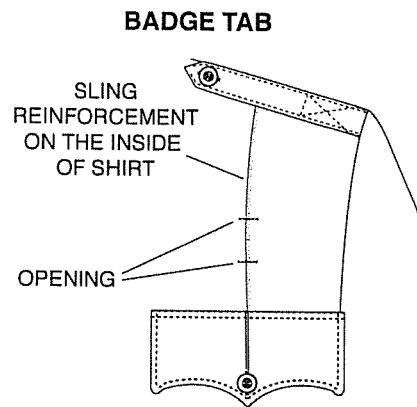

POCKETS:

Two breast patch pockets with mitered corners and 1-1/2" stitched pleats. Pleats shall be stitched top and bottom and full length of pleat to prevent spreading. Pleats to measure 5-5/8" wide, 6" deep. Left breast pocket to have 1- 1/2" pencil stitch. Each pocket to have hook Velcro, 3/4" long by 1/2" wide, positioned on both edges of pocket to correspond with outer scalloped flap points as specified. Velcro to be stitched all sides and to be sewn through pocket and shirt for added reinforcement.

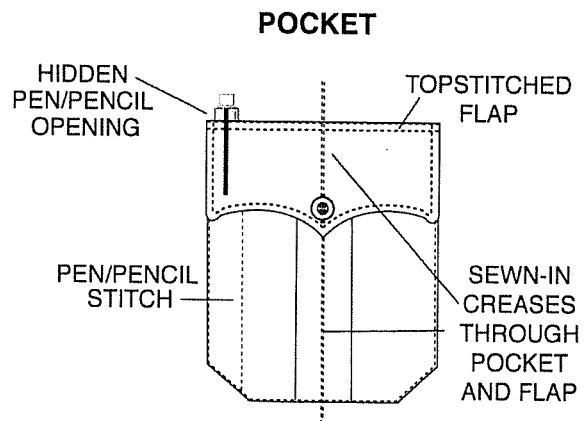

FLAPS:

Two piece deep scalloped design to measure 5-7/8" across and 2-3/4" in depth at center point, 2-1/4" at sides. Secured to shirtfront approximately 3/8" above pocket. Left flap to have invisible pencil opening 1-1/2" to correspond precisely with pencil slot of pocket. (Stop & start stitching for pencil opening unacceptable and shall be cause for rejection.) Flaps to be 1/4" topstitched. Flaps to have woven interlining of #250 Dacron. Creased and edge stitched pocket flap construction unacceptable. Under side of the flap to have looped Velcro 3/4" long by 1/2" wide stitched all sides, positioned on outer points of both pocket flaps to secure with corresponding Velcro strips on shirt pocket. Each flap shall have a button centered on uncut sewn buttonhole.

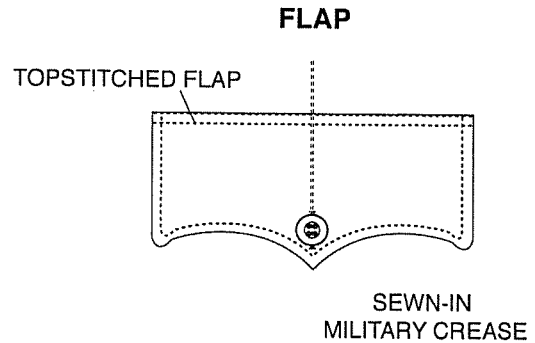

SLEEVES:

Sleeves are to be straight and whole and to have a 3/4" hem and to finish at a minimum of 9 1/2" long from shoulder seam.

BUTTONS:

First grade 19-ligne pearlescent.

SEWING:

Collar, shoulder straps and pocket flaps to be topstitched 1/4" off the edge. Sleeve inserting and side close felling seams are to be safety stitched.

THREAD:

All sewing threads to be color fast polyester wrap to match.

INTERLINING:

Collar, pocket flaps and top center to be interlined with #250 Dacron.

MILITARY CREASES:

There shall be five stitched-in sharp military creases on all shirts. One crease on each front to be centered vertically. Front creases shall be through pockets and flaps. Spacing for three military creases across shirt back to be proportionate to the size of the shirt.

CONSTRUCTION:

Collar and pocket flaps are made with conventional construction. Top ply, bottom ply and interlining are first stitched together, then turned right side out and finally topstitched.

EMBLEMS:

Galveston County Sheriff's Office Emblems will be sewn on each shoulder

EMBROIDERY AND NAMESTRIP

Galveston County CORRECTIONS or COMMUNICATIONS logo embroidered over left chest. Black namestrip with deputies first initial and last name sewn over right chest.

STOCK SIZES:

Shirts must be available in the following sizes:
XSMALL - 4XL

HORACE SMALL®

SENTRY PLUS SPECIFICATIONS

Men's Long Sleeve Shirt Zipper Front

HS1544

FABRIC

Solid: 100% polyester, texturized woven. Weight 7.25 oz. per yard. single warp, two ply filling.

Color: Spruce Green

CREASING

There are two sewn in permanent military creases in front and three in back.

FRONT

The left front has a self-fabric center pleat 1-3/8" wide extending from collar band to bottom of shirt. The center pleat has two rows of stitching 7/8" apart and is interlined with 100% polyester, 250 denier. A self-lined button stand 7/8" wide is on the right side and extends from collar band to bottom of shirt. There are six front buttons and one collar button.

COLLAR

The collar is banded. The back of the stand measures 1½". The points are 3" in length and top stitched 3/16" from the edge. The interlinings are 100% polyester, 250 denier. Collar band has crease interlining. Permanent collar stays of proper length are fused or sewn inside collar so that no stitches are made through the bottom leaf. The stand fastens with one button.

YOKE

Two piece yoke of self-goods. The back of the yoke is topstitched 1/16".

SLEEVES

Each sleeve has a one piece pointed placket 1¼" wide both top and bottom, with one button and buttonhole centered in the vent opening. Sleeve setting and closing are sewn with an overedge and safety stitch. Cuffs close with two buttons and buttonholes, are 2¼" wide and have ¼" topstitching on the edge. Cuffs are interlined.

POCKETS

Two breast pockets finishing 5-3/8" wide and 5¾" long with mitered corners. Both pockets have a 1½" box-pleat stitched top and bottom to prevent spreading. Left pocket has a sewn through pencil stall 1-3/8" wide. Woven hook fastener ½" wide and 1" long is placed on each pocket to secure woven loop fastener placed on each flap.

FLAPS

Flaps are scalloped, finishing 5½" in width, 2¾" in length at the center and 2½" at each side. Flaps are placed with a ¼" space between the pocket and flap and have one centered buttonhole with button. The left flap has a pencil opening 1-3/8" wide. Woven loop fastener ½" wide and 1" long is placed on edges of each flap to secure woven hook fastener placed on pockets. Flaps have crease interlining.

BADGE TAB

Inside sling type of self-goods approximately 1-1/8" wide extends from joining seam to pocket of left front. To have two small, uncut buttonholes 1¼" apart with the lower buttonhole 1¼" above the flap. **Sling must be nylon reinforced for added strength.**

EPAULETS

Sewn into sleeve head seam and measure approximately 1-7/8" tapering to 1½" with end pointed. Epaulets are set approximately 1" from the collar seam. They are box-stitched to shoulders with a row of x-stitching 2½" from sleeve head and diagonally sewn from each end of the seam to the sleeve. Epaulets have crease interlining. **Epaulet will be spruce green and tan piggyback.**

SHIRT LABELING

Each garment is identified by permanent size, style number, cut number, fiber content, manufacturing RN number, care instructions and country of origin labeling.

BUTTONS

20-ligne melamine buttons dyed to match the fabric color.

PACKING

Shirts are polybagged individually.

ZIPPER CLOSURE

Shirt shall have a 14" nylon separating zipper.

PATCHES

Galveston Co. Sheriff's Office shoulder patches will be sewn on each shoulder.

WARRANTY

One year against workmanship or fabric defects.

09/05

HORACE SMALL

SENTRY PLUS SPECIFICATIONS

Women's Long Sleeve Shirt With Zipper Front HS1545

FABRIC

100% polyester, texturized woven. Weight 7 oz. per yard. Tropical weave, single warp, two ply filling.
Color: Spruce Green

CREASING

There are two sewn in permanent military creases in front and three in back.

FRONT

The right front has a self-fabric center pleat 1-3/8" wide with a 3/4" wide facing extending from neckline to bottom of shirt. It has two rows of stitching 7/8" apart. The center pleat is interlined with 100% polyester, 250 denier. The right front has seven buttonholes. The left front has a 3/4" revere facing extending from collar to bottom of shirt. Eyelets and stay tacks are sewn on the left front with buttons sewn centered over each eyelet for metal button feature. The left front has seven buttons. The right front buttons over the left front.

COLLAR

Convertible collar measures 2-7/8" in length at points and is top stitched 3/16" from the edge. The interlinings are 100% polyester, 250 denier. Permanent collar stays of proper length are fused or sewn inside the collar so that no stitches are made through the bottom leaf.

YOKE

Two piece yoke of self-goods. The back of the yoke is topstitched 1/16".

SLEEVES

Each sleeve has a one piece pointed placket 1 1/4" wide both top and bottom, with one button and buttonhole centered in the vent opening. Sleeve setting and closing are sewn with an overedge and safety stitch. Cuffs close with two buttons and buttonholes, are 2 3/4" wide and have 1/4" topstitching on the edge. A coverstrip is sewn inside the cuff for the metal button feature. Cuffs are interlined.

POCKETS

Two breast pockets finishing 5-3/8" wide and 5 3/4" long with mitered corners. Both pockets have a 1 1/2" box-pleat stitched top and bottom to prevent spreading. Left pocket has a sewn through pencil stall 1-3/8" wide. Woven hook fastener 1/2" wide and 1" long is placed on each pocket to secure woven loop fastener placed on each flap.

FLAPS

Flaps are scalloped, finishing 5 1/2" in width, 2 3/4" in length at the center and 2 1/2" at each side. Flaps are placed with a 1/4" space between the pocket and flap and have one centered buttonhole with button. The left flap has a pencil opening 1-3/8" in width. Woven loop fastener 1/2" wide and 1" long is placed on edges of each flap to secure woven hook fastener placed on pockets. Flaps have crease interlining.

BADGE TAB

Inside sling type of self-goods approximately 1-1/8" wide extends from joining seam to pocket of left front. To have two small uncut buttonholes 1¼" apart with the lower buttonhole 1¼" above the flap. **Sling must be nylon reinforced for added strength.**

EPAULETS

Sewn into sleeve head seam and measure approximately 1-7/8" tapering to 1½" with end pointed. Epaulets are set approximately 1" from the collar seam. They are box-stitched to shoulders with a row of x-stitching 2" from sleeve head and diagonally sewn from each end of the seam to the sleeve. Epaulets have crease interlining. Epaulet will be green with a tan bead around edges. **Epaulets will be spruce green and tan piggyback.**

SHIRT LABELING

Each garment is identified by permanent size, style number, cut number, fiber content, manufacturing RN number, care instructions and country of origin labeling.

BUTTONS

20-ligne melamine buttons dyed to match the fabric color.

ZIPPER FRONT

Shirts shall have a 14" separating zipper front.

PATCHES

Galveston Co. Sheriff's Office shoulder patches will be sewn on each shoulder.

PACKING

Shirts to be polybagged individually.

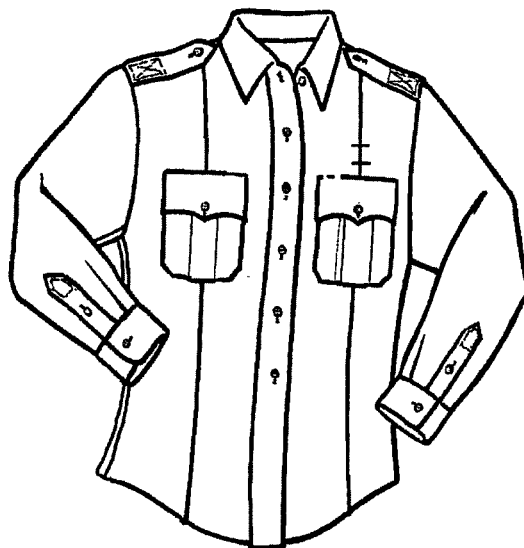

HORACE SMALL®

SENTRY PLUS SPECIFICATIONS

Men's Short Sleeve Shirt Zipper Front

HS1546

FABRIC

Solid: 100% polyester, texturized woven. Weight 7.25 oz. per yard. Single warp, two ply filling.
Color: Spruce Green.

CREASING

There are two sewn in permanent military creases in front and three in back.

FRONT

The left front has a self-fabric center pleat 1-3/8" wide extending from collar band to bottom of shirt. It has two rows of stitching 7/8" apart. The center pleat is interlined with 100% polyester, 250 denier. Right front has a 3-1/8" revere facing extending from neckline to bottom of shirt. There are seven front buttons.

COLLAR

Convertible collar measures 2-7/8" long at points and is topstitched 3/16" from the edge. The interlinings are 100% polyester, 250 denier. Permanent collar stays of proper length are fused or sewn inside collar so that no stitches are made through the bottom leaf.

YOKE

Two piece yoke of self-goods. The back of the yoke is topstitched 1/16".

SLEEVES

Sleeves are one piece, have a 7/8" hem and finish 10-3/8" long from the shoulder seam on a size Large. Sleeve setting and closing are sewn with an overedge and safety stitch. The sleeve is bartacked at the hem.

POCKETS

Two breast pockets finishing 5-3/8" wide and 5¾" long with mitered corners. Both pockets have a 1½" box-pleat stitched top and bottom to prevent spreading. Left pocket has a sewn through pencil stall 1-3/8" wide. Woven hook fastener ½" wide and 1" long is placed on each pocket to secure woven loop fastener placed on each flap.

FLAPS

Flaps are scalloped, finishing 5½" in width, 2¾" in length at the center and 2½" at each side. Flaps are placed with a ¼" space between the pocket and flap and have one centered buttonhole with button. The left flap has a pencil opening 1-3/8" wide. Woven loop fastener ½" wide and 1" long is placed on edges of each flap to secure woven hook fastener placed on pockets. Flaps have crease interlining.

BADGE TAB

Inside sling type of self-goods approximately 1-1/8" wide extends from joining seam to pocket of left front. To have two small, uncut buttonholes 1¼" apart with the lower buttonhole 1¼" above the flap. **Sling must be nylon reinforced for added strength.**

EPAULETS

Sewn into sleeve head seam and measure approximately 1-7/8" tapering to 1½" with end pointed. Epaulets are set approximately 1" from the collar seam. They are box-stitched to shoulders with a row of x-stitching 2½" from sleeve head and diagonally sewn from each end of the seam to the sleeve. Epaulets have crease interlining. **Epaulet will be spruce green and tan piggyback.**

SHIRT LABELING

Each garment is identified by permanent size, style number, cut number, fiber content, manufacturing RN number, care instructions and country of origin labeling.

BUTTONS

20-ligne melamine buttons dyed to match the fabric color.

PACKING

Shirts are polybagged individually.

PATCHES

Galveston Co. Sheriff's Office shoulder patches will be sewn on each shoulder.

ZIPPER CLOSURE

Shirt shall have a 14" nylon separating zipper.

09/05

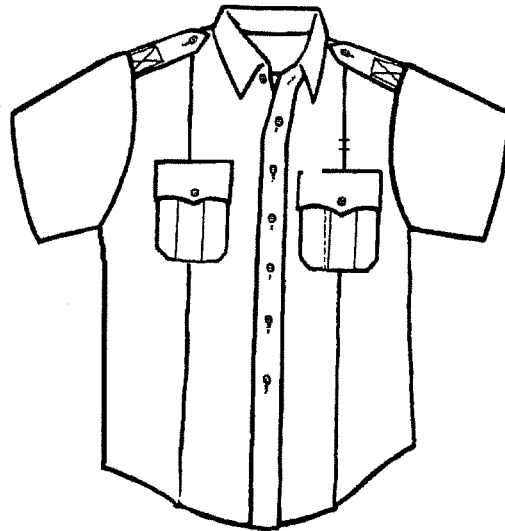

HORACE SMALL®

SENTRY PLUS SPECIFICATIONS

Women's Short Sleeve Shirt With Zipper Front HS1547

FABRIC

100% polyester, texturized woven. Weight 7.25 oz. per yard. Single warp, two ply filling. Color: Spruce Green.

CREASING

There are two sewn in permanent military creases in front and three in back.

FRONT

The right front has a self-fabric center pleat 1-3/8" wide with a 3-1/8" facing extending from neckline to bottom of shirt. It has two rows of stitching 7/8" apart. The center pleat is interlined with 100% polyester, 250 denier. The right front has seven buttonholes. The left front has a 3-1/8" reverse facing extending from neckline to bottom of shirt. Eyelets and tacks are sewn on the left front with buttons sewn centered over each eyelet for metal button feature. The left front has seven buttons.

COLLAR

Convertible collar measures 2-7/8" in length at points and is top stitched 3/16" from the edge. The interlinings are 100% polyester, 250 denier. Permanent collar stays of proper length are fused or sewn inside the collar so that no stitches are made through the bottom leaf.

YOKE

Two piece yoke of self-goods. The back of the yoke is topstitched 1/16".

SLEEVES

Sleeves are one piece, have a 7/8" hem and finish approximately 9" long from the shoulder seam on a size Medium. Sleeve setting and closing are sewn with an overedge and safety stitch. The sleeves are bartacked at the hem.

POCKETS

Two breast pockets finishing 5-3/8" wide and 5¾" long with mitered corners. Both pockets have a 1½" box-pleat stitched top and bottom to prevent spreading. Left pocket has a sewn through pencil stall 1-3/8" wide. Woven hook fastener ½" wide and 1" long is placed on each pocket to secure woven loop fastener placed on each flap.

FLAPS

Flaps are scalloped, finishing 5½" in width, 2¾" in length at the center and 2½" at each side. Flaps are placed with a ¼" space between the pocket and flap and have one centered buttonhole with button. The left flap has a pencil opening 1-3/8" in width. Woven loop fastener ½" wide and 1" long is placed on edges of each flap to secure woven hook fastener placed on pockets. Flaps have crease interlining.

BADGE TAB

Inside sling type of self-goods approximately 1-1/8" wide to extend from joining seam to pocket of left front. To have two small uncut buttonholes 1¼" apart with the lower buttonhole ¼" above the flap. **Sling must be nylon reinforced for added strength.**

EPAULETS

Sewn into sleeve head seam and measure approximately 1-7/8" tapering to 1½" with end pointed. Epaulets are set approximately 1" from the collar seam. They are box-stitched to shoulders with a row of x-stitching 2" from sleeve head and diagonally sewn from each end of the seam to the sleeve. Epaulets have crease interlining. Epaulet will be green with a tan bead around edges. **Epaulets will be spruce green and tan piggyback**

SHIRT LABELING

Each garment is identified by permanent size, style number, cut number, fiber content, manufacturing RN number, care instructions and country of origin labeling.

BUTTONS

20-ligne melamine buttons dyed to match the fabric color.

ZIPPER FRONT

Shirts shall have a 14" separating zipper front.

PATCHES

Galveston Co. Sheriff's Office shoulder patches will be sewn on each shoulder.

PACKING

Shirts are polybagged individually.

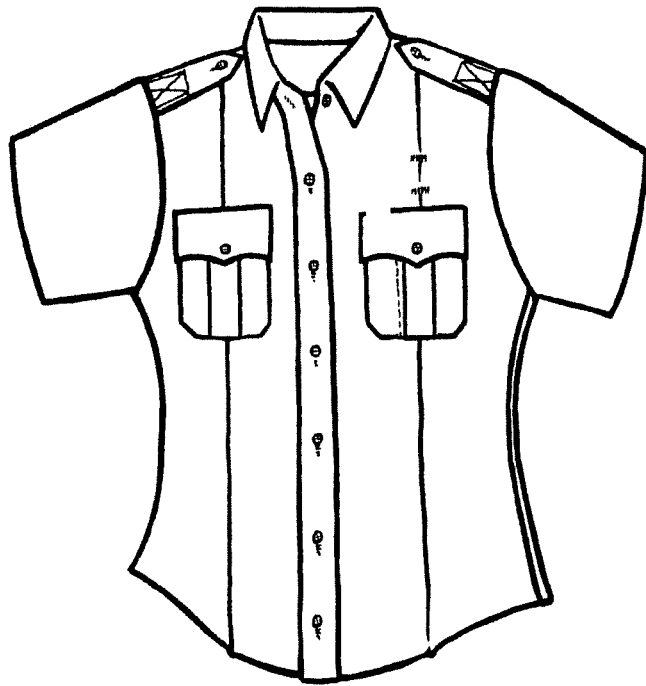

HORACE SMALL®
SENTRY PLUS SPECIFICATIONS
Women's Function Fit™ Trousers
HS2713

FABRIC

100% polyester. Burlington Style 617-A872 Two ply warp and filling, 10.5 - 11 oz. per linear yard, 2 x 1 gabardine weave.
Color: Spruce Green

DESIGN

Shall be made on a modified ladies uniform pattern with quarter top front pockets and two back pockets. Lowered rise front with modest rise back allows comfortable fit while in the patrol car or on foot pursuit. Positioning the duty belt at the natural waist gives support and comfort. Comfort stretch waistband enables custom fit to many different body types allowing wearer to adjust waist band up and down the torso for comfort. Comfort stretch also eliminates unsightly gaping at the back. Generous fit through hips, seat and thigh increases comfort and mobility. Stretching up to 2" - 4", the Horace Small Comfort Cool Flex® Waistband stretches with the officer, helping her do her job with ease.

POCKETS

The front pocket opening will be a minimum 6" and be 5½" deep from the bottom of the opening. They shall be stitched, turned, and restitched. The inside front pocket facing shall be a separate piece of self material finishing no less than 1¼" wide. The back pockets will have a minimum opening of 5½" and be 6" deep on size 14 and up. On size 12 and down, the minimum opening will be 5" wide and 6" deep. They shall be made with a Reese PW automatic machine and finished on the outside with an exposed top and bottom cord. The left pocket shall have a tab to button. The front pockets will have straight bar tacks. The back pockets shall be bar tacked with a triangular bar tacking machine.

POCKETING

All pocketing shall be black, 70% polyester/30% cotton. The weight shall be 3.2 yds/lb.

WAISTBAND

The waistband is to finish 2" wide and will be closed with two crush-proof hooks and eyes, the eyes being bar tacked for stability. The band is attached to a 2 ½" Cool Flex® curtain with two silicone beads along the full length of the band as well as Ban-Rol Sofflex™ elastic, ¾" wide. The waistband is to be set on and stitched below the lower edge through the outer fabric and the waistband curtain. The Comfort Cool Flex® band allows stretch of 2" - 4" depending on the size of the trouser. The trousers are to be made with a continuous closed waistband having center back outlet for tailoring.

INSIDE TRIM

The right fly shall be the same fabric and color as the waistband curtain. The right fly lining shall be sewn to the left fly below the zipper.

BELT LOOPS

There shall be a minimum of five (5) belt loops on waist sizes 12 and down, and a minimum of seven (7) on all sizes over 14. Each loop is to be ¾" wide, interlined, of double thickness, and stitched on the face

HORACE SMALL®
SENTRY PLUS SPECIFICATIONS
Women's Function Fit™ Trousers
HS2713

side with a two needle machine. All loops will be sewn into the bottom of the waistband and into the rocap except for the center back loop, which shall be tacked on. They shall accommodate a 1-5/8" belt.

ZIPPER

The trousers shall be closed with a YKK brass zipper which has a brass bottom stop at the base of the zipper chain and a brass ratcheting cam lock slider. The inside left fly will be reinforced with Pellon under the zipper stitching. A straight bar tack shall be sewn through from the outside of the garment to the inside at the bottom of the fly. It shall be sewn through the zipper tape, the right and left fly and the right fly lining. The right and left fly shall be joined by an additional bar tack located below the bottom zipper stop on the inside of the trouser.

SEAMING

The entire trouser is to be seamed with polyester core thread. The seat seam shall be stitched with a tandem needle seat seaming machine. All exposed inside seams of the trouser are to be serged. The inseam and outseam shall be sewn with a 401 chain stitch and seam busted open as traditional tailoring method allowing pants to drape smoothly with no puckers or pulls.

STRIPING

There will be a tan inlaid stripe from the bottom of the pocket down.

LABELING

Trousers shall be labeled with the following information: style number, size, fiber content, care instructions and country of origin.

FINISHING AND PRESSING

All loose threads shall be removed. Trousers must be pressed completely and properly with the side seam, inseam, and seat seam pressed open.

WARRANTY

One year against workmanship or fabric defects.

06/15

HORACE SMALL®

SENTRY PLUS SPECIFICATIONS

Men's Trouser - Traditional Style HS2712

FABRIC

100% polyester. Burlington Style 617-A872 Two ply warp and filling, 10.5 - 11 oz. per linear yard, 2 x 1 gabardine weave. Color: Spruce Green

DESIGN

Shall be made on a uniform pattern, having a plain front with quarter top pockets and two back pockets.

POCKETS

The front pocket opening will be a minimum 6½" and be 6" deep from the bottom of the opening. They shall be stitched, turned, and restitched. The inside front pocket facing shall be a separate piece of self material finishing no less than 1¼" wide. The back pockets will have a minimum opening of 5½" and be 6" deep. Sizes 29 and smaller will have a 5" opening. They shall be made with a Reese PW automatic machine and finished on the outside with an exposed top and bottom cord. The left pocket shall have a tab to button. The front pockets shall each have a straight bar tack and each back pocket shall be bar tacked with a triangular bar tacking machine.

POCKETING

All pocketing shall be black, 70% polyester/30% cotton with a minimum thread count of 90 x 56. The weight shall be 3.2 yds/lb.

WAISTBAND

The waistband shall be 2" wide and shall close with two crush-proof hook and eye, the eye being bar tacked for stability. The band is attached to a 2 ½" Cool Flex curtain with two silicone beads along the full length of the band as well a Ban-Rol Sofflex elastic ¼" wide. The waistband is to be set on and stitched below the lower edge through the outer fabric and waistband curtain. The Comfort Cool Flex band allows stretch of 2" – 4" depending on the size of the trouser. The trousers are made with a continuous closed waistband having center back outlet for tailoring.

INSIDE TRIM

The right fly and crotch linings shall be the same fabric and color as the waistband curtain. The right fly lining shall be sewn to the left fly below the zipper. The crotch lining shall be serged to each front. A separate French fly made of the outer fabric shall be sewn to the inside right fly.

BELT LOOPS

There shall be a minimum of five (5) belt loops on waist sizes 30 and down, seven (7) belt loops on waist sizes 31 - 48, and a minimum of nine (9) on sizes 50 and larger. Each loop is to be ¾" wide, of double thickness, and stitched on the face side with a two needle machine. Except for the center back loop which shall be tacked on, all loops shall be sewn into the bottom of the waistband and into the rocap. They shall accommodate a 1-5/8" belt.

ZIPPER

The trousers shall be closed with a YKK brass zipper which has a brass bottom stop at the base of the zipper chain and a brass ratcheting cam lock slider. The inside left fly will be reinforced with Pellon under the zipper stitching. A straight bar tack shall be sewn through from the outside of the garment to the inside at the bottom of the fly. It shall be sewn through the zipper tape, the right and left fly and the right fly lining. The right and left fly shall be joined by an additional bar tack located below the bottom zipper stop on the inside of the trouser.

SEAMING

The entire trouser is to be seamed with polyester core thread. The seat seam shall be stitched with a tandem needle seat seaming machine. All exposed inside seams of the trouser are to be serged.

STRIPING

There will be a tan inlaid stripe from the bottom of the pocket down.

LABELING

Trousers shall be labeled with the following information: style number, size, fiber content, care instructions, WPL number and country of origin.

FINISHING AND PRESSING

All loose threads shall be removed. Trousers must be pressed completely and properly with the side seam, inseam, and seat seam pressed open.

06/15

**BREAK-AWAY HIGH VISIBILITY SAFETY VEST
COLOR: FLUORESCENT YELLOW**

GENERAL REQUIREMENTS

1. Failure to complete the compliance questions following each section below will result in automatic rejection of such bids as non-responsive.
2. All garment details not specifically described herein, tailoring, styling, construction, materials, and components must match the standard reference sample.
3. Pre-bid samples required at the time of the bid opening.
4. Samples may be subjected to laboratory testing at the discretion of the contracting officer. Bidders are responsible for all testing costs of their sample garments.
5. Bidders must enclose evidence (dated manufacturers catalogs or similar) that this item is currently a commercial in-stock style. The successful bidder will provide a full size run of try-on garments within 10 days for agency approval.
6. Garments will have a warranty covering (at minimum) defects in materials and workmanship for one (1) year.
7. Garment must be ANSI/ISEA 107-2004 Class I third party certified.
8. Garments must be manufactured to ISO 9001 quality assurance standard. (AGO1 19)

SHELL FABRIC

9. 3.7 oz. per square yard, 100% Polyester heavy denier tricot. (Color: see specified garment color)

TRIM

10. Binding: 100% nylon plain weave taffeta (Color: black)
100% polyester plain weave taffeta (Color: fluorescent yellow)
11. Hook and loop: woven nylon base. (Color: fluorescent yellow)
12. Eyelets: aluminum, black enamel finish
13. Ribbon: 2.25-inches grosgrain. (Color: black)
14. Reflective trim: 2.0 inch wide, 3M Scotchlite silver reflective fabric.

DESIGN AND CONSTRUCTION

15. Full cut vest.
16. High contrast Scotchlite striping.
17. Pen/ penlight openings.
18. Microphone tabs on each shoulder.
19. Fully adjustable waist.
20. "Break Away" shoulder and side access.

CUSTOMIZATION (OPTIONAL)

21. Lettering. SHERRIFF on back of both sides in Scotchlite
22. Badge tab.

STANDARD SIZE RANGE

23. Unisex sizing:
- | | |
|----------|-----------|
| Regular: | SM-M |
| | L - XL |
| | 2XL - 3XL |

MEASUREMENTS

24. Regular Length: Size: L-XL
 - a. Across Chest: 18.5
 - b. Center Front Length: 13.625
 - c. Across Back: 19.5
 - d. Center Back Length: 21.38
-

ELBECO TEXTROP2
Male Long Sleeve Shirts

Style: It is the intention of this department to secure a tailored shirt equal in quality of workmanship and style to the shirt now on display as a sample. Elbeco Tex-Trop brand or pre-approved equal only.

Shirts will be cut on a form-fitting line, and the shape of the pockets and general style will conform to this sample.

Tailoring: It is imperative that this garment be constructed according to the principles set forth in the specifications. All stitches must be of the proper tension and size so as to avoid puckering after the shirt has been laundered and to give best durable press performance. All sewing shall be with Dacron core thread to match shirt fabric.

The collar and cuffs are to be single stitched 1/4" from edge. The pockets and flaps shall be single stitched on the edge.

Fabric: To insure permanent moisture control, superior breathability, soil resistance, easy care, wrinkle resistance, color matching, and color retention, the fabric is to be Burlington 100% texturized polyester plain weave with mechanical stretch, weighing 5.5 oz./sq. yd., 10 oz./lin. yd. Nano Moisture Wicking technology is applied at the fiber level to capture and pull fluids and perspiration away from the skin and spread it over the fabric surface for quick evaporation to keep the wearer dry and comfortable.

Creasing: Pockets and pocket flaps to be die creased to give uniform shape and size.

Collar: The shape and style of both leaf and stand shall conform to the TT89 banded collar. The points, medium spread, are to be approximately 3" in length. The back of the stand is to measure 1-1/2". The leaf shall be made of three pieces; two pieces of self cloth and one whole lining, which is to be fused to the top collar.

Inner stand and inner yoke to be made of matching 65% Dacron Polyester/35% Cotton, 4.2 ounce per square yard, 106 x 58.

Collar stays shall be of good quality Stalar vinyl, 2-1/2" in length and 3/8" wide and be attached to the bottom collar. The stand shall fasten with one button. There shall be one horizontal button hole.

Sleeves: To be straight and whole. The cuffs are to be 2-7/8" in width and to fasten with two buttons. There is to be a single stitch 7/16" from top of cuff.

The sleeve opening shall measure 4-7/8" from top of cuff. The top facing for this opening is to be 1-1/4" wide and the bottom facing to finish about 2" wide. Button is to be placed on sleeve opening with corresponding buttonhole.

ELBECO TEXTROP2
Male Long Sleeve Shirts

The sleeves must be secured to the body of the shirt by means of a merrow stitch with a safety stitch so as to properly strengthen the stitch. The same stitch must be used on the side closing seams as well.

Flex Vent: Patent pending Flex Vent is made from 92% polyester/8% spandex mesh. Diamond shaped mesh measuring 3 ¼" wide x 10 ¼" long is set into the sleeve and body panels at the underarm to allow for body heat ventilation and increased mobility and comfort.

Front: The front shall have a center facing 1-1/2" wide extending from the collar stand to bottom of shirt and be made of the same material as shirt fabric with two rows of stitching 7/8" apart.

The center front shall contain six vertical buttonholes placed 3/4" from edge and 3-1/2" apart. Buttons shall be securely attached to the right front and shall correspond to the buttonholes on the left front.

Back: There is to be yoke composed of an outer piece of the same material as the basic shirt, and an inner piece of poplin.

Dual Comm Access Openings:

Access opening measuring 1-1/2" are to be set in each side seam 1" below the bottom tip of the Flex Vent. Pouch style openings are clean-finished, neatly concealed and reinforced for durability. These opening are used to thread communication wires under the front of the shirt to keep them out of the way.

Pockets: There are two double entry chest pockets with mitered corners to finish 5-5/8" wide and 6" long. The side entry forms a utility pocket closed with Velcro. The left chest pocket to have a pencil compartment about 1-1/4" wide. Both pockets to have 1-1/4" box pleat stitched from top to bottom to prevent spreading.

Flaps: To have two scalloped flaps to finish 5-3/4" in length, 2-3/4" in width at center, and 2-1/2" in width at sides. Flaps to be secured to front of shirt with two rows of stitching approximately 1/4" above top of pocket. The left flap to have a pencil opening about 1-1/4" in width. Flaps to be interlined. There will be a matching button and a buttonhole sewn on the flap.

Flap Closure:

The side points of the flaps are to be secured to the pockets by means of velcro fasteners sewn onto the flaps and pockets.

ELBECO TEXTROP2
Male Long Sleeve Shirts

Badge Tab: To be reinforced on inside of the shirt by means of a strip of material 1-1/2" wide stitched and folded so that no raw edges show. The reinforcement strip is to extend from the flap setting stitch to the joining seam at the front of the yoke. To have two small (horizontal) buttonholes, 1-1/4" apart with the bottom buttonhole 1-1/2" above top of left flap.

Shoulder Straps:

The shoulder straps shall be pointed at the end toward the neck of the shirt. The other end shall be sewn in sleeve head seam. The pointed ends shall be fastened with one matching button. The straps shall measure 2" at sleeve and taper to 1-3/8". Straps to be set about 2" from the collar. Shoulder straps shall be box stitched to shoulders with row of cross stitching 2" from sleeve head seam.

Permanent Creases:

Shirt to have permanent military creases. Creases to be stitched in shirt only, not thru pockets and flaps. One crease in each front extending from hem to joining seam. Three vertical creases in back; middle crease on center back line; side back creases spaced equally from center crease.

Interlining: Top center to be lined with a non-woven polyester interlining. Cuffs and band to be lined with H'Press interlining, collar with Ck331 and flaps with EZ Crease.

UPC Identification:

A printed UPC bar code tag must be attached to every garment so as to be visible in the package. The UPC bar code must identify style, color and size information so as to be incorporated into an inventory management system. Appropriate support documentation must be available to assist Agency in encoding UPC information.

Labels: Woven brand label to be sewn in yoke, with size label sewn next to it. Care and content label to be sewn in bottom hem.

Button: All buttons shall be made from high impact melamine and must match fabric.

Embroidery: All shirts will have Galveston Co. Sheriff's Office badge embroidered over left chest and deputies first initial and last name embroidered over right chest. Color depends on rank.

Emblems: All shirts will have Galveston Co. Sheriff's Office emblems on each sleeve.

Pressing and Packing:

Shirts shall be carefully pressed by hand in first class manner and individually packed in polyethylene bags. Shirts to be shipped in strong boxes so as not to be damaged in shipment. Shirts to be bulk packed.

ELBECO TEXTROP2
Male Long Sleeve Shirts

Code of Conduct:

All garments must be produced in acceptable non-sweatshop working conditions. Verification of acceptable working conditions will be made through a completed Code of Conduct document that must be made available to the department. This document should list the location of the manufacturing companies/facilities and address child labor, wage and benefits, overtime, forced labor, freedom of association, harassment or abuse, health and safety, hours of work, nondiscrimination, and no retaliation guidelines. Noncompliance of this clause is cause for rejection.

Finished Dimensions

<u>Size:</u>	<u>14</u>	<u>14.5</u>	<u>15</u>	<u>15.5</u>	<u>16</u>	<u>16.5</u>	<u>17</u>	<u>17.5</u>	<u>18</u>	<u>18.5</u>
Chest:	39	41	43	45	47	49	51	53	55	57
Waist:	35	37	39	41	43	45	47	50	53	55
Bk Length:	32 1/8	32 1/4	32 3/8	32 5/8	32 3/4	33	33 1/2	34 1/2	34 5/8	35 1/2

Note: Navy shirt to be made to accommodate removable metal buttons on shoulder straps, pocket flaps and cuffs.

ELBECO TEXTROP2
Male Short Sleeve Shirts

Style: It is the intention of this department to secure a tailored shirt equal in quality of workmanship and style to the shirt now on display as a sample. Elbeco Tex-Trop brand or pre-approved equal only.

Shirts will be cut on a form-fitting line, and the shape of the pockets and general style will conform to this sample.

Tailoring: It is imperative that this garment be constructed according to the principles set forth in the specifications. All stitches must be of the proper tension and size so as to avoid puckering after the shirt has been laundered and to give best durable press performance. All sewing shall be with Dacron core thread to match shirt fabric.

The collar is to be single stitched 1/4" from edge. The pockets and flaps shall be single stitched on the edge.

Fabric: To insure permanent moisture control, superior breathability, soil resistance, easy care, wrinkle resistance, color matching, and color retention, the fabric is to be Burlington 100% texturized polyester plain weave with mechanical stretch, weighing 5.5 oz./sq. yd., 10 oz./lin. yd. Nano Moisture Wicking technology is applied at the fiber level to capture and pull fluids and perspiration away from the skin and spread it over the fabric surface for quick evaporation to keep the wearer dry and comfortable.

Creasing: Pockets and pocket flaps to be die creased to give uniform shape and size.

Collar: Convertible collar shall be one piece and to measure 3-1/4" long at points and 1-5/8" wide at back. The collar is to be constructed of two plies of basic material and one ply of D331 top fuse lining.

The collar and inner yoke to be lined with matching 65% Dacron Polyester/35% Cotton, 4.2 ounce per square yard, 106 x 58. The collar lining shall be banana shaped.

Collar stays shall be of good quality Stalar vinyl, 2-3/4" in length and 3/8" wide and be attached to the bottom collar.

Sleeves: To be straight and whole with 1" hem. These shall be graded in length so as to finish from the shoulder seam as follows:

<u>Size</u>	<u>Finished Length</u>
14 and 14-1/2	9-1/2"
15, 15-1/2, and 16	10"
16-1/2 and above	10-1/2"

ELBECO TEXTROP2
Male Short Sleeve Shirts

The sleeves must be secured to the body of the shirt by means of a merrow stitch with a safety stitch so as to properly strengthen the stitch. The same stitch must be used on the side closing seams as well.

Flex Vent: Patent pending Flex Vent is made from 92% polyester/8% spandex mesh. Diamond shaped mesh measuring 3 ¼" wide x 10 ¼" long is set into the sleeve and body panels at the underarm to allow for body heat ventilation and increased mobility and comfort.

Front: The front shall have a facing 3" in width extending from neckline to the bottom of shirt provided by a turnunder of material. The left front shall also have a lined box pleat 1-1/2" wide finished, running full length of the shirt and shall be topstitched 1/4" from both edges.

The center front shall contain seven vertical buttonholes placed 3/4" from edge. First at neck, second 2-1/2" down, balance 3-1/2" apart.

Back: There is to be yoke composed of an outer piece of the same material as the basic shirt, and an inner piece of poplin.

Dual Comm Access Openings:

Access opening measuring 1-1/2" are to be set in each side seam 1" below the bottom tip of the Flex Vent. Pouch style openings are clean-finished, neatly concealed and reinforced for durability. These opening are used to thread communication wires under the front of the shirt to keep them out of the way.

Pockets: There are two double entry chest pockets with mitred corners to finish 5-5/8" wide and 6" long. The side entry forms a utility pocket closed with Velcro. The left chest pocket to have a pencil compartment about 1-1/4" wide. Both pockets to have 1-1/4" box pleat stitched from top to bottom to prevent spreading.

Flaps: To have two scalloped flaps to finish 5-3/4" in length, 2-3/4" in width at center, and 2-1/2" in width at sides. Flaps to be secured to front of shirt with two rows of stitching approximately 1/4" above top of pocket. The left flap to have a pencil opening about 1-1/4" in width. Flaps to be interlined. There will be a matching button and a buttonhole sewn on the flap.

Flap Closure:

The side points of the flaps are to be secured to the pockets by means of velcro fasteners sewn onto the flaps and pockets.

ELBECO TEXTROP2
Male Short Sleeve Shirts

Badge Tab: To be reinforced on inside of the shirt by means of a strip of material 1-1/2" wide stitched and folded so that no raw edges show. The reinforcement strip is to extend from the flap setting stitch to the joining seam at the front of the yoke. To have two small (horizontal) buttonholes, 1-1/4" apart with the bottom buttonhole 1-1/2" above top of left flap.

Shoulder Straps:

The shoulder straps shall be pointed at the end toward the neck of the shirt. The other end shall be sewn in sleeve head seam. The pointed ends shall be fastened with one matching button. The straps shall measure 2" at sleeve and taper to 1-3/8". Straps to be set about 2" from the collar. Shoulder straps shall be box stitched to shoulders with row of cross stitching 2" from sleeve head seam.

Permanent Creases:

Shirt to have permanent military creases. Creases to be stitched in shirt only, not thru pockets and flaps. One crease in each front extending from hem to joining seam. Three vertical creases in back; middle crease on center back line; side back creases spaced equally from center crease.

Interlining: Flaps to be EZ crease, collar to be D331. Top center to be lined with non-woven polyester interlining.

UPC Identification:

A printed UPC bar code tag must be attached to every garment so as to be visible in the package. The UPC bar code must identify style, color and size information so as to be incorporated into an inventory management system. Appropriate support documentation must be available to assist Agency in encoding UPC information.

Labels: Woven brand label to be sewn in yoke, with size label sewn next to it. Care and content label to be sewn in bottom hem.

Button: All buttons shall be made from high impact melamine and must match fabric.

Embroidery: All shirts will have Galveston Co. Sheriff's Office badge embroidered over left chest and deputies first initial and last name embroidered over right chest. Color depends on rank.

Emblems: All shirts will have Galveston Co. Sheriff's Office emblems on each sleeve.

Pressing and Packing:

Shirts shall be carefully pressed by hand in first class manner and individually packed in polyethylene bags. Shirts to be shipped in strong boxes so as not to be damaged in shipment. Shirts to be bulk packed.

**ELBECO TEXTROP2
Male Short Sleeve Shirts**

Code of Conduct:

All garments must be produced in acceptable non-sweatshop working conditions. Verification of acceptable working conditions will be made through a completed Code of Conduct document that must be made available to the department. This document should list the location of the manufacturing companies/facilities and address child labor, wage and benefits, overtime, forced labor, freedom of association, harassment or abuse, health and safety, hours of work, nondiscrimination, and no retaliation guidelines. Noncompliance of this clause is cause for rejection.

Finished Dimensions

<u>Size:</u>	<u>14</u>	<u>14.5</u>	<u>15</u>	<u>15.5</u>	<u>16</u>	<u>16.5</u>	<u>17</u>	<u>17.5</u>	<u>18</u>	<u>18.5</u>
Chest:	39	41	43	45	47	49	51	53	55	57
Waist:	35	37	39	41	43	45	47	50	53	55
Bk Length:	32 1/8	32 1/4	32 3/8	32 5/8	32 3/4	33	33 1/2	34 1/2	34 5/8	35 1/2

Note: Navy shirt to be made to accommodate removable metal buttons throughout.

November 4, 2013

Page 4 of 4

ELBECO TEXTROP2
Female Long Sleeve Ladies Choice Shirts

Style: It is the intention of this department to secure a tailored shirt equal in quality of workmanship and style to the shirt now on display as a sample. Elbeco Tex Trop brand or pre-approved equal only.

Shirts will be cut in the Ladies Choice pattern with expanded chest, waist and hip dimensions for a more flattering fit.

Tailoring: It is imperative that this garment be constructed according to the principles set forth in the specifications. All stitches must be of the proper tension and size so as to avoid puckering after the shirt has been laundered and to give best durable press performance. All sewing shall be with Dacron core thread to match shirt fabric.

The collar and cuffs are to be single stitched 1/4" from edge. The pockets and flaps shall be single stitched on the edge.

Fabric: To insure permanent moisture control, superior breathability, soil resistance, easy care, wrinkle resistance, color matching, and color retention, the fabric is to be Burlington 100% texturized polyester plain weave with mechanical stretch, weighing 5.5 oz./sq. yd., 10 oz./lin. yd. Nano Moisture Wicking technology is applied at the fiber level to capture and pull fluids and perspiration away from the skin and spread it over the fabric surface for quick evaporation to keep the wearer dry and comfortable.

Creasing: Pockets and pocket flaps to be die creased to give uniform shape and size.

Collar: The shape and style of both leaf and stand shall conform to the TT89 banded collar. The points, medium spread, are to be approximately 3" in length. The back of the stand is to measure 1-1/2". The leaf shall be made of three pieces; two pieces of self cloth and one whole lining, which is to be fused to the top collar.

Innerstand and inner yoke to be made of matching 65% Dacron Polyester/35% Cotton, 4.2 ounce per square yard, 106 x 58.

Collar stays shall be of good quality Stalar vinyl, 2-1/2" in length and 3/8" wide and be attached to the bottom collar. The stand shall fasten with one button. There shall be one horizontal button hole.

Sleeves: To be straight and whole. The cuffs are to be 2-5/8" in width and to fasten with a two button adjustable cuff. There is to be a single stitch 7/16" from top of cuff.

ELBECO TEXTROP2
Female Long Sleeve Ladies Choice Shirts

The sleeve opening shall measure 3-7/8" from top of cuff. The top facing for this opening is to be 1-1/4" wide and the bottom facing to finish about 2" wide. Button is to be placed on sleeve opening with corresponding buttonhole.

The sleeves must be secured to the body of the shirt by means of a merrow stitch with a safety stitch so as to properly strengthen the stitch. The same stitch must be used on the side closing seams as well.

Flex Vent: Patent pending Flex Vent is made from 92% polyester/8% spandex mesh. Diamond shaped mesh measuring 3 1/4" wide x 10 1/4" long is set into the sleeve and body panels at the underarm to allow for body heat ventilation and increased mobility and comfort.

Front: The front shall have a center facing 1-1/2" wide extending from the collar stand to bottom of shirt and be made of the same material as shirt fabric with two rows of stitching 7/8" apart.

The center front shall contain six vertical buttonholes placed 3/4" from edge and 3-1/2" apart. Buttons shall be securely attached to the left front and shall correspond to the buttonholes on the right front.

Back: There is to be yoke composed of an outer piece of the same material as the basic shirt, and an inner piece of poplin.

Dual Comm Access Openings:

Access opening measuring 1-1/2" are to be set in each side seam 1" below the bottom tip of the Flex Vent. Pouch style openings are clean-finished, neatly concealed and reinforced for durability. These opening are used to thread communication wires under the front of the shirt to keep them out of the way.

Pockets: There are two double entry chest pockets with mitred corners to finish 5" wide and 5-1/2" long. The side entry forms a utility pocket closed with Velcro. The left chest pocket to have a pencil compartment about 1-1/4" wide. Both pockets to have 1-1/4" box stitching top and bottom to prevent spreading.

Flaps: To have two scalloped flaps to finish 5-1/4" in length, 2-3/8" in width at center, and 2-1/8" in width at sides. Flaps to be secured to front of shirt with two rows of stitching approximately 1/4" above top of pocket. The left flap to have a pencil opening about 1-1/4" in width. Flaps to be interlined. There will be a matching button and a buttonhole sewn on the flap.

Female Long Sleeve

Ladies Choice Shirts

Flap Closure:

The side points of the flaps are to be secured to the pockets by means of velcro fasteners sewn onto the flaps and pockets.

Badge Tab: To be reinforced on inside of the shirt by means of a strip of material 1-1/2" wide stitched and folded so that no raw edges show. The reinforcement strip is to extend from the flap setting stitch to the joining seam at the front of the yoke. To have two small (horizontal) buttonholes, 1-1/4" apart with the bottom buttonhole 1-1/2" above top of left flap.

Shoulder Straps:

The shoulder straps shall be pointed at the end toward the neck of the shirt. The other end shall be sewn in sleeve head seam. The pointed ends shall be fastened with one matching button. The straps shall measure 2" at sleeve and taper to 1-3/8". Straps to be set about 2" from the collar. Shoulder straps shall be box stitched to shoulders with row of cross stitching 2" from sleeve head seam.

Permanent Creases:

Shirt to have permanent military creases. Creases to be stitched in shirt only, not thru pockets and flaps. One crease in each front extending from hem to joining seam. Three vertical creases in back; middle crease on center back line; side back creases spaced equally from center crease.

Interlining: Top center to be lined with a non-woven polyester interlining. Cuffs and band to be lined with H'Press interlining, collar with Ck331 and flaps with EZ Crease.

UPC Identification:

A printed UPC bar code tag must be attached to every garment so as to be visible in the package. The UPC bar code must identify style, color and size information so as to be incorporated into an inventory management system. Appropriate support documentation must be available to assist Agency in encoding UPC information.

Labels: Woven brand label to be sewn in yoke, with size label sewn next to it. Care and content label to be sewn in bottom hem.

Button: All buttons shall be made from high impact melamine and must match fabric.

Embroidery: All shirt will have Galveston Co. Sheriff's Office badge embroidered over left

chest and deputies first initial and last name embroidered over right chest. Color depends on rank.

Emblems: All shirts will have Galveston Co. Sheriff's Office emblems on each sleeve.

Pressing and Packing:

Shirts shall be carefully pressed by hand in first class manner and individually packed in polyethylene bags. Shirts to be shipped in strong boxes so as not to be damaged in shipment. Shirts to be bulk packed.

ELBECO TEXTROP2
Female Long Sleeve Ladies Choice Shirts

Code of Conduct:

All garments must be produced in acceptable non-sweatshop working conditions. Verification of acceptable working conditions will be made through a completed Code of Conduct document that must be made available to the department. This document should list the location of the manufacturing companies/facilities and address child labor, wage and benefits, overtime, forced labor, freedom of association, harassment or abuse, health and safety, hours of work, nondiscrimination, and no retaliation guidelines. Noncompliance of this clause is cause for rejection.

Finished Dimensions

<u>Size:</u>	<u>30</u>	<u>32</u>	<u>34</u>	<u>36</u>	<u>38</u>	<u>40</u>	<u>42</u>	<u>44</u>	<u>46</u>	<u>48</u>
Bust:	39-3/8	40-3/8	41-7/8	43-3/8	44-7/8	46-5/8	48-3/8	50-3/8	52-3/8	54-3/8
Waist:	36½	37½	39	40½	42	43½	45½	47½	49½	51½
Back:	27½	27½	28½	28½	28½	28½	28½	28½	29	29
Sleeve Length:	30	30	31	32	32	33	33	33	34	34

Note: Navy shirt to be made to accommodate removable metal buttons on shoulder straps, pocket flaps and cuffs.

ELBECO TEXTROP2
Female Short Sleeve Ladies Choice Shirts

Style: It is the intention of this department to secure a tailored shirt equal in quality of workmanship and style to the shirt now on display as a sample. Elbeco Tex-Trop brand or pre-approved equal only.

Shirts will be cut in the Ladies Choice pattern with expanded chest, waist and hip dimensions for a more flattering fit.

Tailoring: It is imperative that this garment be constructed according to the principles set forth in the specifications. All stitches must be of the proper tension and size so as to avoid puckering after the shirt has been laundered and to give best durable press performance.

All sewing shall be with Dacron core thread to match shirt fabric. The collar is to be single stitched 1/4" from edge. The pockets and flaps shall be single stitched on the edge.

Fabric: To insure permanent moisture control, superior breathability, soil resistance, easy care, wrinkle resistance, color matching, and color retention, the fabric is to be Burlington 100% texturized polyester plain weave with mechanical stretch, weighing 5.5 oz./sq. yd., 10 oz./lin. yd. Nano Moisture Wicking technology is applied at the fiber level to capture and pull fluids and perspiration away from the skin and spread it over the fabric surface for quick evaporation to keep the wearer dry and comfortable.

Creasing: Pockets and pocket flaps to be die creased to give uniform shape and size.

Collar: Convertible collar shall be one piece and to measure 3-1/8" long at the points and 1-5/8" wide at back. The collar is to be constructed of two plies of basic material and one ply of D331 top fuse lining.

The collar and inner yoke to be lined with matching 65% Dacron Polyester/35% Cotton, 4.2 ounce per square yard, 106 x 58. The collar lining shall be banana shaped.

Collar stays shall be of good quality Stalar vinyl, 2-3/4" in length and 3/8" wide and be attached to the bottom collar.

Sleeves: To be straight and whole with 1" hem. The finish shall be 9-1/2" long from shoulder seam.

ELBECO TEXTROP2
Female Short Sleeve Ladies Choice Shirts

The sleeves must be secured to the body of the shirt by means of a merrow stitch with a safety stitch so as to properly strengthen the stitch. The same stitch must be used on the side closing seams as well.

Flex Vent: Patent pending Flex Vent is made from 92% polyester/8% spandex mesh. Diamond shaped mesh measuring 3 1/4" wide x 10 1/4" long is set into the sleeve and body panels at the underarm to allow for body heat ventilation and increased mobility and comfort.

Front: The fronts shall have a center facing 3" in width extending from neckline to bottom of shirt provided by a turnunder of material. The right front shall also have a lined box pleat 1-1/2" wide finished, running full length of the shirt and shall be topstitched 1/4" from both edges.

The center front shall contain seven vertical buttonholes placed 3/4" from edge, first at neck, second 2-1/2" down, balance 3-1/2" apart.

Back: There is to be yoke composed of an outer piece of the same material as the basic shirt, and an inner piece of poplin.

Dual Comm Access Openings:

Access opening measuring 1-1/2" are to be set in each side seam 1" below the bottom tip of the Flex Vent. Pouch style openings are clean-finished, neatly concealed and reinforced for durability. These opening are used to thread communication wires under the front of the shirt to keep them out of the way.

Pockets: There are two double entry chest pockets with mitred corners to finish 5" wide and 5-1/2" long. The side entry forms a utility pocket closed with Velcro. The left chest pocket to have a pencil compartment about 1-1/4" wide. Both pockets to have 1-1/4" box stitching top and bottom to prevent spreading.

Flaps: To have two scalloped flaps to finish 5-1/4" in length, 2-3/8" in width at center, and 2-1/8" in width at sides. Flaps to be secured to front of shirt with two rows of stitching approximately 1/4" above top of pocket. The left flap to have a pencil opening about 1-1/4" in width. Flaps to be interlined. There will be a matching button and a buttonhole sewn on the flap.

Flap Closure:

The side points of the flaps are to be secured to the pockets by means of velcro fasteners sewn onto the flaps and pockets.

ELBECO TEXTROP2
Female Short Sleeve Ladies Choice Shirts

Badge Tab: To be reinforced on inside of the shirt by means of a strip of material 1-1/2" wide stitched and folded so that no raw edges show. The reinforcement strip is to extend from the flap setting stitch to the joining seam at the front of the yoke. To have two small (horizontal) buttonholes, 1-1/4" apart with the bottom buttonhole 1-1/2" above top of left flap.

Shoulder Straps:

The shoulder straps shall be pointed at the end toward the neck of the shirt. The other end shall be sewn in sleeve head seam. The pointed ends shall be fastened with one matching button. The straps shall measure 2" at sleeve and taper to 1-3/8". Straps to be set about 2" from the collar. Shoulder straps shall be box stitched to shoulders with row of cross stitching 2" from sleeve head seam.

Permanent Creases:

Shirt to have permanent military creases. Creases to be stitched in shirt only, not thru pockets and flaps. One crease in each front extending from hem to joining seam. Three vertical creases in back; middle crease on center back line; side back creases spaced equally from center crease.

Interlining: Flaps to be lined with EZ crease, collar to be D331. Top center to be lined with non-woven polyester interlining.

UPC Identification:

A printed UPC bar code tag must be attached to every garment so as to be visible in the package. The UPC bar code must identify style, color and size information so as to be incorporated into an inventory management system. Appropriate support documentation must be available to assist Agency in encoding UPC information.

Labels: Woven brand label to be sewn in yoke, with size label sewn next to it. Care and content label to be sewn in bottom hem.

Button: All buttons shall be made from high impact melamine and must match fabric.

Embroidery: All shirts will have Galveston Co. Sheriff's Office badge embroidered over left chest and deputies first initial and last name embroidered over right chest. Color depends on rank.

Emblems: All shirts will have Galveston Co. Sheriff's Office emblems on each sleeve.

Pressing and Packing:

Shirts shall be carefully pressed by hand in first class manner and individually

packed in polyethylene bags. Shirts to be shipped in strong boxes so as not to be damaged in shipment. Shirts to be bulk packed.

ELBECO TEXTROP2
Female Short Sleeve Ladies Choice Shirts

Code of Conduct:

All garments must be produced in acceptable non-sweatshop working conditions. Verification of acceptable working conditions will be made through a completed Code of Conduct document that must be made available to the department. This document should list the location of the manufacturing companies/facilities and address child labor, wage and benefits, overtime, forced labor, freedom of association, harassment or abuse, health and safety, hours of work, nondiscrimination, and no retaliation guidelines. Noncompliance of this clause is cause for rejection.

Finished Dimensions

<u>Size:</u>	<u>30</u>	<u>32</u>	<u>34</u>	<u>36</u>	<u>38</u>	<u>40</u>	<u>42</u>	<u>44</u>	<u>46</u>	<u>48</u>
Bust:	39-3/8	40-3/8	41-7/8	43-3/8	44-7/8	46-5/8	48-3/8	50-3/8	52-3/8	54-3/8
Waist:	36½	37½	39	40½	42	43½	45½	47½	49½	51½
Back:	27½	27½	28½	28½	28½	28½	28½	28½	29	29

Note: Navy shirt to be made to accommodate removable metal buttons throughout.

Jailer Pants – Men's and Ladies

5.11 Specs.

74273-162 –

- Lightweight, breathable, comfortable
- Ideal for hunting, hiking, and outdoor activities
- Seven pocket configuration
- Signature 5.11 strap and slash rear pockets
- Teflon treatment for stain, soil, and spill resistance
- Action waistband
- Full gusseted crotch
- Hip-mounted D-ring holds keys or ID
- 6.14 oz. Taclite poly/cotton ripstop fabric
- 48 individual bartacks in high stress areas
- Double thick seat and knees (kneepad ready)
- Triple-stitch reinforcement
- Draw cord openings at bottom hem
- YKK® zippers
- Prym® snaps
-

64360-162

- Lightweight, breathable, comfortable
 - Ideal for hunting, hiking, and outdoor activities
 - Seven pocket configuration
 - Signature 5.11 strap and slash rear pockets
 - Teflon treatment for stain, soil, and spill resistance
 - Action waistband
 - Full gusseted crotch
 - Hip-mounted D-ring holds keys or ID
 -
 - 6.14 oz. Taclite poly/cotton ripstop fabric
 - 48 individual bartacks in high stress areas
 - Double thick seat and knees (kneepad ready)
 - Triple-stitch reinforcement
 - Draw cord openings at bottom hem
 - YKK® zippers
 - Prym® snaps
-

**SPECIFICATION FOR THE
TYPHOON RAIN COAT
STYLE 70F3/L
General Design**

The rain coat reverses from black to lime-yellow. Constructed waterproof weather system based upon two layers of waterproof fabrics, Zippered and snap front closure, front interior pockets. Telescopic collar, Seamless shoulder design, adjustable cuffs, and permanent badge holder on each side, zippered side vents and microphone tabs. 3M SCOTCHLITE, 2" silver tape w/1/4" black edges, sewn and that meets class III of the highest ANSI/ISEA 107:2010 standard. Reference product is Gerber's identification number **70F3/L TYPHOON RAIN COAT**. Color in Black reverses to Lime-yellow.

I. FABRIC/MATERIALS

- Shell Fabric:** Nylon Mid Weight Taslan, 228 T. Waterproof / Windproof / Breathable
Thread Count: Warp 158 x Fill 70
158 Denier x 70 Denier
Waterproof: ASTM D 781-2000 > 200 psi
Breathable: WVT G/sq. m ASTM E 96 > 1000 mullens
- Lining Fabric:** A two layer fabric comprised of 100% polyester, 150 Denier in the warp and the filling, plain weave
Thread Count: Warp 72 pics, Filling 62 (+-5%)
Weight Coated: 4.5 ounces per square yard (+-4%)
Tear Strength: ASTM D226 Warp and Filling 10.8 foot pounds
Breaking Strength: ASTM D5034 Warp 205 foot pounds, Filling 170 ft. lbs.
Thickness: 0.24 mm.
Visibility: ANSI 107 Compliant Lime Yellow
- Zippers:** Front zipper, #5, Delrin, YKK, with reversible slider.
- Snaps:** The snaps shall be universal prong snaps that have been oxidized to prevent rusting,
- Eyelets:** Black, metal, small.
- Seam seal tape:** Composite seam sealing tape that is compatible to the composite fabric, 7/8" wide.
- Velcro:** Black, 1" wide hook and loop.
- Reflective Tape:** 3M SCOTCHLITE, 8906, 2-1/2 wide with 2" silver tape centered over black ribbon, sewn on application.
- Thread:** All thread shall be polyester thread with a wrap with 36 strength in a 50 size or better.

II. DESIGN FEATURES

FRONT: There shall be six large snap fasteners set evenly and hidden, there shall be a reversible front zipper. The snap fasteners will be set approximately 6-1/2" apart, except the top snap will be set 1" from the placket edge. The bottom hem of the coat shall be approximately 3/4" wide. There shall a microphone tabs set on the black and lime side and shall measure 1" by 2-1/4".

There shall be a badge holder on the upper breast on the black and lime side. The badge holder shall measure 1" by 2-1/4". The eyelets shall be set 1-1/8" apart, center to center.

POCKETS: The pocket opening shall measure approximately 10" with a depth of 7". The pocket welts shall measure 2" wide by 11" long.

COLLAR: The collar shall be a telescopic design, measures 4-1/4" at the points and at the center back. There shall be three large snaps (male portion) set on both sides of the collar to anchor the detachable hood.

DROP IN HOOD: There shall be concealable hood that folds inside out into the zippered opening on the under collar. The outside shell and interior lining shall be constructed from outer shell fabric. The hood shall have a three panel design for a contoured ergonomic fit and feature wrap around storm collar with hook and loop closure. It also shall have an elasticized draw cord that runs around the perimeter of the face opening and barrel clip adjusters.

BACK DESIGN: The back shall be a full cut, raglan design.

SLEEVES: Sleeves shall be a raglan design for freedom of movement.

ADJUSTABLE CUFFS: The adjustable cuffs shall measure approximately 2" wide and shall have an adjustment tab that measures 1" wide and 2-1/2" long. There shall be a 1" x 2" Velcro hook set on the tab and will attached to a 1" x 5" Velcro loop set on the cuff for a full range of adjustments from full cuff to snug wrist fit. Half of the cuffs shall be 2" heavy-duty elastic stretched and sewn with double needle. The top half of the cuffs shall be plain and interlined.

SIDE VENTS: There shall be side vent opening on both side to allow for equipment access

FACINGS: On the fluorescent lime side there shall be facings made out of the outer shell fabric. The facings shall measure approximately 1-1/4" and set on the fronts. Also there shall be upper front facings that measure 3-1/2" at the widest and tapers to a point.

REFLECTIVE TRIM: On the fluorescent lime side there shall be a 2-1/2" wide trim with 2" silver tape set centered over black ribbon. The trim shall be sewn across the chest and back, and a stripe on the upper sleeves which will align with the chest and back stripes, there shall be a second stripe sewn about 4" from the sleeve edge.

SEAM SEALING: All external seams and sewing are to be seam sealed with a 7/8" wide seam sealing tape that is set with a hot air seam sealing machine. Seams are to be randomly tested with a suttor tester 3 psi for 3 minutes. A log shall be maintained to record the testing results.

IMPRINTS: SHERIFF will be printed on both black and green backs in silver reflective lettering.

LABELS: Each garment shall have a brand label and an ANSI label with care instructions, the ID number and the size of the garment.

HANGTAGS: Each garment shall have a GERBER and a 3M SCOTCHLITE hangtag. On the back side of the GERBER hangtag there shall be a sticker label with the style name, the ID# and the size of the garment.

GUARANTEE: Each garment shall be guaranteed to be free from defects and the factory workmanship shall be guaranteed for five years. This guarantee shall be evidenced by a hangtag on each garment.

SILENCE OF SPECIFICATION: The apparent silence of this specification as to any details or the omission from it of a detail description concerning any point shall be interpreted as meaning that only the best commercial practices are to prevail and only materials and workmanship of first quality to be used.

III. MEASUREMENTS

SIZING: The manufacturer shall be capable of providing all sizes for men and women, including any special size requirements. The manufacturer shall have a company representative or authorized dealer available to assist with the fittings of the garments at no additional cost.

The following sizes have been established as a guideline for this order:

SIZE CHART

SIZE	FINISHED CHEST	BACK LENGTH	SLEEVE INSEAM
X-SMALL (32-34)	46	48	21-1/2
SMALL (36-38)	50	48	21-1/2
MEDIUM (40-42)	54	48	21-1/2
LARGE (44-46)	58	48	21-1/2
X-LARGE (48-50)	62	48	21-1/2
XX-LARGE (52-54)	66	48	21-1/2
XXX-LARGE (56-58)	70	48	21-1/2
XXXX-LARGE (56-58)	74	48	21-1/2
TOLERANCES	+1"	+1"	+1/2"
LONG LENGTHS	+1"	+1"	+1"
X-LONG LENGTHS	+1"	+2"	+2"

**SPECIFICATION FOR THE
PRO DRY REVERSIBLE RAINCOAT**
General Design

Full length ultra-lightweight raincoat that is reversible from black to fluorescent lime-yellow with Raglan shoulder design sleeves, front storm placket with snap closure, slash-through side openings, regular shirt style collar, adjustable cuffs and a badge holder on dark side. Plain hem the on bottom. ANSI/ISEA 107:2010 standard construction with 2-1/2" retro-reflective tape with 2" silver centered on the tape with black 1/4" printed on the edges. Reference product is Gerber's Identification number **70C3/L PRO DRY REVERSIBLE RAINCOAT BLACK & LIME**.

I. FABRIC/MATERIALS

Outer Shell: A multi-layer fabric comprised of 100% nylon, 70 Denier in the warp and the filling, plain weave and a pigmented back coating that can be seam sealed and provide waterproofness and breathability.

Thread Count:	Warp 175 pics, Filling 125 (+-5%)
Weight Coated:	6.1 ounces per square yard (+-4%)
Tear Strength:	ASTM D226 Warp and Filling 10.8 foot pounds
Breaking Strength:	ASTM D5034 Warp 205 foot pounds, Filling 170 ft. lbs.
Thickness:	0.24 mm.

Snaps: Oxidized snaps, gypsy style for reversibility, 24 Ligne.

Eyelets: Black, small.

Reflection Tape: 2-1/2" retro-reflective tape with 2" silver centered on the tape with black 1/4" printed on the edges.

Seam Tape: Composite seam sealing tape that is compatible to the composite fabric, 7/8" wide.

Velcro: Black, 1" wide hook and loop

Elastic: Black, 1" wide dry cleanable and washable.

Thread: All thread shall be polyester thread with a wrap with 36 strength in a 50 size or better.

Garment Bag: Plastic.

II. DESIGN FEATURES

FRONT: There shall be double placket storm fronts with six oxidized, gypsy snaps for closure. The front double plackets shall measure 2-1/2" wide and run the entire length of the raincoat. There shall be a permanent badge holder set to the left breast on the black side of the raincoat and shall be made out of the shell fabric with two small black metal eyelets that are spaced 1-1/8" apart. There shall be an ANSI -107 label set on either side of the top placket near the bottom hem on the black side.

The badge holder is to measure 1" by 2-1/4" and shall be set 7" down from the shoulder seam on all sizes.

SIDE OPENINGS: There shall be two welted slash-through side openings measuring 11-1/2" long set in the side seams for access to equipment, weapons, or trouser pockets. These shall be covered with welts on the dark side measuring 1-1/2" wide by 12" long with a strip of hook and loop velcro fastener 5/8" wide by 4" long centered under the flap.

COLLAR: The shell fabric collar shall measure 3-1/2" at the points and 3-3/4" at the center. Collar to be black on both sides and to be constructed so that the collar to the back seam can be properly seam sealed.

SLEEVES: The sleeves are to be a one-piece raglan style design.

ADJUSTABLE CUFFS: There shall be a one-piece cuff design made out of self-material that shall measure 2" wide. Half of the cuffs shall be heavy duty elastic stretched with 1-1/2" elastic and sewn with double needle. There shall be cuff tabs that measure 1-1/2" wide and taper to 1" wide, and shall be 3-1/2" long with a Velcro hook set at the tapered end that shall attach to the Velcro loop set on the cuff for adjustments.

REFLECTION TAPE: On the lime-yellow side of the raincoat there is to be two stripes, of the retro-reflective tape, heat-set on the body and on both sleeves. The positioning of the top body stripe is to be 1-1/2" below the armhole. The top stripe on the sleeves shall be aligned to the top body stripe. The lower body stripe is to be aligned to the lower stripe on the sleeves which should be placed **no less than 2"** from the finished hem.

SEAM SEALING: All external seams and sewing are to be seam sealed with a 7/8" wide seam sealing tape that is set with a hot air seam sealing machine. Seams are to be randomly tested with a sutor tester 3 psi for 3 minutes. A log shall be maintained to record the testing results.

IMPRINTS: **SHERIFF** will be printed on both black and green backs in silver reflective lettering.

LABELS: There shall be a permanent brand label, an ANSI-107-2010 label with care instructions, Identification number, size, and country of origin placed on the inner side bottom of the black front placket. The labels shall be placed between the hem and the first snap from the bottom of the placket. On the black side of either side of the top placket near the bottom hem shall be an ANSI-107 label.

HANGTAGS: Each garment shall have a GERBER hangtag. On the back side of the hangtag there shall be a sticker label with the style name, the ID# and the size of the garment.

GUARANTEE: Each garment shall be guaranteed to be free from defects. Factory workmanship and components shall be evidenced with a hangtag.

SILENCE OF SPECIFICATION: The apparent silence of this specification as to any details or the omission from it of a detail description concerning any point shall be interpreted as meaning that only the best commercial practices are to prevail and the materials and workmanship of first quality to be used.

70C3/L PRO DRY REVERSIBLE RAINCOAT**III. MEASUREMENTS**

SIZING: The manufacturer shall be capable of providing all sizes for men and women, including special size requirements. The manufacturer shall have a company representative or authorized dealer/distributor available to assist with the fittings of the garments at no additional charge.

IV. SIZE GUIDELINE**SIZE CHART**

<i>SIZE</i>	<i>FINISHED CHEST</i>	<i>BACK LENGTH</i>	<i>SWEEP</i>	<i>SLEEVE INSEAM</i>
X-SMALL	46	49	51	22
SMALL (36-38)	50	49	55	22
MEDIUM (40-42)	54	49	59	22
LARGE (44-46)	58	49	63	22
X-LARGE (48-50)	62	49	67	22
XX-LARGE (52-54)	66	49	71	22
XXX-LARGE (56-58)	70	49	75	22
XXXX-LARGE (60-62)	74	49	79	22

PRO DRY RAINCOAT, REVERSIBLE

JUNE 17, 2008

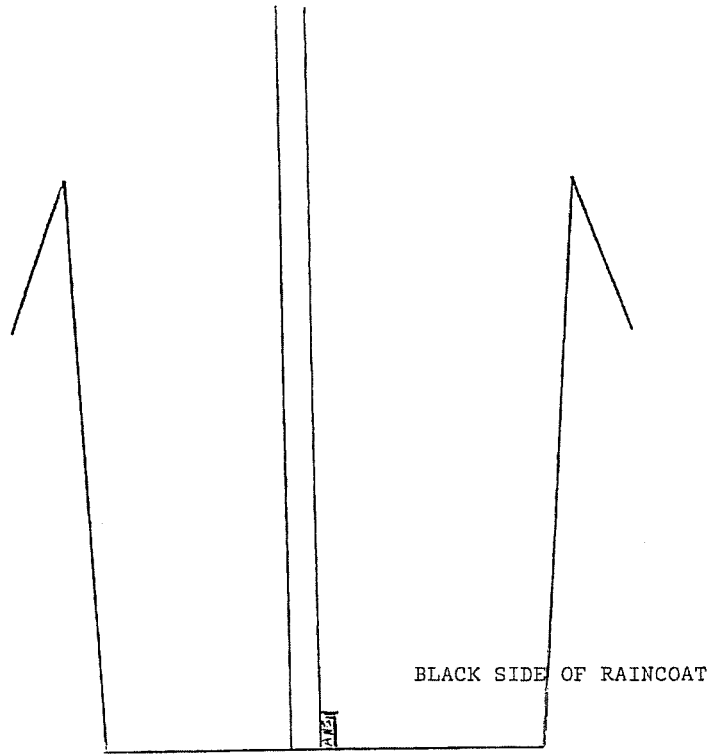

NOTE: DRAWING NOT TO SCALE

ANSI 107 LABEL
CAN BE PLACED ON
EITHER SIDE OF PLACKET
(BLACK SIDE OF RAINCOAT)



Terry L. Gerber



Research and Development
Bid Specifications

441024

Alpha Elite Series NIJ.06 Level IIIA
With Two Hi-Lite Carriers (HL6/HX6)

Revision: 06/26/2015

1. Scope

This product specification details the style and quality of Level IIIA concealable or tactical vests intended for use by male or female members of this agency. The vests shall be worn comfortably while being concealed under a shirt or in tactical applications. All vests shall provide protection against labeled projectile penetration while reducing resultant blunt trauma, and vest distortion to acceptable levels. The successful vendor shall be required to supply the individual vests with applicable options and colors as ordered for male or female personnel.

The concealable or tactical body armor shall be the Point Blank Enterprises Models AXIIIA and AXIIIAF for NIJ-0101.06 for Threat Level IIIA. Bids based on body armor models made by manufacturers other than Point Blank Enterprises must be clearly identified as such, and bidders must include full product description, a complete bid sample (male and female), drawings, photographs, and/or technical specifications.

Where the apparent low bidder has proposed an alternate product, that bidder shall demonstrate product equivalency to the satisfaction of the department. Evidence of equivalency shall be presented for each requirement of this specification, and the burden of such equivalency is entirely on the vendor. Any bidder may be required, at any time during the procurement process, to provide documentation proving compliance with any or all the terms of this specification.

Only body armor models, which have been tested by the National Institute of Justice (NIJ) National Law Enforcement & Corrections Technology Center (NLECTC), and found to comply with NIJ-Standard-0101.06 Ballistic Resistance of Body Armor for Type IIIA armor, shall be submitted under this specification. No exceptions.

Bids with multiple models, as alternates will be rejected.



Research and Development

Bid Specifications

441024

2. Two Hi-Lite™ Carriers – Each carrier has the following features:

- 2.1. Exterior fabric – Microfiber, 100% Polyester (Durable Water Repellent)
- 2.2. Exterior color options - Navy (BEB), Black (BKA), Tan (TNA), and White (WHA)
- 2.3. Interior fabric - Dri-Lex® Bandelero – Moisture Management System
- 2.4. Interior color is the same as exterior except for the following colors:
 - 2.4.1. Navy Blue with Black interior
 - 2.4.2. Tan with White interior
- 2.5. Trauma insert pockets accommodate Speed and Soft Trauma Plate sizes 5"x8", 6"x8", 7"x9", 8"x10"
- 2.6. One - 5" x 8" trauma plate (option of soft or steel)
- 2.7. Two 2" x 7" Breath-O-Prene® Shoulder Straps (for males)
- 2.8. Two 2" x 5" Breath-O-Prene® Shoulder Straps (for females)
- 2.9. Four 2" x 12" elastic Side Straps (for males). Four 2"x8" elastic Side Straps (for females)
- 2.10. For males - One elastic Cumberbund - 4" x 19" for sizes up to 48 and 4" x 27" for sizes 50 and up
- 2.11. For females - One elastic Cumberbund - 3" x 13.5" for SM1, SM, MD, and 4"x19" for sizes LG and up
- 2.12. Internal Zipper Closure (hidden zipper slide)
- 2.13. Velcro® Brand Fastener (low profile) used for side strap attachment points
- 2.14. Adjustable Side Straps offer 8-point adjustability
- 2.15. Male - Narrow split front tail design provides a secure, less bulky fit (tail/no tail options)
- 2.16. Female- Narrow cut skirt tail construction in front and rear for a secure, less bulky fit (tail/no tail options)

3. HiLite™ Carrier - Optional System Features

- 3.1. Concealable kit: two carriers, one ballistic (front and back), and one soft trauma plate
- 3.2. Concealable complete set: one carrier, one ballistic (front and back), and one soft trauma plate
- 3.3. Additional Microfiber Carrier
- 3.4. Blade Plates and Trauma Insert Plates
- 3.5. For males 2" x 12" Removable Side Straps. For females 2"x8" Removable Side Straps
- 3.6. Elastic Removable Cumberbund
- 3.7. R20-D Accessory Carrier as a tactical option for the concealable ballistics
- 3.8. Tail/No Tail
- 3.9. Optional ThorShield™ adds protection against Taser® or electroshock weapons

Research and Development Bid Specifications

441024

4. Ballistics

4.1. NIJ Certification Data:

Level IIIA - AXIII A weight is 0.87 pounds per square foot. Thickness is 0.20 inches.

Level IIIA - AXIII AF weight is 0.87 pounds per square foot. Thickness is 0.20 inches.

Threat 1 - Low Caliber

Model No.	Cert Size (C1-C5)	New 357Sig V50 (fps/mps)		Conditioned 357Sig V50 (fps/mps)		New 357Sig BFS (mm/in)		Conditioned 357Sig BFS (mm/in)		Certification Date	Berry (Yes/No)
AXIII A	C1	1870	570	1855	566	29.76	1.17	30.60	1.20	10/8/2013	Y
	C5					28.31	1.11	29.42	1.16		
AXIII AF	C1	1884	574	1882	574	31.03	1.22	27.65	1.09	07/22/2013	Y
	C5					27.77	1.09	27.70	1.09		

Threat 2 - High Caliber

Model No.	Cert Size (C1-C5)	New 44Mag V50 (fps/mps)		Conditioned 44Mag V50 (fps/mps)		New 44Mag BFS (mm/in)		Conditioned 44mag BFS (mm/in)		Certification Date	Berry (Yes/No)
AXIII A	C1	1745	532	1770	540	39.18	1.54	40.30	1.59	10/8/2013	Y
	C5					33.81	1.33	36.08	1.42		
AXIII AF	C1	1744	532	1711	522	38.88	1.53	36.38	1.43	07/22/2013	Y
	C5					35.41	1.39	33.48	1.32		

Research and Development Bid Specifications

441024

4.2. Ballistics Performance (Special Threats Testing)

4.2.1. The AXIHA has been tested in accordance with the FBI Test Protocol Version 4.1., dated 22 May 2014. Shots against the armor samples were performed at 0.0° obliquity and ambient range temperature (67 ± 1 °F). Each sample was conditioned to a specific parameter prior to testing. For each shot, the target was strapped to a gelatin block. The ballistic resistance test was performed at an NIJ independent laboratory using the following threats:

- 9-mm NATO, 124-grain full metal jacketed (FMJ) projectiles
- 9-mm-127-grain supreme expansion technology (SXT) projectiles
- 9-mm-147-grain gold dot hollow point (GDHP) projectiles
- .40-cal., 180-grain S&W Speer gold dot hollow point (GDHP) projectiles
- .45 Auto, 230-grain brass jacketed hollow point (BJHP) projectiles

Table 1. Summary of Test Results - FBI Test Protocol

Job No.	Threat	Condition	Target Obliquity (deg)	Shot No.	Penetration Data	
					Velocity (ft/s)	Result
2051-159-1	9mm NATO, 124-grain FMJ	Dry	0.0	1	1413	None
				2	1426	None
				3	1413	None
				4	1426	None
				5	1421	None
				6	1419	None
				7	1431	None
				8	1421	None
2051-159-2	9mm NATO, 124-grain FMJ	Dry	0.0	1	1435	None
				2	1445	None
				3	1429	None
				4	1423	None
				5	1435	None
				6	1415	None
				7	1438	None
				8	1437	None
2051-159-3	9mm NATO, 124-grain FMJ	Hot	0.0	1	1418	None
				2	1425	None
				3	1418	None
	.45 Auto, 230-grain BJHP		0.0	4	NA ^a	None
	9mm, 127 grain SXT		0.0	5	NA ^a	None

Research and Development

Bid Specifications

441024

Table1. Summary of Test Results - FBI Test Protocol (continued)

Job No.	Condition	Threat	Target Obliquity (deg)	Shot No.	Penetration Data	
					Velocity (ft/s)	Result
2051-159-4	Hot	9mm NATO, 124-gr. FMJ	0.0	1	1433	None
				2	1418	None
				3	1414	None
		9mm, 147-gr. GDHP	0.0	4	NA ^a	None
		.40cal., 180-gr. S&W Speer GDHP	0.0	5	NA ^a	None
2051-159-5	Cold	9mm NATO, 124gr. FMJ	0.0	1	1411	None
				2	1410	None
				3	1415	None
		.40cal., 180gr. S&W Speer GDHP	0.0	4	NA ^a	None
		9mm, 147gr. Speer GDHP	0.0	5	NA ^a	None
2051-159-6	Cold	9mm NATO, 124-gr. FMJ	0.0	1	1409	None
				2	1419	None
				3	1413	None
		.40cal., 180gr. S&W Speer GDHP	0.0	4	NA ^a	None
		9mm, 147gr. Speer GDHP	0.0	5	NA ^a	None
2051-159-7	Wet	9mm NATO, 124gr. FMJ	0.0	1	1418	None
				2	1427	None
				3	1425	None
2051-159-8	Wet	9mm NATO, 124gr. FMJ	0.0	1	1417	None
				2	1435	None
				3	1446	None

Research and Development

Bid Specifications

441024

4.2.2. National Technical Systems, Inc. (NTS) performed ballistic limit and resistance tests in accordance with NIJ-0101.06 body armor test requirements for special threats. The following is a summary of the test results:

NTS V0 Summary

NTS Record Number	Threat	Condition	Obliquity	BFD (mm)
PB13044	Wolf 9mm 115gr. Bimetal Jacket (FMJ)	New/Dry	0°	23.56
			0°	23.69
			0°	25.21
			30°	22.03
			45°	21.82
			0°	25.18
PB13045	Winchester 9mm Luger +P+ 127gr. SXT	New/Dry	0°	28.01
			0°	28.60
			0°	28.83
			45°	26.88
			30°	28.04
			0°	26.12
PB13046	FNH US 5.7x28, 27gr. SS195 L.F.	New/Dry	0°	13.65
			0°	16.44
			0°	18.15
			45°	15.39
			30°	17.92
			0°	17.06
PB13047	7.62x25mm TOKAREV 85gr. FMJ	New/Dry	0°	25.90
			0°	24.41
			0°	26.13
			30°	21.70
			45°	19.83
			0°	23.83

NTS V50 Summary

NTS Record No.	Threat	Condition	V50 (fps)
PB13048	Wolf 9mm, 115gr. Bimetal Jacket FMJ	New	1781
PB13049	Winchester 9mm Luger +P+ 127gr. SXT	New	1763



Research and Development
Bid Specifications

441024

4.2.3. National Technical Systems, Inc. (NTS) performed a special threat ballistic limit test in accordance with FQ/PD 07-05G. The following is a summary of the V50 fragmentation test results:

NTS Record Number	Projectile	Obliquity	Condition	V50 (in air)
PB13039	2gr RCC	0°	Dry	3074
PB13040	4gr RCC	0°	Dry	2721
PB13041	16gr RCC	0°	Dry	2306
PB13042	17gr FSP	0°	Dry	2114
PB13043	64gr RCC	0°	Dry	1876

4.2.4. The AXIII model has also been tested in accordance with the DEA armor testing protocol, MIL-STD-662F at Chesapeake Testing. The following is a summary of the special threat ballistic test results:

DEA V50

Sample No.	Threat	Target Obliq. (deg.)	V50 (ft/s)	No. of Points	RMR (ft/s)	GAP (ft/s)	ROR (ft/s)
2gr V50	2-grain RCC	0.0	2880	6	19	N/A	116
4gr V50	4-grain RCC	0.0	2601	6	N/A	1	98
16gr V50	16-grain RCC	0.0	2099	6	34	N/A	98
64gr V50	64-grain RCC	0.0	1772	6	N/A	58	81

Research and Development
Bid Specifications

441024

DEA V0

Sample No.	Threat	Target Obliquity	Shot No.	Velocity (ft/s)	Deformation (mm)	
Panel 1	9-mm, 124-grain FMJ	0.0	1	1448	29.2	
			2	1444	32.5	
			3	1463	29.8	
			4	1422	N/A	
			5	1447	N/A	
			6	1430	26.7	
			7	1437	34.9	
			8	1468	35.5	
			9	NR	27.3	
		9-mm, +P+ 127-grain SXT	0.0	10	NR	23.8
		.40-cal., 165-grain S+W Speer (GDHP)	0.0	11	NR	22.2
Panel 2	9-mm, 124-grain FMJ	0.0	1	1460	28.5	
			2	1441	29.3	
			3	1460	28.7	
Panel 3	9-mm, 124-grain FMJ	0.0	1	1430	28.9	
			2	1437	26.8	
			3	1442	26.2	
Panel 4	9-mm, 124-grain FMJ	0.0	1	1442	24.6	
			2	1468	27.8	
			3	1446	25.6	

4.3. Ballistic Panels - All materials are new and without flaws that affect appearance, durability, and function.

The ballistic panels are constructed of a matrix of UD Polyethylene and Woven Aramid fabrics. Self-Suspending Ballistic System™ (SSBS) provides optimal protective coverage. Each ballistic panel is covered in 100% weldable Nylon 210D double wall ripstop with TPU coating.

5. Quality and Warranty

5.1. Quality

Point Blank Enterprises, Inc. is ISO 9001-2008 Certified. ISO 9000 refers to a set of quality management standards that are recognized and respected internationally to facilitate manufacturing excellence. Point Blank Enterprises, Inc. products and services are managed, controlled, and assured by a registered ISO 9001 Quality Management System.



Research and Development

Bid Specifications

441024

5.2. Warranty

5.2.1. Warranty Card - Included with the outer shell carrier is a warranty registration card that must be completed and returned to the manufacturer's address posted on the card for the warranty to be effective.

5.2.2. Warranty – Outer Shell Carrier - The outer shell carrier and other non-ballistic components are warranted to be free from material and manufacturing defects for 24 months from the date of issue to the individual user, as verified by the warranty card. During the warranty period, any garment having a manufacturing or material defect, as determined through inspection by an authorized Point Blank Enterprises representative, will be repaired or replaced at no cost to the customer. The outer shell carrier warranty shall be void if the product has been altered, abused, misused, stored improperly, or not cleaned in accordance with cleaning instructions.

5.2.3. Warranty - Soft Ballistic Component

The bullet/stab-resistant elements are warranted to perform to their NIJ-certified standard for a period of five years from the date of issue to the individual user, as verified by the warranty card.

The bullet/stab-resistant elements of this system have been tested and certified by the National Institute of Justice and passed the compliance requirements of the NIJ Standard for Ballistic Resistance of Personal Body Armor.

The ballistic elements are warranted to be of the same construction and design as the original NIJ certified model listed on the label. During the warranty period, any soft ballistic component having a manufacturing or material defect, as determined through inspection by an authorized Point Blank Enterprises representative, will be repaired or replaced at no cost to the customer.

Should the soft body armor ballistic panel cover be compromised (cut, torn or frayed); it should not be worn and immediately returned to the manufacturer for inspection and repair. If the damage is the result of normal wear and tear, the damage will be repaired free of charge. If however, the damage is the result of improper care, storage, or abuse, determined solely by Point Blank Enterprises, then Point Blank Enterprises will advise the owner of recommended repair or replacement costs. The ballistic/stab-resistant elements of this system will reduce the possibility of serious physical injury to the wearer in the areas covered by the ballistic or stab elements. There should be no expectation of bullet or stab resistance in areas not covered by the ballistic or stab element. The ballistic or stab element is not warranted to be bulletproof or stab proof.

Research and Development

Bid Specifications

441024

5.2.4. Warranty Coverage Exceptions

The warranty does not cover and is void for:

- Any garment altered or modified in any way other than Point Blank Enterprises authorized factory alterations
- Any ballistic or stab element that has been altered or modified in any way other than Point Blank Enterprises authorized factory alterations
- Any ballistic or stab element not in a Point Blank Enterprises outer shell carrier from any of the core brands (Point Blank Body Armor, Protective Apparel Corporation of America (PACA), Protective Products or PARACLETE®) except as approved by Point Blank Enterprises
- Damage as a result of abuse or misuse
- Damage as a result of improper storage or maintenance
- Penetrations as a result of ballistic or stab testing
- The results of any specific ballistic or stab testing
- Injury as a result of bullets or other projectiles or instruments not impacting the ballistic or stab element
- The warranted items herein are expressly in lieu of other warranties, express or implied, including the implied warranties of merchantability, fitness for particular purpose and other warranties arising from a course of dealing, usage or trade
- There are no warranties, express or implied, including the implied warranty of merchantability, which extend beyond the description on the face hereof. There are no warranties, express or implied, that extend beyond the warranty period set forth herein

6. Product Liability Insurance

Vest manufacturer shall agree to provide a minimum of \$26,000,000 product liability insurance coverage on delivered vests.

Research and Development

Bid Specifications

441024

7. Silence of Specifications

Commercially accepted practices shall apply to any detail not covered in this specification and to any omission of this specification. Any omission or question of interpretation of the specification which affects the ballistic performance or integrity of the soft body armor being offered shall be addressed in writing and submitted with the bid.

8. Labeling

8.1. Material

Label material shall withstand normal wear and cleaning and remain readable during the entire warranted life of the armor or carrier.

8.2. Label Requirements

All soft body armor shall be labeled in strict adherence to the label requirements identified in NIJ-Standard-0101.06, Ballistic Resistance of Body Armor, and the NIJ's Compliance Testing Program (CTP).

The ballistic panel label shall include, but not be limited to the following:

- Name of Manufacture
- Manufacture Address
- Level of Protection
- NIJ-0101.06
- Date of Manufacture
- Date Issue
- Size
- Serial Number
- Model of Vest
- Care Instructions
- Warranty Period
- Warranty Contact Information



Research and Development Bid Specifications

441024

9. Post Certification Retest Policy/Used Vest Evaluation Recommendations

Point Blank Enterprises, Inc. (PBE), which includes Point Blank Body Armor, Protective Apparel Corporation of America (PACA), Protective Products Enterprises (PPE), and Paraclete, encourage valid body armor testing for the purpose of acceptance testing of new vests, and as a tool to be used to evaluate used body armor replacement cycles. In order to provide our customers with guidance in this area, we offer the following recommendations that may help in providing the tools to make informed decisions in buying new armor as well as replacing used armor.

PBE recognize and recommends properly performed ballistic testing in accordance with NIJ-0101.06 CTP Conformity Assessment Section 7.5 (NIJ BA CTP Application Package: 005) for new armors. All testing will be performed at an NIJ approved ballistic test laboratory. Only bullets listed in NIJ-Standard-0101.06 table 10 will be utilized. Each ballistic test shall be conducted on a complete vest and in accordance with NIJ-0101.06 CTP Conformity Assessment Section 7.5 (NIJ BA CTP Application Package: 005). Panels shall be shot against clay backing material, which has been conditioned in accordance with NIJ-0101.06. Prior to each shot, the panel will be placed flat against the clay backing material. For acceptance testing, vest samples shall be new and in unused condition.

9.1. Minimum Sample Size

In order to have valid test data, minimum representative samples should be tested. For new vests acceptance testing the recommended minimum representative sample size should be no less than 3 vests (6 panels). In the case of used vest evaluation testing, the recommended minimum representative sample size should be 5 vests (10 panels). Representative samples should be of the same model and in the case of used vests, the same Wear Rating category.

9.2. New Vest Testing Recommendations

For acceptance testing of new, unused vests, the armor should be expected to have no perforations at the NIJ-0101.06 reference velocities. In addition, BFS will not be measured in accordance with NIJ-0101.06 CTP Conformity Assessment Section 7.5 - NIJ BA CTP Application Package: 005.



Research and Development

Bid Specifications

441024

9.3. Additional Samples Sets - If there is a perforation of a representative armor sample during the initial testing, then additional samples should be tested to verify the results of the initial testing. It is recommended that three additional samples sets be tested. In order for the representative sample group to be acceptable, there should be no perforations in any of the additional samples sets at the NIJ-0101.06 reference velocities for that class of armor.

10. NIJ-0101.06 Reference Velocities

Refer to Table 4 P-BFS performance test summary chart. Page 46 NIJ-Standard- 0101.06.

11. Used Vest Evaluation

Used body armor evaluations are necessary and will help the consumer or organizational administrator in determining when to replace armor that is past its practical service life. The following information and recommendations are offered and may be useful in making these determinations.

Vests that are in service will experience some loss of ballistic performance as a result of normal wear. The amount of wear or lack of proper care is closely related to the amount of performance loss. Therefore it is critical that body armor is cared for and stored as recommended by the manufacturer. In addition, armor should be inspected on a regular basis for signs of unusual wear and/or improper care. Armors that are found to be in poor condition should be replaced as soon as possible. In addition, if there are breaks in the ballistic cover (torn, worn through, open seams) the vest should be taken out of service and replaced immediately. It should be clearly understood that wear rates are not directly related to time in service or length of the manufacturer's warranty. Armor wear is similar to automobile tire wear. Some drivers wear out tires faster than others. Similarly, some officers wear out their vests sooner than others. Vests that are worn out should be replaced regardless of the time it has been service or the length of the manufacturer's warranty.



Research and Development Bid Specifications

441024

11.1. Used Vest Inspection and Rating

Due to the potential wear condition variability of used vest samples each vest sample must be inspected on a regular basis for wear condition and any indications of abuse or improper care. After inspection the samples should be Wear Rated according to their condition and if ballistic testing is anticipated, grouped accordingly. The recommended Wear Ratings categories are listed below:

- **Wear Rating #1 - Good condition** - Light wear, no set wrinkles or stains, ballistic cover intact
- **Wear Rating # 2 - Fair condition** - Moderate wear, some set wrinkles at edges, light staining, and ballistic cover intact
- **Wear Rating # 3 - Poor condition** - Replacement should be considered if any of the following are present: Heavy wear, set wrinkles, staining of the ballistic cover, breaks in the ballistic cover or open seams
- **Wear Rating # 4 - Very poor condition** - Should be taken out of service and replaced if any of the following are present: Creases, folds, set wrinkles, staining or signs of mildew or chemical contact, breaks in the ballistic cover, open seams, ballistic cover very worn or worn through

11.2. Used Vest Degradation

If ballistic testing is conducted, it should be expected that used vest samples will show some performance degradation over new unused vest samples. It should also be expected that some used vest samples will show performance degradation that may be below the NIJ-0101.06 reference velocity for new vests. Although this may be the case in some used vest samples, it should be understood that actual street threat velocities are lower than the NIJ-0101.06 reference velocity according to manufacturer's published literature.

Research and Development Bid Specifications

441024

11.3. Manufacturers Bullet/Cartridge Muzzle Velocities

Caliber	Bullet	Muzzle Velocity	Manufacturer
40 S&W	180 Gr. FMJ	985 FPS	Remington
40 S&W	180 Gr. FMJ	990 FPS	Winchester
40 S&W	180 Gr. FMJ	985 FPS	American Eagle
9MM	124 Gr. FMJ	1100 FPS	Remington
9MM	124 Gr. FMJ	1140 FPS	Winchester
9MM	124 Gr. FMJ	1120 FPS	American Eagle
357 Mag.	158 Gr. JSP	1235 FPS	Remington
357 Mag.	158 Gr. JSP	1235 FPS	Winchester
357 Mag.	158 Gr. JSP	1240 FPS	American Eagle
357 Sig	125 Gr. FMJ	1325 FPS	Remington
357 Sig	125 Gr. TMJ	1325 FPS	Speer
357 Sig	125 Gr. FMJ	1350 FPS	American Eagle
44 Mag.	240 Gr. SJHP	1180 FPS	Remington
44 Mag.	240 Gr. SJHP	1180 FPS	Winchester
44 Mag.	240 Gr. SJHP	1230 FPS	Federal

11.4. Recommended Used Vest Evaluation Testing

Although the NIJ-STD-0101.06 makes no direct correlation between “Conditioned Vest testing” and actual used vest service life, the reference velocities for “conditioned” vest could be utilized as a guide for testing used vests. “This protocol will not predict the service life of the vest nor does it simulate an exact period of time in the field.” (Pg. 27 NIJ-0101.06).

11.5. Used Vest Ballistic Performance Expectations

Wear Rating #1, # 2 or #3 - Good Fair and Poor Condition - When testing representative sample groups with Wear Ratings of #1, #2 or #3, there should be no perforations below the Conditioned Armor test velocities as set forth in the NIJ 0101.06 Compliance Testing Program. Refer to Table 4 P-BFS performance test summary chart. Page 46 NIJ-Standard-0101.06. If there is a perforation of a representative armor sample during the initial testing, then three additional representative samples sets should be tested to verify the results of the initial testing. If the verification testing results in any additional perforations, then it is recommended that the representative group is replaced by the agency.

Wear Rating # 4 - Very poor condition - Since vests in this category should be replaced, there should be no specific expectation of ballistic performance. Although some vests in this category may still provide ballistic protection, tests results will not be consistent and therefore cannot be relied upon.

Galveston Co. S.O.

TIES: Samuel Broome 100% polyester tie 3" with button holes. Come in 4 different sizes: 14.5", 18", 20" and 22".

GSO PINS: G.S.O. collar pins in gold or silver. Must match existing pins

BAGS: Premier Emblem duty bag in black. Will have current Galveston Co. Sheriff's Office logo on top of bag. Style PBG-081/Galveston Co. Sheriff's Office

Ballcaps: Max Apparel style MX067 with Galveston Co. Sheriff's Office Logo on front of cap and SHERIFF on back closure of cap.

HOLSTER: Safariland style number 6280 in hi-gloss with or without light attachment

MAGAZINE HOLDER: Safariland style number 77 in hi-gloss

CUFF CASE: Safariland style number 190 or 190B in hi-gloss

SINGLE KEEPERS: Dutyman style number 2431 or 2431B

DOUBLE KEEPERS: Dutyman style number 2231 or 2231B

~~**ASP BATON HOLDER:** Safariland style number 35 in hi gloss~~

FLASHLIGHT HOLDER: Safariland style number 306 in hi-gloss

DUTY BELT: Dutyman style number 1031 in hi-gloss

MACE HOLDER: Safariland style number 38 in hi-gloss

Safariland Duty Gear Technical Specification Package

Model 6280 and 6285

General Description

Standard Level II Retention™ duty Holster for pistol or revolver handguns, Level III Retention™ if tension screw is firmly adjusted or Sentry device is added, Level IV Retention™ if tension screw is firmly adjusted and Sentry device is added. Designed for use on a Safariland Sam Browne 2 ¼" (58mm) or 2" (50mm) Belt.

Product Function

Maintains handgun in a stable, tactically ready configuration, Self Locking System "SLS". Utilizes locking push down thumb platform and rotating hood to reduce take away potential. Very easy to re-holster and secure by rotating hood back over handgun with Self Locking Snap-Free operation. Holster uses tension device for handgun adjustment. Belt loop uses new, UBL (Universal Belt Loop) friction style design. Optional Sentry locking device (6001) can be mounted to any SLS system. Sentry provides an additional level of security. To operate the Sentry slide button forward with thumb to engage, slide Sentry back to disengage. Incorporates internal notch to keep lock engaged or disengaged under normal use. Injection molded out of impact resistant nylon. 6285 has a 1 ½" drop belt loop with jacket slot and for female use.

Construction Materials

Lamination of polyurethane and synthetic suede non-woven: nylon micro fiber material for holster liner to assist with the protection of the handgun. #207 and #277 nylon cord stitching. Case hardened nylon screws and T-Nuts are used as fastening devices. Polyester elastomer injection molded "SLS" strap with corrosion resistance stainless steel Hardware. Impact resistant reinforced Nylon SLS body. Hi-Carbon tempered steel spring with corrosion resistant film protectant. Must be able to withstand a minimum of 48 hours submerged in water and retain shape and function. Exterior material to pass minimum of 2000 cycles at 1000 gms on taber abrasion test with H18 wheels.

Available Finishes

Plain, Basketweave, Hi Gloss, Nylon Look, STX finishes

Available Belt Loops

Standard 2 ¼" (58mm) or 2" (50mm) Universal Belt Loop (UBL)

Manufacturing Process

Holster body is heat and pressure molded to fit your specified gun with wraparound welt less construction. Sight channel is molded in. Beltloop is injection molded for body curvature.

Dimensions and weights may vary for each gun model.

Dimensions and Weights:

	<u>Imperial</u>	<u>Metric</u>
Weight:	0.70 lb.	272.15 gr.
Length:	8 ¼"	20.9550 cm.
Height:	3 ¾"	9.5250 cm.
Width:	4"	10.16 cm.

Patent Information

6280/6285 falls under patents: U.S. Pat. #- 5,501,381

Quality Control

ISO 9001 Societe Generale de Surveillance – ANSI RAB Registrar AQS Quality Procedure.

Insurance Coverage

Safariland is insured with Product Liability coverage.

**Safariland Duty Gear Technical Specification Package
Model 6280 and 6285**

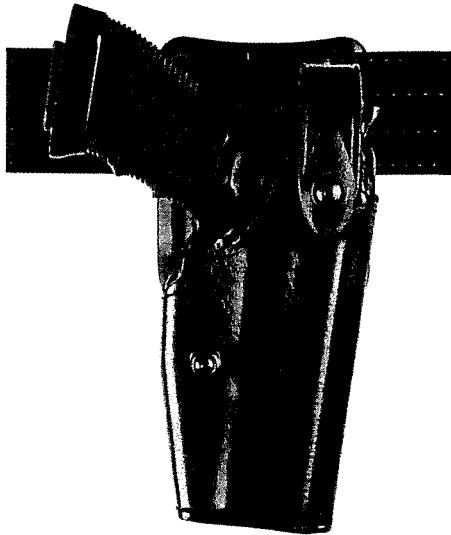

6285

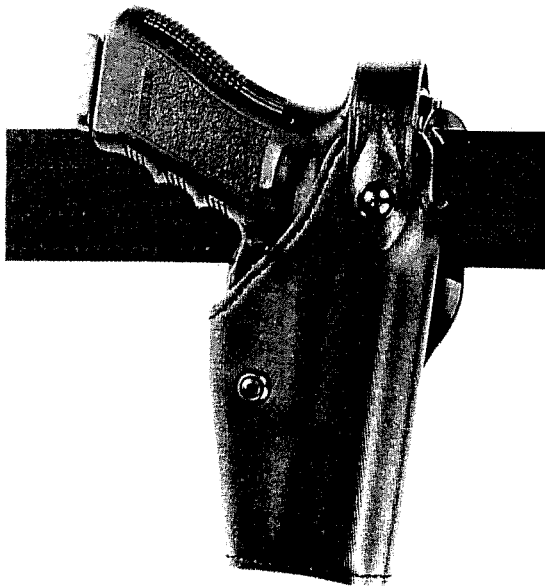

6280

Safariland Duty Gear Technical Specification Package

Model 77 and 77HS

General Description

Double magazine pouch designed to carry two reloading magazines for pistol handguns.

Product Function

Carries two magazines in two separate holders in a stable, tactically ready configuration (Water drain holes). Magazines ride in butt up position. Flap closure devices fasten over magazines to hold them firmly in place. Cut low for excellent access to magazines, with up to 1 ½" drop. Slides on belt and rides in vertical or horizontal position.

Weatherproof. A tension screw located between the two pouches allows for easy magazine retention adjustment, with 5/8" space between each pouch for easy grip. Snap version has female regular snaps on tips of flaps mate with male regular, snaps. 77HS Hidden Snap Version - Female snaps are Concealed or hidden on the inside of the tips of the flaps, no hardware is exposed on the outside of flap. For use on Sam Browne 2" (50mm), 2 ¼" (58mm) or Nylon reinforced Duty Belts.

Construction Materials

The two holders are laminated using an engineered copolymer on the inside and polyurethane on the outside. The flaps and belt loop are laminated with one layer of polyurethane laminated and stitched to 3 ½ - 4 ounce pebble-finished split leather for strength and flexibility. TRW/Dot regular snaps. #207 nylon cord stitching.

Note: STX Tactical series is manufactured with Nylon Look finish, black plastic covered snaps, and hair cell engineered copolymer magazine box.

Available Finishes

Plain, Basket weaves, Hi-Gloss, Nylon Look, STX Tactical finish.

Available Belt Loops

Standard 2 ¼" belt loop.

Manufacturing Process

Laminate will be glued and heat and pressure formed to specified magazine. All edges to be sanded smooth and burnished. Stitched together with #207 Nylon cord.

Dimensions and Weights:

	<u>Imperial</u>	<u>Metric</u>
Weight:	.28 lbs.	127 gr
Length:	6"	15.24 cm
Height:	2"	5.08 cm
Width:	4 ½"	11.43 cm

Quality Control

ISO 9001 Societe Generale de Surveillance – ANSI RAB Registrar AQS Quality Procedure.

Insurance Coverage

Safariland is insured with Product Liability coverage

Safariland Duty Gear Technical Specification Package Model 77 and 77HS

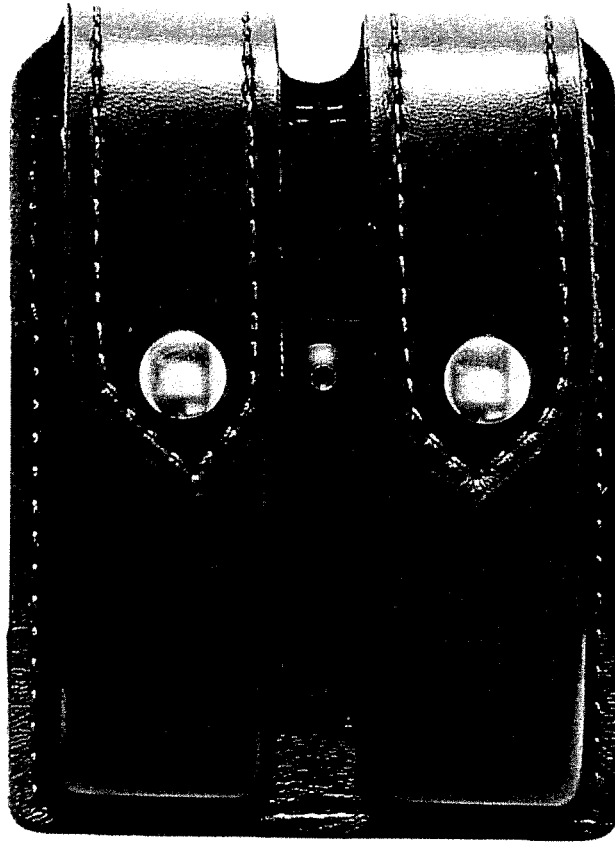

Rev. 3-14-05

Safariland LLC
3120 East Mission Boulevard* P.O. Box 51478* Ontario, California 91761 U.S.A.
Tel. (909) 923-7300 Fax (909) 923-7400 www.safariland.com

Safariland Duty Gear Technical Specification Package Model 190 and 190H

General Description

Tapered duty handcuff pouch designed to carry one pair of standard (190) and hinged (190H) handcuffs of a peerless or Smith & Wesson style. For use on 2 - 2 ¼" (50-58 mm) duty belts.

Product Function

Carries one pair of standard handcuffs in a stable, tactically ready configuration. Cuffs ride with locking mechanism at the bottom. Flap closure device snaps over cuffs to hold them firmly in place. Female regular snap on tip of flap mates with male regular snap on pouch body. Pouch has finger cut-out in front to facilitate removal of handcuffs. Slides onto the belt and rides in vertical position. Weatherproof. Water drain hole.

Construction Materials

The holder is laminated of engineered copolymer encased by polyurethane on the outside and Buc suede on the inside. Back and flap are each laminated with 3 1/2 – 4 ounce leather and polyurethane. TRW/DOT regular snap. #207 nylon cord stitching.

Available Finishes

Plain, Basketweave, Hi-Gloss, Nylon Look, STX Tactical®.

Available Belt Loops

Standard 2 ¼" (58 mm) belt loop.

Manufacturing Process

Laminate is bonded with glue and heat and pressure formed. All edges are sanded smooth and burnished. Stitched together with #207 nylon cord.

Dimensions and Weights:

	<u>Imperial</u>	<u>Metric</u>
Weight:	.20 lb.	90.71 gr
Length:	5"	12.7 cm
Height:	2"	5.08 cm
Width:	4"	10.16 cm

Quality Control

ISO 9001 Societe Generale de Surveillance – ANSI RAB Registrar AQS Quality Procedure.

Insurance Coverage

Safariland is insured with Product Liability coverage.

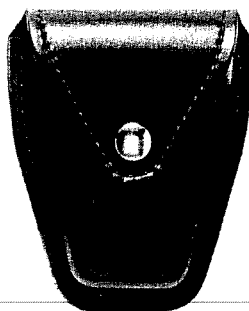

Safariland Duty Gear Technical Specification Package

Model 35

General Description

Open top expandable baton carrier designed to hold batons on 2-1/4" duty belts in a vertical position. Designed with an opening at the bottom to allow baton to be re-holstered in its expanded position.

Product Function

Carries expandable baton in a stable, tactically ready position. Baton sits with top in upright position, and rides vertically. Open top allows excellent accessibility. Uses tension screws to allow for adjustment of tension on baton. Pouch is weatherproof and hole at the bottom doubles as a water drain hole.

Construction Materials

The rounded portion of carrier is laminated with polyurethane on the outside and an engineered copolymer on the inside. The back or belt loop portion is polyurethane, 3 1/2 - 4 ounce leather, and an engineered copolymer. Stitched at all laminated edges with #207 and #277 nylon cord. All edges are sanded and burnished; sharp corners are rounded. Casehardened, rust resistant hardware is used for the tension device. A highly durable foam acts as a pocket at bottom of pouch which prevents baton from extending when not in use.

Available Finishes

Plain, Basketweave, Hi-Gloss, Nylon Look, STX[®] Tactical finish.

Manufacturing Process

Laminate is bonded with glue and heat and pressure formed. All edges are sanded smooth and burnished. Stitched together with #207 and #277 nylon cord.

Note- Dimensions and weights are based using an F21 baton pouch.

Dimensions and Weights:

	<u>Imperial</u>	<u>Metric</u>
Weight:	.14 lbs.	.07 kg.
Length:	5 1/8"	13cm
Height:	1 1/4"	3.2 cm
Width:	2 5/8"	6.7 cm

Quality Control

ISO 9001 Societe Generale de Surveillance – ANSI RAB Registrar AQS Quality Procedure.

Insurance Coverage

Safariland is insured with Product Liability coverage.

**Safariland Duty Gear Technical Specification Package
Model 35**

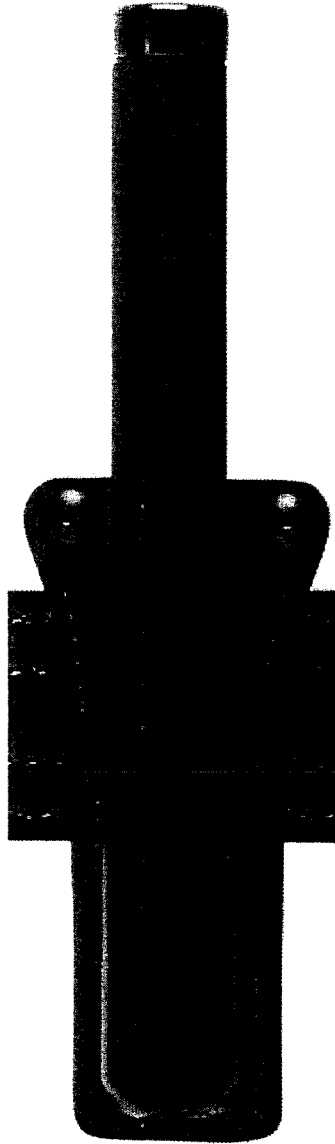

Safariland Duty Gear Technical Specification Package Model 306

General Description

Flashlight carrier with flap is designed to hold mini-flashlights on 2-1/4" (58 mm) duty belts.

Product Function

Carries flashlight in a stable, tactically ready configuration. Light sits with lens in upright position. Slides onto or snaps around the belt. Rides in a vertical position. Flap with snap closure covers top of light. Closed bottom. Weatherproof. Water drain hole.

Construction Materials

The rounded portion of carrier is laminated with copolyester sheeting encased by an engineered material and Buc suede on the inside. The back or belt loop portion is copolyester sheeting encased again by engineered material. Stitched at all laminated edges with #207 nylon cord.

Note: STX Tactical® series is manufactured with nylon look material, and a haircell engineered copolymer mag box.

Available Finishes

Plain, Basketweave, Hi-Gloss, Nylon Look, STX Tactical®

Available Belt Loops

Standard 2 1/4" (58 mm) belt loop.

Manufacturing Process

Laminate is bonded with glue and heat and pressure formed. All edges are sanded smooth and burnished. Stitched together with #207 nylon cord.

Dimensions and Weights:

	<u>Imperial</u>	<u>Metric</u>
Weight:	.22 lbs.	.08 kg
Length:	6 1/8"	15.558 cm
Height:	2 3/4"	5.715 cm
Width:	1 3/4"	4.445 cm

Patent Information:

306 falls under patents: U.S. Pat. No. 4,340,437

Quality Control

ISO 9001 Societe Generale de Surveillance – ANSI RAB Registrar AQS Quality Procedure.

Insurance Coverage

Safariland is insured with Product Liability coverage.



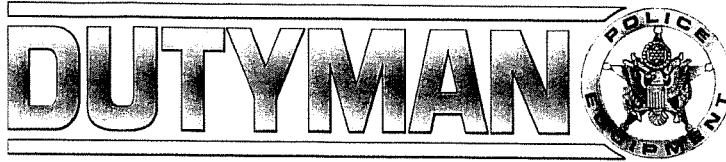

6460 CAMINO REAL * P.O. BOX 39 * MAXWELL, TX 78656
Phone (512) 357-2968 TOLL FREE FAX 800 836-7291

June 30, 2015

The **1031** is a black Clarino 2 ¼" Sam Browne belt made of 10-11oz. full grain vegetable tan leather, with a 2-3oz. top layer of Clarino. The Clarino is attached to the leather with an adhesive and stitched the full length of the belt with 9 gram nylon thread in two rows, each approximately 1/8th of an inch from the outer edge of the belt. One end of the belt has a steel double hook glued and stitched on to connect to the buckle. There is also a solid brass post with a black finish riveted in approximately two inches behind the steel hook. The buckle end has five sets of adjustment holes. The buckle is a square, two prong center bar buckle. The 1031 is available with a zinc buckle with nickel or gilt plating, or a solid brass buckle with a nickel or brass finish. Available in even sizes from 28 to 60.

The **2431** is a ¾" wide Clarino keeper made of 5-6 oz. full grain vegetable tan leather, with a 2-3oz. top layer of Clarino. The Clarino is attached to the leather with an adhesive and stitched the full length of the keeper with 9 gram nylon thread. The keeper has two snaps and will fit up to a 2 ¼" belt. The snaps are available in nickel, brass or black or it can have hook and loop closure instead of snaps.

The **2231** is a 2" wide Clarino keeper made of 5-6 oz. full grain vegetable tan leather, with a 2-3oz. top layer of Clarino. The Clarino is attached to the leather with an adhesive and stitched the full length of the keeper with 9 gram nylon thread. The keeper has four snaps and will fit up to a 2 ¼" belt. The snaps are available in nickel, brass or black.

Safariland Duty Gear Technical Specification Package

Model 38

General Description

Mace/pepper type carrier with flap closure designed to fit on 2" - 2 ¼" (50-58 mm) duty belts.

Product Function

Carries OC/CS canister in a stable, tactically ready configuration. Canister sits with top in upright position. Flap closure device snaps over canister to hold it firmly in place. Female regular snap on tip of flap mates with male regular snap on carrier body. Open side area at top facilitates removal of canister. Slides onto the belt. Rides in vertical position. Closed bottom. Weatherproof. Water drain hole.

Construction Materials

The pouch is laminated of polyurethane, an engineered copolymer, and Buc Suede on the inside. The flap is laminated with 3 ½ - 4 ounce leather and polyurethane on the outside. The belt loop is also laminated with 3 ½ - 4 ounce leather and polyurethane. Stitched at all laminated edges with #207 and #277 nylon cord. TRW/DOT regular snap.

Available Finishes

Plain, Basketweave, Hi-Gloss, Nylon Look, STX Tactical finish

Available Belt Loops

Standard 2 ¼" (50-58 mm) belt loop.

Manufacturing Process

Laminate is bonded with glue and heat and pressure formed. All edges are sanded smooth and burnished. Stitched together with #207 and #277 nylon cord.

Dimensions and Weights:

	<u>Imperial</u>	<u>Metric</u>
Weight:	.16 lbs.	72.56 gr
Length:	7 ½"	19.05 cm
Height:	2 ¼"	5.715 cm
Width:	2 ¼"	5.715 cm

Quality Control

ISO 9001 Societe Generale de Surveillance – ANSI RAB Registrar AQS Quality Procedure.

Insurance Coverage

Safariland is insured with Product Liability coverage.

Safariland Duty Gear Technical Specification Package Model 38

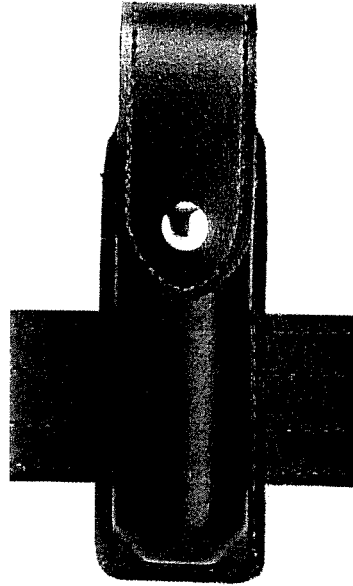

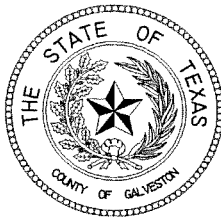

County of Galveston
ACKNOWLEDGMENT AND CERTIFICATION REGARDING DEBARMENT,
SUSPENSION, AND OTHER INELGIBILITY
Executive Orders 12549 & 12689 Certification, Debarment and Suspension

Solicitation Number: Bid #B152013

Solicitation Title: Sheriff Department Uniforms & Supplies

Contractor hereby CERTIFIES that:

Contractor, and all of its principals, is not presently debarred, suspended, proposed for debarment, proposed for suspension, or declared ineligible under Executive Order 12549 or Executive Order 12689, Debarment and Suspension, and is not in any other way ineligible for participation in Federal or State assistance programs;

Contractor, and all of its principals, were not and have not been debarred, suspended, proposed for debarment, proposed for suspension, or declared ineligible under Executive Order 12549 or Executive Order 12689, Debarment and Suspension, and were not and have not been in any other way ineligible for participation in Federal or State assistance programs at the time its' proposal was submitted in the procurement identified herein and at any time since submission of its' proposal;

Contractor has included, and shall continue to include, this certification in all contracts between itself and any sub-contractors in connection with services performed under this contract; **and**

Contractor shall notify Galveston County in writing immediately, through written notification to the Galveston County Purchasing Agent, if Contractor is not in compliance with Executive Order 12549 or 12689 during the term of its contract with Galveston County.

Contractor **Represents** and **Warrants** that the individual executing this Acknowledgment and Certification on its behalf has the full power and authority to do so and can legally bind the Contractor hereto.

Name of Business

Date

By: _____
Signature

Printed Name & Title

BID #: B152013
OPEN: 08/13/2015
3:00 PM

BID SHEET

SHERIFF DEPARTMENT UNIFORMS & SUPPLIES

GALVESTON COUNTY, TEXAS

Having read and understood the instructions, terms, conditions, specifications, and inv
to bid we submit the following:

LINE ITEM TOTAL \$ _____

OPTIONS TO RENEV 2 Extensions/1 Year Options

WITNESS

COMPANY NAME

DATE

AUTHORIZED REPRESENTATIVE'S SIGNATURE

PRINTED NAME

TITLE

CORRESPONDENCE ADDRESS

REMIT ADDRESS

CITY, STATE ZIP CODE

CITY, STATE ZIP CODE

TAX IDENTIFICATION NUMBER (TIN/FIEN/SSN)

TELEPHONE NUMBER

FAX NUMBER

ADDENDUM'S RECEIVED #1 _____ #2 _____ #3 _____

LINE ITEM DETAIL

BID #: B152013
OPEN: 08/13/2015
3:00 PM

SHERIFF DEPARTMENT UNIFORMS & SUPPLIES
GALVESTON COUNTY, TEXAS

VENDOR ID

Item No.	Product Code	Description	Quantity	Units	Catalog #	Unit Price	Extended Price
0001	98386	MEN'S SHORT SLEEVE PATROL SHIRT (STYLE HS1546)	200	EA		\$ _____	\$ _____
0002	98386	MEN'S SHORT SLEEVE PATROL SHIRT - OVERSIZE (STYLE HS15460S)	50	EA		\$ _____	\$ _____
0003	98386	LADIE'S SHORT SLEEVE PATROL SHIRT (STYLE HS1547)	200	EA		\$ _____	\$ _____
0004	98386	LADIE'S SHORT SLEEVE PATROL SHIRT - OVERSIZE (STYLE HS15470S)	50	EA		\$ _____	\$ _____
0005	98386	MEN'S LONG SLEEVE PATROL SHIRT (STYLE HS1544)	200	EA		\$ _____	\$ _____
0006	98386	MEN'S LONG SLEEVE PATROL SHIRT - OVERSIZE (STYLE HS15440S)	50	EA		\$ _____	\$ _____

LINE ITEM DETAIL

BID #: B152013
OPEN: 08/13/2015
3:00 PM

SHERIFF DEPARTMENT UNIFORMS & SUPPLIES
GALVESTON COUNTY, TEXAS

VENDOR ID	Item No.	Product Code	Description	Quantity	Units	Catalog #	Unit Price	Extended Price
	0007	98386	WOMEN'S LONG SLEEVE PATROL SHIRT (STYLE HS1545)	200	EA		\$ _____	\$ _____
	0008	98386	LADIE'S LONG SLEEVE PATROL SHIRT - OVERSIZE (STYLE HS1545OS)	50	EA		\$ _____	\$ _____
	0009	98386	MEN'S PATROL PANT (STYLE HS2712)	200	EA		\$ _____	\$ _____
	0010	98386	MEN'S PATROL PANT - OVERSIZE (STYLE HS2712OS)	50	EA		\$ _____	\$ _____
	0011	98386	LADIE'S PATROL PANT (STYLE HS2713)	200	EA		\$ _____	\$ _____
	0012	98386	LADIE'S PATROL PANT - OVERSIZE (STYLE HS2713OS)	50	EA		\$ _____	\$ _____
	0013	98386	MEN'S CARGO POCKET PANT (STYLE 74273-162)	300	EA		\$ _____	\$ _____
	0014	98386	MEN'S CARGO POCKET PANT - OVERSIZE (STYLE 74273L-162)	50	EA		\$ _____	\$ _____

LINE ITEM DETAIL

BID #: B152013
OPEN: 08/13/2015
3:00 PM

SHERIFF DEPARTMENT UNIFORMS & SUPPLIES
GALVESTON COUNTY, TEXAS

VENDOR ID	Item No.	Product Code	Description	Quantity	Units	Catalog #	Unit Price	Extended Price
	0015	98386	LADIE'S CARGO POCKET PANT (STYLE 64360-162)	100	EA		\$	\$
	0016	98386	LADIE'S CARGO POCKET PANT - OVERSIZE (STYLE 64360L-162)	50	EA		\$	\$
	0017	98386	JAILER SHORT SLEEVE SHIRT (STYLE 85R5806)	300	EA		\$	\$
	0018	98386	JAILER SHORT SLEEVE SHIRT - OVERSIZE (STYLE 85R5806OS)	50	EA		\$	\$
	0019	98386	JAILER LONG SLEEVE SHIRT (STYLE 35R5806)	100	EA		\$	\$
	0020	98386	JAILER LONG SLEEVE SHIRT - OVERSIZE (STYLE 35R5806OS)	50	EA		\$	\$
	0021	98386	JAILER RAINCOAT - REVERSIBLE (STYLE 70C3/L)	50	EA		\$	\$
	0022	98386	PATROL RAINCOAT - REVERSIBLE (STYLE 70F3/L)	50	EA		\$	\$

LINE ITEM DETAIL

BID #: B152013
 OPEN: 08/13/2015
 3:00 PM

SHERIFF DEPARTMENT UNIFORMS & SUPPLIES
 GALVESTON COUNTY, TEXAS

VENDOR ID	Item No.	Product Code	Description	Quantity	Units	Catalog #	Unit Price	Extended Price
	0023	98386	SAFETY VEST WITH SHERIFF (STYLE HS572S)	50	EA		\$ _____	\$ _____
	0024	98386	HANDCUFF CASE (STYLE 190)	50	EA		\$ _____	\$ _____
	0025	98386	MACE HOLDER (STYLE 38)	50	EA		\$ _____	\$ _____
	0026	98386	FLASHLIGHT HOLDER (STYLE 306)	50	EA		\$ _____	\$ _____
	0027	98386	HOLSTER (STYLE 6280)	50	EA		\$ _____	\$ _____
	0028	98386	EXPANDABLE BATON HOLDER (STYLE 35)	50	EA		\$ _____	\$ _____
	0029	98386	MAGAZINE HOLDER (STYLE 77)	50	EA		\$ _____	\$ _____
	0030	98386	DUTY BELT (STYLE 1031)	50	EA		\$ _____	\$ _____
	0031	98386	SINGLE KEEPER (STYLE 2431)	100	EA		\$ _____	\$ _____

LINE ITEM DETAIL

BID #: B152013
OPEN: 08/13/2015
3:00 PM

SHERIFF DEPARTMENT UNIFORMS & SUPPLIES
GALVESTON COUNTY, TEXAS

VENDOR ID	Item No.	Product Code	Description	Quantity	Units	Catalog #	Unit Price	Extended Price
	0032	98386	DOUBLE KEEPER (STYLE 2231)	100	EA		\$ _____	\$ _____
	0033	98386	TIES (STYLE 90010)	100	EA		\$ _____	\$ _____
	0034	98386	GSO COLLAR PINS (STYLE 1/2" CSO)	100	EA		\$ _____	\$ _____
	0035	98386	GSO DUTY BAGS (STYLE PBG081-GCSD)	50	EA		\$ _____	\$ _____
	0036	98386	GALVESTON CO.S.O. BALLCAP (STYLE MX067)	150	EA		\$ _____	\$ _____
	0037	98386	BALLISTIC VEST - MALE AND FEMALE (STYLE AXIII A)	25	EA		\$ _____	\$ _____
	0038	98386	MALE MARINE DIVISION S/S SHIRT W/EMBROIDERY (STYLE 8805N)	50	EA		\$ _____	\$ _____
	0039	98386	MALE MARINE DIVISION S/S SHIRT W/EMBROIDERY - OVERSIZE (STYLE 8805NOS))	10	EA		\$ _____	\$ _____

LINE ITEM DETAIL

BID #: B152013
OPEN: 08/13/2015
3:00 PM

SHERIFF DEPARTMENT UNIFORMS & SUPPLIES

GALVESTON COUNTY, TEXAS

VENDOR ID

Item No.	Product Code	Description	Quantity	Units	Catalog #	Unit Price	Extended Price
0040	98386	FEMALE MARINE DIVISION S/S SHIRT W/EMBROIDERY (STYLE 8804LC)	50	EA		\$ _____	\$ _____
0041	98386	FEMALE MARINE DIVISION S/S SHIRT W/EMBROIDERY - OVERSIZE (STYLE 8804LCOS)	10	EA		\$ _____	\$ _____
0042	98386	MALE MARINE DIVISION L/S SHIRT W/EMBROIDERY (STYLE 8803N)	50	EA		\$ _____	\$ _____
0043	98386	MALE MARINE DIVISION L/S SHIRT W/EMBROIDERY - OVERSIDE (STYLE 8803NOS)	10	EA		\$ _____	\$ _____
0044	98386	FEMALE MARINE DIVISION L/S SHIRT W/EMBROIDERY (STYLE 8802LC)	50	EA		\$ _____	\$ _____
0045	98386	FEMALE MARINE DIVISION L/S SHIRT W/EMBROIDERY - OVERSIZE (STYLE 8802LCOS)	10	EA		\$ _____	\$ _____
0046	98386	ALTERATIONS FOR REUTILIZED UNIFORMS - HEM	100	EA		\$ _____	\$ _____

LINE ITEM DETAIL

BID #: B152013
OPEN: 08/13/2015
3:00 PM

SHERIFF DEPARTMENT UNIFORMS & SUPPLIES

GALVESTON COUNTY, TEXAS

VENDOR ID

Item No.	Product Code	Description	Quantity	Units	Catalog #	Unit Price	Extended Price
0047	98386	ALTERATIONS FOR REUTILIZED UNIFORMS - ALTER WAIST	100	EA		\$ _____	\$ _____
0048	98386	ALTERATIONS FOR REUTILIZED UNIFORMS - TAPER	100	EA		\$ _____	\$ _____
0049	98386	ALTERATIONS FOR REUTILIZED UNIFORMS - CHANGE NAME	100	EA		\$ _____	\$ _____
Extended Price Total of all Iter							\$ _____

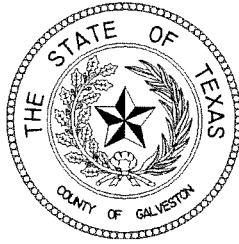

State of Texas

County of Galveston

Contract

This Contract is entered into between the County of Galveston, a political subdivision of the State of Texas and the Contractor named below pursuant to Texas Local Government Code, Chapter 262, Subchapter C and the referenced invitation to bid.

Contract Number: CM15211

Invitation to Bid Number: Bid# B152013 Sheriff Department Uniforms & Supplies

Term of Contract: One (1) year with two (2) one (1) year extensions

Initial term (Services): Beginning date of the contract will be _____. The contract will terminate on _____.

Term of Completion (Construction or other time specific contract): The Contractor shall complete the work within N/A Calendar Days of the issuance of the notice to proceed. The time set forth for completion of the work is an essential element of the job.

Renewal Options: (if applicable):

Year One: Yes (X) No ()
Year Two: Yes (X) No ()
Year Three: Yes () No (X)
Year Four: Yes () No (X)

Contractor: _____

Awarded as to addendum(s) (if applicable):

Addendum No. 1: () yes () no () n.a.
Addendum No. 2: () yes () no () n.a.
Addendum No. 3: () yes () no () n.a.

Payment Bond Required: () yes (X) no

Performance Bond Required: () yes (X) no

Notice to be Given to:

Galveston County:

County Purchasing Agent
Galveston County
722 Moody
Fifth (5th) Floor
Galveston, Texas 77550

Contractor:

County and Contractor agree as follows:

1. **Parts of Contract:** Sections I (Invitation to Bid; Instructions to Bidders), II (Bid Proposal; Contract Award), III (Special Terms and Conditions, including Specifications, Drawings and Addenda, if any), and IV (General Terms and Conditions) attached to this Contract Award are all made a part of this Contract and collectively evidence and constitute the entire contract.

2. **Contractor Responsibilities:** Contractor will obtain all required permits or licenses, if any; furnish all of the required materials, equipment, and supplies; perform all of the work specified in the bid package; and do everything called for therein. All work shall be performed in a good and workmanlike manner and at minimal interruption of daily County activities.

3. **Payment for Services:** The County, upon satisfactory work by Contractor and receipt of approved invoice, will pay Contractor according to prices and payment schedule listed in the bid sheets contained in Contractor's Bid Proposal.

4. **Independent Contractor:** None of the provisions of this contract for services are intended to create, nor shall be deemed to create, any relationship between Galveston County and Contractor other than that of independent entities contracting with each other solely for the purpose of effecting the provisions of this Contract. In the performance of work, duties and obligations under this agreement, Contractor is at all times acting and performing as an independent contractor with complete control over the means, manner, and method by which services are rendered. Contractor is not an agent or employee of the County for any purpose. Contractor and his employees are not eligible for nor will be permitted to participate in any employee benefit plans which are normally provided to employees of the County, including vacation and sick leave, retirement plans, disability and worker's compensation. County assumes no liability to any third party for any actions, inactions or deeds taken in the performance of services by Contractor, its agents, employees or representatives.

5. **Employment Taxes:** Contractor shall be solely responsible for all IRS tax reporting and quarterly payments of estimated tax, FICA payments, and any other tax withholding required by the State or Federal governments.

6. **Initial Term and Options to Renew:** The initial term of the Contract will be as stated above. Contractor hereby grants to County the unilateral right to exercise an option to renew this Contract for such periods of time as specified above. Such option to renew shall be exercised only if all terms and conditions, except for the contract period being extended and pricing indicated on bid sheets, remain unchanged and in full force and effect. Each option is to be executed in the form of a letter from the County Purchasing Agent advising the Contractor of the election of the option. Each option is to be issued not sooner than Ninety (90) Days prior to expiration of this contract or each renewal period, nor later than the final day of the contract period or each renewal period. Each option to renew may not cover more than one (1) year. The total period of this contract, including all extensions as a result of exercising this option, may not exceed the maximum combined period specified above.

7. **Cancellation:** County may cancel the Contract, with or without cause, or solely for its convenience upon thirty (30) days prior written notice to the Contractor.

8. **Covenant Against Contingent Fees:** Contractor warrants that no persons or selling agency has been employed or retained to solicit or secure this contract upon an agreement or understanding for a commission, percentage, brokerage, or contingent fee, excepting bona fide employees or bona fide established commercial selling agencies maintained by the Contractor for the purpose of securing business. For breach or violation of this warranty, County shall have the right to immediately terminate this Contract without liability to Contractor, or in its discretion to deduct from the contract price for consideration, or otherwise recover the full amount of such commission, percentage, brokerage, or contingent fee.

9. **Subcontracting or Assignment:** Contractor may not assign, sell, or otherwise transfer this Contract in whole or in part without prior written permission of the County. Such consent, if granted, shall not relieve the Contractor of any of its responsibilities under the contract. Failure to request consent shall be grounds for termination.

10. **Novation and Change of Name Agreements:** Contractor is responsible for the performance of this Contract. In the event a change of name or novation agreement (change of ownership) is required pursuant to action initiated by the Contractor, the County Purchasing Agent shall be notified immediately. No change in the obligation of the Contractor will be recognized until such change is approved by Commissioners' Court.

11. **Force Majeure:** In the event that the performance by the County of any of its obligations or undertakings hereunder shall be interrupted or delayed by any occurrence not occasioned by its own conduct, whether such occurrence by an act of God or the common enemy or the result of war, riot, civil commotion, sovereign conduct, or the act or conduct of any person or persons not a party or privy hereto, then it shall be excused from such performance for such period of time as is reasonably necessary after such occurrence to remedy the effects thereof.

12. **Entirety of Agreement and Modification:** This Contract contains the entire agreement of the parties. Any prior agreement, promise, negotiation, or representation not expressly set forth in this Contract has no force or effect. This Contract may be amended or changed only by the written consent of each party hereto duly executed by the authorized representative of each party.

13. **Severability.** If a provision contained in this contract is held invalid for any reason, the invalidity shall not affect other provisions of the contract that can be given effect without the invalid provision, and to this end the provisions of this Contract are severable.

14. **Validity/Enforceability:** If any current or future legal limitations affect the validity or enforceability of a provision of this Contract, then the legal limitations are made a part of this Contract and shall operate to amend this contract to the minimum extent necessary to bring this contract into conformity with the requirements of the limitation, and as so modified, this Contract shall continue in full force and effect.

15. **Governing Law:** This Contract shall be governed by the laws of the State of Texas and all obligations of the parties are performable in Galveston, Texas. Venue shall lie exclusively in Galveston, Texas.

16. **Benefit:** This contract is intended to inure only to the benefit of County and Contractor. This contract is not intended to create, nor shall be deemed or construed to create, any rights in third parties.

17. **Authority to Bind:** The person or persons executing and signing this Contract on behalf of each party guarantee that the person or persons are fully authorized to execute the contract and to legally bind the party to all terms and provisions of this contract, and that this contract constitutes the legal, valid, and binding agreement of each party hereto.

18. **Immunity Retained:** The County does not waive or relinquish any immunity or defense on behalf of itself, its trustees, officer, employees, and agents as a result of its execution of this contract and performance of the covenants contained herein. The County specifically reserves any claim it may have to sovereign, qualified, or official immunity as a defense to any action arising in conjunction with this contract.

19. **Meaning of Words:** Except as provided otherwise, words shall be given their ordinary meaning. If a word is connected with and used with reference to a particular trade or subject matter or is used as a word of art, the word shall have the meaning given by experts in the particular trade, subject matter, or art. Words in the present or past tense include the future tense. The singular includes the plural and the plural includes the singular unless expressly provided otherwise.

20. **Public Information Act:** the parties agree that the County is a governmental body for purposes of the Public Information Act, codified as Chapter 552 of the Texas Government Code and as such is required to release information in accordance with the Public Information Act.

21. **Headings:** The headings at the beginning of the various provisions of this agreement have been included only in order to make it easier to locate the subject covered by each provision and are not to be used in construing this agreement.

22. **Conflict of Provisions:** In the event of an irreconcilable conflict between provision of this Contract and any part of the Contract listed in Paragraph One above, the terms of this Contract shall prevail.

Executed on this the _____ day of _____, 2015.

Contractor:

By:

Date:

Galveston County

By:

Date:

Mark A. Henry, County Judge

Attest:

Dwight Sullivan, County Clerk

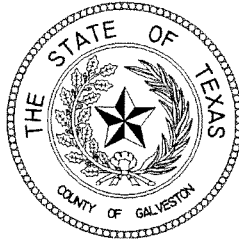

State of Texas

County of Galveston

Contract

This Contract is entered into between the County of Galveston, a political subdivision of the State of Texas and the Contractor named below pursuant to Texas Local Government Code, Chapter 262, Subchapter C and the referenced invitation to bid.

Contract Number: CM15211

Invitation to Bid Number: Bid# B152013 Sheriff Department Uniforms & Supplies

Term of Contract: One (1) year with two (2) one (1) year extensions

Initial term (Services): Beginning date of the contract will be _____. The contract will terminate on _____.

Term of Completion (Construction or other time specific contract): The Contractor shall complete the work within N/A Calendar Days of the issuance of the notice to proceed. The time set forth for completion of the work is an essential element of the job.

Renewal Options: (if applicable):

Year One: Yes (X) No ()
Year Two: Yes (X) No ()
Year Three: Yes () No (X)
Year Four: Yes () No (X)

Contractor: _____

Awarded as to addendum(s) (if applicable):

Addendum No. 1: () yes () no () n.a.
Addendum No. 2: () yes () no () n.a.
Addendum No. 3: () yes () no () n.a.

Payment Bond Required: () yes (X) no

Performance Bond Required: () yes (X) no

Notice to be Given to:

Galveston County:

County Purchasing Agent
Galveston County
722 Moody
Fifth (5th) Floor
Galveston, Texas 77550

Contractor:

County and Contractor agree as follows:

1. **Parts of Contract:** Sections I (Invitation to Bid; Instructions to Bidders), II (Bid Proposal; Contract Award), III (Special Terms and Conditions, including Specifications, Drawings and Addenda, if any), and IV (General Terms and Conditions) attached to this Contract Award are all made a part of this Contract and collectively evidence and constitute the entire contract.

2. **Contractor Responsibilities:** Contractor will obtain all required permits or licenses, if any; furnish all of the required materials, equipment, and supplies; perform all of the work specified in the bid package; and do everything called for therein. All work shall be performed in a good and workmanlike manner and at minimal interruption of daily County activities.

3. **Payment for Services:** The County, upon satisfactory work by Contractor and receipt of approved invoice, will pay Contractor according to prices and payment schedule listed in the bid sheets contained in Contractor's Bid Proposal.

4. **Independent Contractor:** None of the provisions of this contract for services are intended to create, nor shall be deemed to create, any relationship between Galveston County and Contractor other than that of independent entities contracting with each other solely for the purpose of effecting the provisions of this Contract. In the performance of work, duties and obligations under this agreement, Contractor is at all times acting and performing as an independent contractor with complete control over the means, manner, and method by which services are rendered. Contractor is not an agent or employee of the County for any purpose. Contractor and his employees are not eligible for nor will be permitted to participate in any employee benefit plans which are normally provided to employees of the County, including vacation and sick leave, retirement plans, disability and worker's compensation. County assumes no liability to any third party for any actions, inactions or deeds taken in the performance of services by Contractor, its agents, employees or representatives.

5. **Employment Taxes:** Contractor shall be solely responsible for all IRS tax reporting and quarterly payments of estimated tax, FICA payments, and any other tax withholding required by the State or Federal governments.

6. **Initial Term and Options to Renew:** The initial term of the Contract will be as stated above. Contractor hereby grants to County the unilateral right to exercise an option to renew this Contract for such periods of time as specified above. Such option to renew shall be exercised only if all terms and conditions, except for the contract period being extended and pricing indicated on bid sheets, remain unchanged and in full force and effect. Each option is to be executed in the form of a letter from the County Purchasing Agent advising the Contractor of the election of the option. Each option is to be issued not sooner than Ninety (90) Days prior to expiration of this contract or each renewal period, nor later than the final day of the contract period or each renewal period. Each option to renew may not cover more than one (1) year. The total period of this contract, including all extensions as a result of exercising this option, may not exceed the maximum combined period specified above.

7. **Cancellation:** County may cancel the Contract, with or without cause, or solely for its convenience upon thirty (30) days prior written notice to the Contractor.

8. **Covenant Against Contingent Fees:** Contractor warrants that no persons or selling agency has been employed or retained to solicit or secure this contract upon an agreement or understanding for a commission, percentage, brokerage, or contingent fee, excepting bona fide employees or bona fide established commercial selling agencies maintained by the Contractor for the purpose of securing business. For breach or violation of this warranty, County shall have the right to immediately terminate this Contract without liability to Contractor, or in its discretion to deduct from the contract price for consideration, or otherwise recover the full amount of such commission, percentage, brokerage, or contingent fee.

9. **Subcontracting or Assignment:** Contractor may not assign, sell, or otherwise transfer this Contract in whole or in part without prior written permission of the County. Such consent, if granted, shall not relieve the Contractor of any of its responsibilities under the contract. Failure to request consent shall be grounds for termination.

10. **Novation and Change of Name Agreements:** Contractor is responsible for the performance of this Contract. In the event a change of name or novation agreement (change of ownership) is required pursuant to action initiated by the Contractor, the County Purchasing Agent shall be notified immediately. No change in the obligation of the Contractor will be recognized until such change is approved by Commissioners' Court.

11. **Force Majeure:** In the event that the performance by the County of any of its obligations or undertakings hereunder shall be interrupted or delayed by any occurrence not occasioned by its own conduct, whether such occurrence by an act of God or the common enemy or the result of war, riot, civil commotion, sovereign conduct, or the act or conduct of any person or persons not a party or privy hereto, then it shall be excused from such performance for such period of time as is reasonably necessary after such occurrence to remedy the effects thereof.

12. **Entirety of Agreement and Modification:** This Contract contains the entire agreement of the parties. Any prior agreement, promise, negotiation, or representation not expressly set forth in this Contract has no force or effect. This Contract may be amended or changed only by the written consent of each party hereto duly executed by the authorized representative of each party.

13. **Severability.** If a provision contained in this contract is held invalid for any reason, the invalidity shall not affect other provisions of the contract that can be given effect without the invalid provision, and to this end the provisions of this Contract are severable.

14. **Validity/Enforceability:** If any current or future legal limitations affect the validity or enforceability of a provision of this Contract, then the legal limitations are made a part of this Contract and shall operate to amend this contract to the minimum extent necessary to bring this contract into conformity with the requirements of the limitation, and as so modified, this Contract shall continue in full force and effect.

15. **Governing Law:** This Contract shall be governed by the laws of the State of Texas and all obligations of the parties are performable in Galveston, Texas. Venue shall lie exclusively in Galveston, Texas.

16. **Benefit:** This contract is intended to inure only to the benefit of County and Contractor. This contract is not intended to create, nor shall be deemed or construed to create, any rights in third parties.

17. **Authority to Bind:** The person or persons executing and signing this Contract on behalf of each party guarantee that the person or persons are fully authorized to execute the contract and to legally bind the party to all terms and provisions of this contract, and that this contract constitutes the legal, valid, and binding agreement of each party hereto.

18. **Immunity Retained:** The County does not waive or relinquish any immunity or defense on behalf of itself, its trustees, officer, employees, and agents as a result of its execution of this contract and performance of the covenants contained herein. The County specifically reserves any claim it may have to sovereign, qualified, or official immunity as a defense to any action arising in conjunction with this contract.

19. **Meaning of Words:** Except as provided otherwise, words shall be given their ordinary meaning. If a word is connected with and used with reference to a particular trade or subject matter or is used as a word of art, the word shall have the meaning given by experts in the particular trade, subject matter, or art. Words in the present or past tense include the future tense. The singular includes the plural and the plural includes the singular unless expressly provided otherwise.

20. **Public Information Act:** the parties agree that the County is a governmental body for purposes of the Public Information Act, codified as Chapter 552 of the Texas Government Code and as such is required to release information in accordance with the Public Information Act.

21. **Headings:** The headings at the beginning of the various provisions of this agreement have been included only in order to make it easier to locate the subject covered by each provision and are not to be used in construing this agreement.

22. **Conflict of Provisions:** In the event of an irreconcilable conflict between provision of this Contract and any part of the Contract listed in Paragraph One above, the terms of this Contract shall prevail.

Executed on this the _____ day of _____, 2015.

Contractor:

By:

Date:

Galveston County

By:

Date:

Mark A. Henry, County Judge

Attest:

Dwight Sullivan, County Clerk

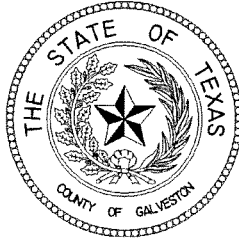

State of Texas

County of Galveston

Contract

This Contract is entered into between the County of Galveston, a political subdivision of the State of Texas and the Contractor named below pursuant to Texas Local Government Code, Chapter 262, Subchapter C and the referenced invitation to bid.

Contract Number: CM15211

Invitation to Bid Number: Bid# B152013 Sheriff Department Uniforms & Supplies

Term of Contract: One (1) year with two (2) one (1) year extensions

Initial term (Services): Beginning date of the contract will be _____. The contract will terminate on _____.

Term of Completion (Construction or other time specific contract): The Contractor shall complete the work within N/A Calendar Days of the issuance of the notice to proceed. The time set forth for completion of the work is an essential element of the job.

Renewal Options: (if applicable):

Year One: Yes (X) No ()
Year Two: Yes (X) No ()
Year Three: Yes () No (X)
Year Four: Yes () No (X)

Contractor: _____

Awarded as to addendum(s) (if applicable):

Addendum No. 1: () yes () no () n.a.
Addendum No. 2: () yes () no () n.a.
Addendum No. 3: () yes () no () n.a.

Payment Bond Required: () yes (X) no

Performance Bond Required: () yes (X) no

Notice to be Given to:

Galveston County:

County Purchasing Agent
Galveston County
722 Moody
Fifth (5th) Floor
Galveston, Texas 77550

Contractor:

County and Contractor agree as follows:

1. **Parts of Contract:** Sections I (Invitation to Bid; Instructions to Bidders), II (Bid Proposal; Contract Award), III (Special Terms and Conditions, including Specifications, Drawings and Addenda, if any), and IV (General Terms and Conditions) attached to this Contract Award are all made a part of this Contract and collectively evidence and constitute the entire contract.

2. **Contractor Responsibilities:** Contractor will obtain all required permits or licenses, if any; furnish all of the required materials, equipment, and supplies; perform all of the work specified in the bid package; and do everything called for therein. All work shall be performed in a good and workmanlike manner and at minimal interruption of daily County activities.

3. **Payment for Services:** The County, upon satisfactory work by Contractor and receipt of approved invoice, will pay Contractor according to prices and payment schedule listed in the bid sheets contained in Contractor's Bid Proposal.

4. **Independent Contractor:** None of the provisions of this contract for services are intended to create, nor shall be deemed to create, any relationship between Galveston County and Contractor other than that of independent entities contracting with each other solely for the purpose of effecting the provisions of this Contract. In the performance of work, duties and obligations under this agreement, Contractor is at all times acting and performing as an independent contractor with complete control over the means, manner, and method by which services are rendered. Contractor is not an agent or employee of the County for any purpose. Contractor and his employees are not eligible for nor will be permitted to participate in any employee benefit plans which are normally provided to employees of the County, including vacation and sick leave, retirement plans, disability and worker's compensation. County assumes no liability to any third party for any actions, inactions or deeds taken in the performance of services by Contractor, its agents, employees or representatives.

5. **Employment Taxes:** Contractor shall be solely responsible for all IRS tax reporting and quarterly payments of estimated tax, FICA payments, and any other tax withholding required by the State or Federal governments.

6. **Initial Term and Options to Renew:** The initial term of the Contract will be as stated above. Contractor hereby grants to County the unilateral right to exercise an option to renew this Contract for such periods of time as specified above. Such option to renew shall be exercised only if all terms and conditions, except for the contract period being extended and pricing indicated on bid sheets, remain unchanged and in full force and effect. Each option is to be executed in the form of a letter from the County Purchasing Agent advising the Contractor of the election of the option. Each option is to be issued not sooner than Ninety (90) Days prior to expiration of this contract or each renewal period, nor later than the final day of the contract period or each renewal period. Each option to renew may not cover more than one (1) year. The total period of this contract, including all extensions as a result of exercising this option, may not exceed the maximum combined period specified above.

7. **Cancellation:** County may cancel the Contract, with or without cause, or solely for its convenience upon thirty (30) days prior written notice to the Contractor.

8. **Covenant Against Contingent Fees:** Contractor warrants that no persons or selling agency has been employed or retained to solicit or secure this contract upon an agreement or understanding for a commission, percentage, brokerage, or contingent fee, excepting bona fide employees or bona fide established commercial selling agencies maintained by the Contractor for the purpose of securing business. For breach or violation of this warranty, County shall have the right to immediately terminate this Contract without liability to Contractor, or in its discretion to deduct from the contract price for consideration, or otherwise recover the full amount of such commission, percentage, brokerage, or contingent fee.

9. **Subcontracting or Assignment:** Contractor may not assign, sell, or otherwise transfer this Contract in whole or in part without prior written permission of the County. Such consent, if granted, shall not relieve the Contractor of any of its responsibilities under the contract. Failure to request consent shall be grounds for termination.

10. **Novation and Change of Name Agreements:** Contractor is responsible for the performance of this Contract. In the event a change of name or novation agreement (change of ownership) is required pursuant to action initiated by the Contractor, the County Purchasing Agent shall be notified immediately. No change in the obligation of the Contractor will be recognized until such change is approved by Commissioners' Court.

11. **Force Majeure:** In the event that the performance by the County of any of its obligations or undertakings hereunder shall be interrupted or delayed by any occurrence not occasioned by its own conduct, whether such occurrence by an act of God or the common enemy or the result of war, riot, civil commotion, sovereign conduct, or the act or conduct of any person or persons not a party or privy hereto, then it shall be excused from such performance for such period of time as is reasonably necessary after such occurrence to remedy the effects thereof.

12. **Entirety of Agreement and Modification:** This Contract contains the entire agreement of the parties. Any prior agreement, promise, negotiation, or representation not expressly set forth in this Contract has no force or effect. This Contract may be amended or changed only by the written consent of each party hereto duly executed by the authorized representative of each party.

13. **Severability.** If a provision contained in this contract is held invalid for any reason, the invalidity shall not affect other provisions of the contract that can be given effect without the invalid provision, and to this end the provisions of this Contract are severable.

14. **Validity/Enforceability:** If any current or future legal limitations affect the validity or enforceability of a provision of this Contract, then the legal limitations are made a part of this Contract and shall operate to amend this contract to the minimum extent necessary to bring this contract into conformity with the requirements of the limitation, and as so modified, this Contract shall continue in full force and effect.

15. **Governing Law:** This Contract shall be governed by the laws of the State of Texas and all obligations of the parties are performable in Galveston, Texas. Venue shall lie exclusively in Galveston, Texas.

16. **Benefit:** This contract is intended to inure only to the benefit of County and Contractor. This contract is not intended to create, nor shall be deemed or construed to create, any rights in third parties.

17. **Authority to Bind:** The person or persons executing and signing this Contract on behalf of each party guarantee that the person or persons are fully authorized to execute the contract and to legally bind the party to all terms and provisions of this contract, and that this contract constitutes the legal, valid, and binding agreement of each party hereto.

18. **Immunity Retained:** The County does not waive or relinquish any immunity or defense on behalf of itself, its trustees, officer, employees, and agents as a result of its execution of this contract and performance of the covenants contained herein. The County specifically reserves any claim it may have to sovereign, qualified, or official immunity as a defense to any action arising in conjunction with this contract.

19. **Meaning of Words:** Except as provided otherwise, words shall be given their ordinary meaning. If a word is connected with and used with reference to a particular trade or subject matter or is used as a word of art, the word shall have the meaning given by experts in the particular trade, subject matter, or art. Words in the present or past tense include the future tense. The singular includes the plural and the plural includes the singular unless expressly provided otherwise.

20. **Public Information Act:** the parties agree that the County is a governmental body for purposes of the Public Information Act, codified as Chapter 552 of the Texas Government Code and as such is required to release information in accordance with the Public Information Act.

21. **Headings:** The headings at the beginning of the various provisions of this agreement have been included only in order to make it easier to locate the subject covered by each provision and are not to be used in construing this agreement.

22. **Conflict of Provisions:** In the event of an irreconcilable conflict between provision of this Contract and any part of the Contract listed in Paragraph One above, the terms of this Contract shall prevail.

Executed on this the _____ day of _____, 2015.

Contractor:

By:

Date:

Galveston County

By:

Date:

Mark A. Henry, County Judge

Attest:

Dwight Sullivan, County Clerk

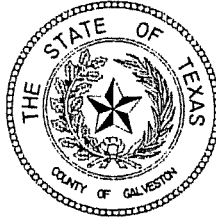

County of Galveston Purchasing Department Vendor Qualification Packet

(rev. 1.2, March 29, 2010)

All interested parties seeking consideration for qualified vendor status with the County of Galveston should complete and return only the following attached forms to:

Galveston County Purchasing Department
722 Moody Avenue, (21st Street), 5th Floor
Galveston, Texas 77550
(409) 770-5371 office
(409) 621-7987 fax

- Form PEID:** Person /Entity Information Data
Form W-9: Request for Taxpayer Identification Number and Certification
(please note that the included form may not be the latest revised form issued by the Internal Revenue Service. Please check the IRS website at <http://www.irs.gov/pub/irs-pdf/fw9.pdf> for the latest revision of this form.)
Form CIQ: Conflict of Interest Questionnaire
(please note that the included form may not be the latest revised form issued by the State of Texas Ethics Commission. Please check the Texas Ethics Commission website at for the latest revision of this form. Please note that Galveston County Purchasing Agent is not responsible for the filing of this form with the Galveston County Clerk per instructions of the State of Texas Ethics Commission).

Certificate(s) of Insurance: If the person or entity seeking qualified vendor status with the County will be performing work at or on any County owned facility and/or property, Certificate(s) of Insurance are required to be submitted prior to performing any work.

Insurance requirements are as follows:

Public Liability and Property Damage Insurance:

Successful vendor agrees to keep in full force and effect, a policy of public liability and property damage insurance issued by a casualty company authorized to do business in the State of Texas, and in standard form approved by the Board of Insurance Commissioners of the State of Texas, with coverage provisions insuring the public from any loss or damage that may arise to any person or property by reason of services rendered by vendor. Vendor shall at its own expense be required to carry the following minimum insurance coverages:

- For damages arising out of bodily injury to or death of one person in any one occurrence – one hundred thousand and no/100 dollars (\$100,000.00);
- For damages arising out of bodily injury to or death of two or more persons in any one occurrence – three hundred thousand and no/100 dollars (\$300,000.00); and
- For injury to or destruction of property in any one occurrence – one hundred thousand and no/100 dollars (\$100,000.00).

This insurance shall be either on an occurrence basis or on a claims made basis. Provided however, that if the coverage is on a claims made basis, then the vendor shall be required to purchase, at the termination of this agreement, tail coverage for the County for the period of the County's relationship with the vendor under this agreement. Such coverage shall be in the amounts set forth in subparagraphs (1), (2), and (3) above.

Worker's Compensation Insurance:

Successful vendor shall also carry in full force Workers' Compensation Insurance policy(ies), if there is more than one employee, for all employees, including but not limited to full time, part time, and emergency employees employed by the vendor. Current insurance certificates certifying that such policies as specified above are in full force and effect shall be furnished by the vendor to the County.

The County of Galveston shall be named as additional insured on policies listed in subparagraphs above and shall be notified of any changes to the policy(ies) during the contractual period. Insurance is to be placed with insurers having a Best rating of no less than A. The vendor shall furnish the County with certificates of insurance and original endorsements affecting coverage required by these insurance clauses. The certificates and endorsements for each insurance policy are to be signed by a person authorized by the insurer to bind coverage on its behalf. The vendor shall be required to submit annual renewals for the term of any contractual agreement, purchase order or term contract, with Galveston County prior to expiration of any policy.

In addition to the remedies stated herein, the County has the right to pursue other remedies permitted by law or in equity.

The County agrees to provide vendor with reasonable and timely notice of any claim, demand, or cause of action made or brought against the County arising out of or related to utilization of the property. Vendor shall have the right to defend any such claim, demand, or cause of action at its sole cost and expense and within its sole and exclusive discretion. The County agrees not to compromise or settle any claim or cause of action arising out of or related to the utilization of the property without the prior written consent of the vendor.

In no event shall the County be liable for any damage to or destruction of any property belonging to the vendor unless specified in writing and agreed upon by both parties.

Procurement Policy - Special Note:

Understand that it is, according to Texas Local Government Code, Section 262.011, Purchasing Agents, subsections (d), (e), and (f), the sole responsibility of the Purchasing Agent to supervise all procurement transactions.

Therefore, be advised that all procurement transactions require proper authorization in the form of a Galveston County purchase order from the Purchasing Agent's office prior to commitment to deliver supplies, materials, equipment, including contracts for repair, service, and maintenance agreements. Any commitments made without proper authorization from the Purchasing Agent's office, pending Commissioners' Court approval, may become the sole responsibility of the individual making the commitment including the obligation of payment.

Code of Ethics - Statement of Purchasing Policy:

Public employment is a public trust. It is the policy of Galveston County to promote and balance the objective of protecting the County's integrity and the objective of facilitating the recruitment and

retention of personnel needed by Galveston County. Such policy is implemented by prescribing essential standards of ethical conduct without creating unnecessary obstacles to entering public office.

Public employees must discharge their duties impartially so as to assure fair competitive access to governmental procurement by responsible contractors. Moreover, they should conduct themselves in such a manner as to foster public confidence in the integrity of the Galveston County procurement organization.

To achieve the purpose of these instructions, it is essential that those doing business with Galveston County also observe the ethical standards prescribed here.

General Ethical Standards: It shall be a breach of ethics to attempt to realize personal gain through public employment with Galveston County by any conduct inconsistent with the proper discharge of the employee's duties.

It shall be a breach of ethics to attempt to influence any public employee of Galveston County to breach the standards of ethical conduct set forth in this code.

It shall be a breach of ethics for any employee of Galveston County to participate directly or indirectly in procurement when the employee knows that:

- The employee or any member of the employee's immediate family has a financial interest pertaining to the procurement.
- A business or organization in which the employee, or any member of the employee's immediate family, has a financial interest pertaining to the procurement.
- Any other person, business or organization with which the employee or any member of the employee's immediate family is negotiating or has an arrangement concerning prospective employment is involved in the procurement.

Gratuities: It shall be a breach of ethics to offer, give or agree to give any employee of Galveston County, or for any employee or former employee of Galveston County to solicit, demand, accept or agree to accept from another person, a gratuity or an offer of employment in connection with any decision, approval, disapproval, recommendation, preparation of any part of a program requirement or purchase request, influencing the content of any specification or procurement standard, rendering of advice, investigation, auditing, or in any other advisory capacity in any program requirement or a contract or subcontract, or to any solicitation or proposal therefore pending before this government.

Kickbacks: It shall be a breach of ethics for any payment, gratuity or offer of employment to be made by or on behalf of a subcontractor under a contract to the prime contractor or higher tier subcontractor for any contract for Galveston County, or any person associated therewith, as an inducement for the award of a subcontract or order.

Contract Clause: The prohibition against gratuities and kickbacks prescribed above shall be conspicuously set forth in every contract and solicitation by Galveston County.

Confidential Information: It shall be a breach of ethics for any employee or former employee of Galveston County to knowingly use confidential information for actual or anticipated personal gain, or for the actual or anticipated gain of any person.

Questions/Concerns:

If you have any questions or concerns regarding the information or instructions contained within this packet, please contact any member of the Purchasing Department staff at (409) 770-5371.

CONFLICT OF INTEREST DISCLOSURE REPORTING

Proposer may be required under Chapter 176 of the Texas Local Government Code to complete and file a conflict of interest questionnaire (CIQ Form). If so, the completed CIQ Form must be filed with the County Clerk of Galveston County, Texas.

If Proposer has an employment or other business relationship with an officer of Galveston County or with a family member of an officer of Galveston County that results in the officer or family member of the officer receiving taxable income that exceeds \$2,500.00 during the preceding 12-month period, then Proposer **MUST** complete a CIQ Form and file the original of the CIQ Form with the County Clerk of Galveston County.

If Proposer has given an officer of Galveston County or a family member of an officer of Galveston County one or more gifts with an aggregate value of more than \$250.00 during the preceding 12-months, then Proposer **MUST** complete a CIQ Form and file the original of the CIQ Form with the County Clerk of Galveston County.

The Galveston County Clerk has offices at the following locations:

Galveston County Clerk
Galveston County Justice Center, Suite 2001
600 59th Street
Galveston, Texas 77551

Galveston County Clerk
North County Annex, 1st Floor
174 Calder Road
League City, Texas 77573

Again, if Proposer is required to file a CIQ Form, the original completed form is filed with the Galveston County Clerk (not the Purchasing Agent).

For Proposer's convenience, a blank CIQ Form is enclosed with this proposal. Blank CIQ Forms may also be obtained by visiting the Galveston County Clerk's website and/or the Purchasing Agent's website – both of these web sites are linked to the Galveston County homepage, at <http://www.co.galveston.tx.us>.

As well, blank CIQ Forms may be obtained by visiting the Texas Ethics Commission website, specifically at http://www.ethics.state.tx.us/whatsnew/conflict_forms.htm.

Chapter 176 specifies deadlines for the filing of CIQ Forms (both initial filings and updated filings).

It is Proposer's sole responsibility to file a true and complete CIQ Form with the Galveston County Clerk if Proposer is required to file by the requirements of Chapter 176. Proposer is advised that it is an offense to fail to comply with the disclosure reporting requirements dictated under Chapter 176 of the Texas Local Government Code.

If you have questions about compliance with Chapter 176, please consult your own legal counsel. Compliance is the individual responsibility of each person, business, and agent who is subject to Chapter 176 of the Texas Local Government Code.

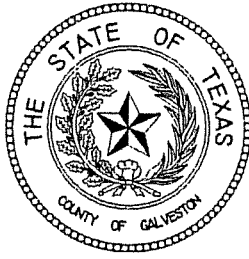

COUNTY of GALVESTON
Purchasing Department

rev. 1.3, March 29, 2010

FORM PEID:	Request for Person-Entity Identification Data
-------------------	--

Instructions: Please type or print clearly when completing sections 1 thru 4 and return completed form to:

Galveston County Purchasing Agent
722 Moody Avenue (21st. Street), 5th Floor
Galveston, Texas 77550
(409) 770-5371 office
(409) 621-7987 fax

1.

Business Name:			
Attention Line:			

2.

Physical Address:			
City:		State:	Zip+4:

3.

Billing / Remit Address:			
City:		State:	Zip+4

4.

Main Contact Person:			
Main Phone Number:			
Fax Number:			
E-mail Address:			

Areas below are for County use only.

Requested By:	Phone / Ext. #
Department:	Date:

Action Requested - Check One:	IFAS PEID Vendor Number:	
<input type="checkbox"/> Add New	<input type="checkbox"/> Change Data	<input type="checkbox"/> Re-activate
<input type="checkbox"/> Inactivate	<input type="checkbox"/> Employee	<input type="checkbox"/> Attorney
<input type="checkbox"/> Landlord	<input type="checkbox"/> Foster Parent	<input type="checkbox"/> Refund
<input type="checkbox"/> One Time	<input type="checkbox"/> Foster Child	

Request for Taxpayer Identification Number and Certification

Give form to the
requester. Do not
send to the IRS.

Print or type
See Specific Instructions on page 2.

Name (as shown on your income tax return)	
Business name, if different from above	
Check appropriate box: <input type="checkbox"/> Individual/Sole proprietor <input type="checkbox"/> Corporation <input type="checkbox"/> Partnership <input type="checkbox"/> Limited liability company. Enter the tax classification (D=disregarded entity, C=corporation, P=partnership) ▶ <input type="checkbox"/> Exempt payee <input type="checkbox"/> Other (see Instructions) ▶	
Address (number, street, and apt. or suite no.)	Requester's name and address (optional)
City, state, and ZIP code	
List account number(s) here (optional)	

Part I Taxpayer Identification Number (TIN)

Enter your TIN in the appropriate box. The TIN provided must match the name given on Line 1 to avoid backup withholding. For individuals, this is your social security number (SSN). However, for a resident alien, sole proprietor, or disregarded entity, see the Part I instructions on page 3. For other entities, it is your employer identification number (EIN). If you do not have a number, see *How to get a TIN* on page 3.

Social security number
or
Employer identification number

Note. If the account is in more than one name, see the chart on page 4 for guidelines on whose number to enter.

Part II Certification

Under penalties of perjury, I certify that:

1. The number shown on this form is my correct taxpayer identification number (or I am waiting for a number to be issued to me), and
2. I am not subject to backup withholding because: (a) I am exempt from backup withholding, or (b) I have not been notified by the Internal Revenue Service (IRS) that I am subject to backup withholding as a result of a failure to report all interest or dividends, or (c) the IRS has notified me that I am no longer subject to backup withholding, and
3. I am a U.S. citizen or other U.S. person (defined below).

Certification Instructions. You must cross out item 2 above if you have been notified by the IRS that you are currently subject to backup withholding because you have failed to report all interest and dividends on your tax return. For real estate transactions, item 2 does not apply. For mortgage interest paid, acquisition or abandonment of secured property, cancellation of debt, contributions to an individual retirement arrangement (IRA), and generally, payments other than interest and dividends, you are not required to sign the Certification, but you must provide your correct TIN. See the instructions on page 4.

Sign Here	Signature of U.S. person ▶	Date ▶
------------------	----------------------------	--------

General Instructions

Section references are to the Internal Revenue Code unless otherwise noted.

Purpose of Form

A person who is required to file an information return with the IRS must obtain your correct taxpayer identification number (TIN) to report, for example, income paid to you, real estate transactions, mortgage interest you paid, acquisition or abandonment of secured property, cancellation of debt, or contributions you made to an IRA.

Use Form W-9 only if you are a U.S. person (including a resident alien), to provide your correct TIN to the person requesting it (the requester) and, when applicable, to:

1. Certify that the TIN you are giving is correct (or you are waiting for a number to be issued),
2. Certify that you are not subject to backup withholding, or
3. Claim exemption from backup withholding if you are a U.S. exempt payee. If applicable, you are also certifying that as a U.S. person, your allocable share of any partnership income from a U.S. trade or business is not subject to the withholding tax on foreign partners' share of effectively connected income.

Note. If a requester gives you a form other than Form W-9 to request your TIN, you must use the requester's form if it is substantially similar to this Form W-9.

Definition of a U.S. person. For federal tax purposes, you are considered a U.S. person if you are:

- An individual who is a U.S. citizen or U.S. resident alien,
- A partnership, corporation, company, or association created or organized in the United States or under the laws of the United States,
- An estate (other than a foreign estate), or
- A domestic trust (as defined in Regulations section 301.7701-7).

Special rules for partnerships. Partnerships that conduct a trade or business in the United States are generally required to pay a withholding tax on any foreign partners' share of income from such business. Further, in certain cases where a Form W-9 has not been received, a partnership is required to presume that a partner is a foreign person, and pay the withholding tax. Therefore, if you are a U.S. person that is a partner in a partnership conducting a trade or business in the United States, provide Form W-9 to the partnership to establish your U.S. status and avoid withholding on your share of partnership income.

The person who gives Form W-9 to the partnership for purposes of establishing its U.S. status and avoiding withholding on its allocable share of net income from the partnership conducting a trade or business in the United States is in the following cases:

- The U.S. owner of a disregarded entity and not the entity,

- The U.S. grantor or other owner of a grantor trust and not the trust, and
- The U.S. trust (other than a grantor trust) and not the beneficiaries of the trust.

Foreign person. If you are a foreign person, do not use Form W-9. Instead, use the appropriate Form W-8 (see Publication 515, Withholding of Tax on Nonresident Aliens and Foreign Entities).

Nonresident alien who becomes a resident alien. Generally, only a nonresident alien individual may use the terms of a tax treaty to reduce or eliminate U.S. tax on certain types of income. However, most tax treaties contain a provision known as a "saving clause." Exceptions specified in the saving clause may permit an exemption from tax to continue for certain types of income even after the payee has otherwise become a U.S. resident alien for tax purposes.

If you are a U.S. resident alien who is relying on an exception contained in the saving clause of a tax treaty to claim an exemption from U.S. tax on certain types of income, you must attach a statement to Form W-9 that specifies the following five items:

1. The treaty country. Generally, this must be the same treaty under which you claimed exemption from tax as a nonresident alien.
2. The treaty article addressing the income.
3. The article number (or location) in the tax treaty that contains the saving clause and its exceptions.
4. The type and amount of income that qualifies for the exemption from tax.
5. Sufficient facts to justify the exemption from tax under the terms of the treaty article.

Example. Article 20 of the U.S.-China income tax treaty allows an exemption from tax for scholarship income received by a Chinese student temporarily present in the United States. Under U.S. law, this student will become a resident alien for tax purposes if his or her stay in the United States exceeds 5 calendar years. However, paragraph 2 of the first Protocol to the U.S.-China treaty (dated April 30, 1984) allows the provisions of Article 20 to continue to apply even after the Chinese student becomes a resident alien of the United States. A Chinese student who qualifies for this exception (under paragraph 2 of the first protocol) and is relying on this exception to claim an exemption from tax on his or her scholarship or fellowship income would attach to Form W-9 a statement that includes the information described above to support that exemption.

If you are a nonresident alien or a foreign entity not subject to backup withholding, give the requester the appropriate completed Form W-8.

What is backup withholding? Persons making certain payments to you must under certain conditions withhold and pay to the IRS 28% of such payments. This is called "backup withholding." Payments that may be subject to backup withholding include interest, tax-exempt interest, dividends, broker and barter exchange transactions, rents, royalties, nonemployee pay, and certain payments from fishing boat operators. Real estate transactions are not subject to backup withholding.

You will not be subject to backup withholding on payments you receive if you give the requester your correct TIN, make the proper certifications, and report all your taxable interest and dividends on your tax return.

Payments you receive will be subject to backup withholding if:

1. You do not furnish your TIN to the requester,
2. You do not certify your TIN when required (see the Part II instructions on page 3 for details),
3. The IRS tells the requester that you furnished an incorrect TIN,

4. The IRS tells you that you are subject to backup withholding because you did not report all your interest and dividends on your tax return (for reportable interest and dividends only), or

5. You do not certify to the requester that you are not subject to backup withholding under 4 above (for reportable interest and dividend accounts opened after 1983 only).

Certain payees and payments are exempt from backup withholding. See the instructions below and the separate Instructions for the Requester of Form W-9.

Also see *Special rules for partnerships* on page 1.

Penalties

Failure to furnish TIN. If you fail to furnish your correct TIN to a requester, you are subject to a penalty of \$50 for each such failure unless your failure is due to reasonable cause and not to willful neglect.

Civil penalty for false information with respect to withholding. If you make a false statement with no reasonable basis that results in no backup withholding, you are subject to a \$500 penalty.

Criminal penalty for falsifying information. Willfully falsifying certifications or affirmations may subject you to criminal penalties including fines and/or imprisonment.

Misuse of TINs. If the requester discloses or uses TINs in violation of federal law, the requester may be subject to civil and criminal penalties.

Specific Instructions

Name

If you are an individual, you must generally enter the name shown on your income tax return. However, if you have changed your last name, for instance, due to marriage without informing the Social Security Administration of the name change, enter your first name, the last name shown on your social security card, and your new last name.

If the account is in joint names, list first, and then circle, the name of the person or entity whose number you entered in Part I of the form.

Sole proprietor. Enter your individual name as shown on your income tax return on the "Name" line. You may enter your business, trade, or "doing business as (DBA)" name on the "Business name" line.

Limited liability company (LLC). Check the "Limited liability company" box only and enter the appropriate code for the tax classification ("D" for disregarded entity, "C" for corporation, "P" for partnership) in the space provided.

For a single-member LLC (including a foreign LLC with a domestic owner) that is disregarded as an entity separate from its owner under Regulations section 301.7701-3, enter the owner's name on the "Name" line. Enter the LLC's name on the "Business name" line.

For an LLC classified as a partnership or a corporation, enter the LLC's name on the "Name" line and any business, trade, or DBA name on the "Business name" line.

Other entities. Enter your business name as shown on required federal tax documents on the "Name" line. This name should match the name shown on the charter or other legal document creating the entity. You may enter any business, trade, or DBA name on the "Business name" line.

Note. You are requested to check the appropriate box for your status (individual/sole proprietor, corporation, etc.).

Exempt Payee

If you are exempt from backup withholding, enter your name as described above and check the appropriate box for your status, then check the "Exempt payee" box in the line following the business name, sign and date the form.

Generally, individuals (including sole proprietors) are not exempt from backup withholding. Corporations are exempt from backup withholding for certain payments, such as interest and dividends.

Note. If you are exempt from backup withholding, you should still complete this form to avoid possible erroneous backup withholding.

The following payees are exempt from backup withholding:

1. An organization exempt from tax under section 501(a), any IRA, or a custodial account under section 403(b)(7) if the account satisfies the requirements of section 401(f)(2),
2. The United States or any of its agencies or instrumentalities,
3. A state, the District of Columbia, a possession of the United States, or any of their political subdivisions or instrumentalities,
4. A foreign government or any of its political subdivisions, agencies, or instrumentalities, or
5. An international organization or any of its agencies or instrumentalities.

Other payees that may be exempt from backup withholding include:

6. A corporation,
7. A foreign central bank of issue,
8. A dealer in securities or commodities required to register in the United States, the District of Columbia, or a possession of the United States,
9. A futures commission merchant registered with the Commodity Futures Trading Commission,
10. A real estate investment trust,
11. An entity registered at all times during the tax year under the Investment Company Act of 1940,
12. A common trust fund operated by a bank under section 584(a),
13. A financial institution,
14. A middleman known in the investment community as a nominee or custodian, or
15. A trust exempt from tax under section 664 or described in section 4947.

The chart below shows types of payments that may be exempt from backup withholding. The chart applies to the exempt payees listed above, 1 through 15.

IF the payment is for . . .	THEN the payment is exempt for . . .
Interest and dividend payments	All exempt payees except for 9
Broker transactions	Exempt payees 1 through 13. Also, a person registered under the Investment Advisers Act of 1940 who regularly acts as a broker
Barter exchange transactions and patronage dividends	Exempt payees 1 through 5
Payments over \$600 required to be reported and direct sales over \$5,000 ¹	Generally, exempt payees 1 through 7 ²

¹See Form 1099-MISC, Miscellaneous Income, and Its Instructions.

²However, the following payments made to a corporation (including gross proceeds paid to an attorney under section 6045(f), even if the attorney is a corporation) and reportable on Form 1099-MISC are not exempt from backup withholding: medical and health care payments, attorneys' fees, and payments for services paid by a federal executive agency.

Part I. Taxpayer Identification Number (TIN)

Enter your TIN in the appropriate box. If you are a resident alien and you do not have and are not eligible to get an SSN, your TIN is your IRS individual taxpayer identification number (ITIN). Enter it in the social security number box. If you do not have an ITIN, see *How to get a TIN* below.

If you are a sole proprietor and you have an EIN, you may enter either your SSN or EIN. However, the IRS prefers that you use your SSN.

If you are a single-member LLC that is disregarded as an entity separate from its owner (see *Limited liability company (LLC)* on page 2), enter the owner's SSN (or EIN, if the owner has one). Do not enter the disregarded entity's EIN. If the LLC is classified as a corporation or partnership, enter the entity's EIN.

Note. See the chart on page 4 for further clarification of name and TIN combinations.

How to get a TIN. If you do not have a TIN, apply for one immediately. To apply for an SSN, get Form SS-5, Application for a Social Security Card, from your local Social Security Administration office or get this form online at www.ssa.gov. You may also get this form by calling 1-800-772-1213. Use Form W-7, Application for IRS Individual Taxpayer Identification Number, to apply for an ITIN, or Form SS-4, Application for Employer Identification Number, to apply for an EIN. You can apply for an EIN online by accessing the IRS website at www.irs.gov/businesses and clicking on Employer Identification Number (EIN) under Starting a Business. You can get Forms W-7 and SS-4 from the IRS by visiting www.irs.gov or by calling 1-800-TAX-FORM (1-800-829-3676).

If you are asked to complete Form W-9 but do not have a TIN, write "Applied For" in the space for the TIN, sign and date the form, and give it to the requester. For interest and dividend payments, and certain payments made with respect to readily tradable instruments, generally you will have 60 days to get a TIN and give it to the requester before you are subject to backup withholding on payments. The 60-day rule does not apply to other types of payments. You will be subject to backup withholding on all such payments until you provide your TIN to the requester.

Note. Entering "Applied For" means that you have already applied for a TIN or that you intend to apply for one soon.

Caution: A disregarded domestic entity that has a foreign owner must use the appropriate Form W-8.

Part II. Certification

To establish to the withholding agent that you are a U.S. person, or resident alien, sign Form W-9. You may be requested to sign by the withholding agent even if items 1, 4, and 5 below indicate otherwise.

For a joint account, only the person whose TIN is shown in Part I should sign (when required). Exempt payees, see *Exempt Payee* on page 2.

Signature requirements. Complete the certification as indicated in 1 through 5 below.

1. Interest, dividend, and barter exchange accounts opened before 1984 and broker accounts considered active during 1983. You must give your correct TIN, but you do not have to sign the certification.

2. Interest, dividend, broker, and barter exchange accounts opened after 1983 and broker accounts considered inactive during 1983. You must sign the certification or backup withholding will apply. If you are subject to backup withholding and you are merely providing your correct TIN to the requester, you must cross out item 2 in the certification before signing the form.

3. Real estate transactions. You must sign the certification. You may cross out item 2 of the certification.

4. Other payments. You must give your correct TIN, but you do not have to sign the certification unless you have been notified that you have previously given an incorrect TIN. "Other payments" include payments made in the course of the requester's trade or business for rents, royalties, goods (other than bills for merchandise), medical and health care services (including payments to corporations), payments to a nonemployee for services, payments to certain fishing boat crew members and fishermen, and gross proceeds paid to attorneys (including payments to corporations).

5. Mortgage interest paid by you, acquisition or abandonment of secured property, cancellation of debt, qualified tuition program payments (under section 529), IRA, Coverdell ESA, Archer MSA or HSA contributions or distributions, and pension distributions. You must give your correct TIN, but you do not have to sign the certification.

What Name and Number To Give the Requester

For this type of account:	Give name and SSN of:
1. Individual	The individual
2. Two or more individuals (joint account)	The actual owner of the account or, if combined funds, the first individual on the account ¹
3. Custodian account of a minor (Uniform Gift to Minors Act)	The minor ²
4. a. The usual revocable savings trust (grantor is also trustee)	The grantor-trustee ³
b. So-called trust account that is not a legal or valid trust under state law	The actual owner ¹
5. Sole proprietorship or disregarded entity owned by an individual	The owner ³
For this type of account:	Give name and EIN of:
6. Disregarded entity not owned by an individual	The owner
7. A valid trust, estate, or pension trust	Legal entity ⁴
8. Corporate or LLC electing corporate status on Form 8832	The corporation
9. Association, club, religious, charitable, educational, or other tax-exempt organization	The organization
10. Partnership or multi-member LLC	The partnership
11. A broker or registered nominee	The broker or nominee
12. Account with the Department of Agriculture in the name of a public entity (such as a state or local government, school district, or prison) that receives agricultural program payments	The public entity

¹ List first and circle the name of the person whose number you furnish. If only one person on a joint account has an SSN, that person's number must be furnished.

² Circle the minor's name and furnish the minor's SSN.

³ You must show your individual name and you may also enter your business or "DBA" name on the second name line. You may use either your SSN or EIN (if you have one), but the IRS encourages you to use your SSN.

⁴ List first and circle the name of the trust, estate, or pension trust. (Do not furnish the TIN of the personal representative or trustee unless the legal entity itself is not designated in the account title.) Also see *Special rules for partnerships* on page 1.

Note. If no name is circled when more than one name is listed, the number will be considered to be that of the first name listed.

Privacy Act Notice

Section 6109 of the Internal Revenue Code requires you to provide your correct TIN to persons who must file information returns with the IRS to report interest, dividends, and certain other income paid to you, mortgage interest you paid, the acquisition or abandonment of secured property, cancellation of debt, or contributions you made to an IRA, or Archer MSA or HSA. The IRS uses the numbers for identification purposes and to help verify the accuracy of your tax return. The IRS may also provide this information to the Department of Justice for civil and criminal litigation, and to cities, states, the District of Columbia, and U.S. possessions to carry out their tax laws. We may also disclose this information to other countries under a tax treaty, to federal and state agencies to enforce federal nontax criminal laws, or to federal law enforcement and intelligence agencies to combat terrorism.

You must provide your TIN whether or not you are required to file a tax return. Payers must generally withhold 28% of taxable interest, dividend, and certain other payments to a payee who does not give a TIN to a payer. Certain penalties may also apply.

Secure Your Tax Records from Identity Theft

Identity theft occurs when someone uses your personal information such as your name, social security number (SSN), or other identifying information, without your permission, to commit fraud or other crimes. An identity thief may use your SSN to get a job or may file a tax return using your SSN to receive a refund.

To reduce your risk:

- Protect your SSN,
- Ensure your employer is protecting your SSN, and
- Be careful when choosing a tax preparer.

Call the IRS at 1-800-829-1040 if you think your identity has been used inappropriately for tax purposes.

Victims of identity theft who are experiencing economic harm or a system problem, or are seeking help in resolving tax problems that have not been resolved through normal channels, may be eligible for Taxpayer Advocate Service (TAS) assistance. You can reach TAS by calling the TAS toll-free case intake line at 1-877-777-4778 or TTY/TDD 1-800-829-4059.

Protect yourself from suspicious emails or phishing schemes.

Phishing is the creation and use of email and websites designed to mimic legitimate business emails and websites. The most common act is sending an email to a user falsely claiming to be an established legitimate enterprise in an attempt to scam the user into surrendering private information that will be used for identity theft.

The IRS does not initiate contacts with taxpayers via emails. Also, the IRS does not request personal detailed information through email or ask taxpayers for the PIN numbers, passwords, or similar secret access information for their credit card, bank, or other financial accounts.

If you receive an unsolicited email claiming to be from the IRS, forward this message to phishing@irs.gov. You may also report misuse of the IRS name, logo, or other IRS personal property to the Treasury Inspector General for Tax Administration at 1-800-366-4484. You can forward suspicious emails to the Federal Trade Commission at: spam@uce.gov or contact them at www.consumer.gov/idtheft or 1-877-IDTHEFT(438-4338).

Visit the IRS website at www.irs.gov to learn more about identity theft and how to reduce your risk.

CONFLICT OF INTEREST QUESTIONNAIRE

FORM CIQ

For vendor or other person doing business with local governmental entity

This questionnaire reflects changes made to the law by H.B. 1491, 80th Leg., Regular Session.

This questionnaire is being filed in accordance with Chapter 176, Local Government Code by a person who has a business relationship as defined by Section 176.001(1-a) with a local governmental entity and the person meets requirements under Section 176.006(a).

By law this questionnaire must be filed with the records administrator of the local governmental entity not later than the 7th business day after the date the person becomes aware of facts that require the statement to be filed. See Section 176.006, Local Government Code.

A person commits an offense if the person knowingly violates Section 176.006, Local Government Code. An offense under this section is a Class C misdemeanor.

OFFICE USE ONLY

Date Received

1 Name of person who has a business relationship with local governmental entity.

2 Check this box if you are filing an update to a previously filed questionnaire.

(The law requires that you file an updated completed questionnaire with the appropriate filing authority not later than the 7th business day after the date the originally filed questionnaire becomes incomplete or inaccurate.)

3 Name of local government officer with whom filer has employment or business relationship.

Name of Officer

This section (item 3 including subparts A, B, C & D) must be completed for each officer with whom the filer has an employment or other business relationship as defined by Section 176.001(1-a), Local Government Code. Attach additional pages to this Form CIQ as necessary.

A. Is the local government officer named in this section receiving or likely to receive taxable income, other than investment income, from the filer of the questionnaire?

Yes No

B. Is the filer of the questionnaire receiving or likely to receive taxable income, other than investment income, from or at the direction of the local government officer named in this section AND the taxable income is not received from the local governmental entity?

Yes No

C. Is the filer of this questionnaire employed by a corporation or other business entity with respect to which the local government officer serves as an officer or director, or holds an ownership of 10 percent or more?

Yes No

D. Describe each employment or business relationship with the local government officer named in this section.

4

Signature of person doing business with the governmental entity

Date